

2004 SPORTSMAN

Owner's Manual
for Vehicle Maintenance
and Safety



POLARIS
The Way Out.



**Read this manual carefully. It contains important safety information.
This is an adult vehicle only.
Operation is prohibited for those under 16 years of age.**

! WARNING

Improper vehicle use can result in SEVERE INJURY or DEATH.



**ALWAYS USE
AN APPROVED
HELMET AND
PROTECTIVE
GEAR**



**NEVER USE
ON PUBLIC
ROADS**



**NEVER CARRY
PASSENGERS**



**NEVER USE
WITH DRUGS
OR ALCOHOL**

NEVER:

- Operate without proper training or instruction.
- Operate on public roads. A collision can occur with another vehicle.
- Operate at speeds too fast for your skills or the conditions.
- Use **ALCOHOL** or **DRUGS** before or while operating this vehicle.
- Carry Passengers.

ALWAYS:

- Avoid paved surfaces, which may adversely affect handling and control.
- Use proper **RIDING TECHNIQUES** to avoid vehicle overturns on hills and rough terrain, and in turns.
- Wear eye protection, helmet and protective apparel.

**READ OWNER'S MANUAL.
FOLLOW ALL INSTRUCTIONS AND WARNINGS.**

 **WARNING**

The engine exhaust from this product contains chemicals known to cause cancer, birth defects or other reproductive harm.

A card containing important ATV safety information should be attached to the owner's manual on the next page. If you cannot locate this card, or if it has been removed, please call 1-800-342-3764 for assistance.

We've created a web site just for YOU!

- Technical tips
- New product introductions
- Event schedules
- Parts and Service Manual information
- Exciting details about The Way Out

Check it out...

www.polarisindustries.com/owner



POLARIS®
The Way Out.

Copyright 2003 Polaris Sales Inc. All information contained within this publication is based on the latest product information at the time of publication. Due to constant improvements in the design and quality of production components, some minor discrepancies may result between the actual vehicle and the information presented in this publication. Depictions and/or procedures in this publication are intended for reference use only. No liability can be accepted for omissions or inaccuracies. Any reprinting or reuse of the depictions and/or procedures contained within, whether whole or in part, is expressly prohibited. Printed in U.S.A.

WELCOME

Thank you for purchasing a Polaris vehicle, and welcome to our world-wide family of Polaris owners. We proudly produce an exciting line of utility and recreational products.

Polaris Recreational Vehicles

- Snowmobiles
- All-terrain vehicles (ATVs)
- Watercraft
- *RANGER* utility vehicles
- Victory motorcycles

Polaris Professional Series Workmobiles™

- Utility Task Vehicles™ (UTVs)
- Personal Task Vehicles™ (PTVs)
- All-Surface Loaders (ASLs)

We believe Polaris sets a standard of excellence for all utility and recreational vehicles manufactured in the world today. Many years of experience have gone into the engineering, design, and development of your Polaris vehicle, making it the finest machine we've ever produced.

For safe and enjoyable operation of your vehicle, be sure to follow the instructions and recommendations in this owner's manual. Your manual contains instructions for minor maintenance, but information about major repairs is outlined in the Polaris Service Manual and should be performed only by a Factory Certified Master Service Dealer (MSD) Technician.

Your Polaris dealer knows your vehicle best and is interested in your total satisfaction. Be sure to return to your dealership for all of your service needs during, and after, the warranty period.

We also take great pride in our Parts Apparel and Accessories (PAA) products, available through our online store at www.purepolaris.com. Have your accessories and clothing delivered right to your door!

Polaris, Polaris The Way Out, and Workmobiles are registered trademarks of Polaris Industries Inc.

VEHICLE IDENTIFICATION NUMBERS

The frame vehicle identification number (VIN)(1) and engine serial number (2) are important for model identification when registering your vehicle, when obtaining insurance, and when ordering replacement parts. In the event your vehicle is stolen, these numbers are essential to the recovery and identification of your vehicle.

Remove the spare key and store it in a safe place. Your key can be duplicated only by mating a Polaris key blank with one of your existing keys. If both keys are lost, the ignition switch must be replaced. See your Polaris dealer.

NOTE: Record your vehicle's ID numbers and key number (3) in the spaces provided.

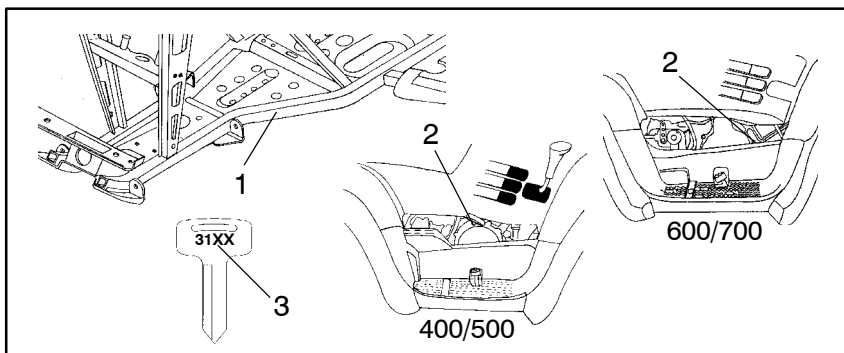

Frame VIN:

Vehicle Model Number:

Engine Serial Number:

Key Number:

TABLE OF CONTENTS

WELCOME	3
VEHICLE IDENTIFICATION NUMBERS	4
SAFETY	6
CONTROLS	36
FEATURES	44
OPERATION	50
EMISSION CONTROL SYSTEMS	68
MAINTENANCE AND LUBRICATION	69
ADJUSTMENTS	112
POLARIS PRODUCTS	115
TROUBLESHOOTING	116
SPECIFICATIONS	120
WARRANTY	128
INDEX	133

SAFETY

Safety Decals and Locations

Warning decals have been placed on the ATV for your protection. Read and follow the instructions of the decals on the ATV carefully. If any of the decals depicted in this manual differ from the decals on your ATV, always read and follow the instructions of the decals *on the ATV*.

If any decal becomes illegible or comes off, contact your Polaris dealer to purchase a replacement. Replacement *safety* decals are provided by Polaris at no charge. The part number is printed on the decal.

⚠ WARNING

Improper ATV use can result in **SEVERE INJURY** or **DEATH**



ALWAYS USE AN APPROVED HELMET AND PROTECTIVE GEAR **NEVER USE ON PUBLIC ROADS** **NEVER CARRY PASSENGERS** **NEVER USE WITH DRUGS OR ALCOHOL**

NEVER operate:

- without proper training or instruction
- at speeds too fast for your skills or the conditions
- on public roads - a collision can occur with another vehicle
- with a passenger - passengers affect balance and steering and increase risk of losing control

ALWAYS:

- use proper riding techniques to avoid vehicle overturns on hills and rough terrain and in turns
- avoid paved surfaces - pavement may seriously affect handling and control

LOCATE AND READ OWNER'S MANUAL.
FOLLOW ALL INSTRUCTIONS AND WARNINGS.
IF OWNER'S MANUAL IS MISSING, CONTACT A POLARIS DEALER FOR A REPLACEMENT.

©1997, 2000 7079083

⚠ WARNING



Operating this vehicle if you are under the age of 16 increases your chance of severe injury or death.

NEVER operate this vehicle if you are under age 16.

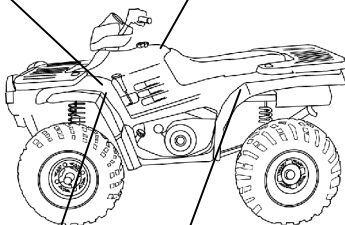

⚠ WARNING

NEVER ride as a passenger



Passengers can cause a loss of control, resulting in **SEVERE INJURY** or **DEATH**

7077920

⚠ WARNING

- Never operate this ATV on **HILLS** steeper than 25 degrees $\angle 25^\circ$. To prevent flipover on hilly terrain, when going up or down, use throttle and brakes gradually.
- **REVERSE** operation can be dangerous even at low speeds. Steering becomes difficult. To prevent flipover, avoid sudden braking or sharp turns.
- Use **VERRIDE** for reverse speed limiter with caution. To prevent loss of control, never activate override button with open throttle.
- When this ATV is not in operation or unattended, place shift in the park position.

7171383

Safety Decals and Locations

WARNING

IMPROPER TIRE PRESSURE OR OVERLOADING can cause loss of control resulting in SEVERE INJURY OR DEATH.

TIRE PRESSURE IN PSI (KPa): FRONT 5 (34,5) REAR 5 (34,5)

MAXIMUM WEIGHT CAPACITY (Gross Vehicle Weight) INCLUDING MACHINE, DRIVER AND CARGO IS 1200 LBS. (545 kg).

Reduce speed and allow greater distance for braking when carrying cargo. Overloading or carrying tall, off-center, or unsecured loads will increase your risk of losing control. Loads should be centered, carried as low as possible, and firmly secured to the racks. With dual racks, load distribution 1/3 front 2/3 rear is best. For stability on rough or hilly terrain, reduce speed and cargo. Do not block headlight. Be careful if load extends over the side of the rack.

Read Owner's Manual for more detailed loading information

7079084

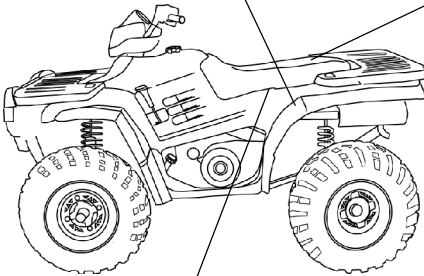

ATTENTION

- Operation of this vehicle without the air filter element will severely damage the engine.
- Clean pre-filter element often, more frequent cleaning required in dusty conditions. Do not operate vehicle without pre-filter.
- Operation of this vehicle without engine breather filter(s) can cause engine damage. Consult owner's manual or dealer for details.
- Specific carburetor jetting and adjustments are required depending on temperature and altitude. See your Owner's Manual.

Factory setting:
40° to 80° F. at 0-3000 feet
(5° to 27° C. at 0-900 meters).

7079902

SAFETY

Safety Decals and Locations

⚠ WARNING

Moving parts hazard under belt-clutch guard. To prevent serious injury, do not operate vehicle with guard removed.

Do not modify engine or clutch. Doing so can cause part failure, possible imbalance, and excessive engine RPM which can result in serious injury or death.

7078689

NO STEP

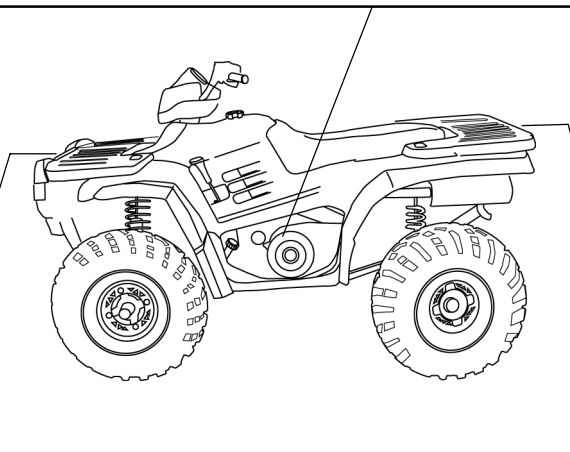

⚠ WARNING

- DO NOT TOW FROM RACK OR BUMPER. Vehicle damage or tipover may result causing severe injury or death. Tow only from tow hooks or hitch.

- Max Rack Loads: Front 90 lbs. (41 kg) Rear 180 lbs. (82 kg) 7170021

Sportsman 400/500

⚠ WARNING

- DO NOT TOW FROM RACK OR BUMPER. Vehicle damage or tipover may result causing severe injury or death. Tow only from tow hooks or hitch.

- Max Rack Loads: Front 100 lbs. (45 kg) Rear 200 lbs. (91 kg) 7170912

Sportsman 600/700

Safety Decals and Locations

▲ WARNING

Pushing reverse override button may cause sudden increases in power and traction if too much throttle is applied. Loss of control or forward flipover may result, especially in AWD. See Owner's Manual.

7079604

**ALL WHEEL
DRIVE
SWITCH**

Do not push switch to engage AWD if the rear wheels are spinning. This may cause severe drive shaft and clutch damage.
See your Owner's Manual.

7079780



**MANUFACTURED
BY: POLARIS IND. INC.**

DATE:

VIN:

**THIS VEHICLE IS AN ALL TERRAIN VEHICLE AND IS NOT
INTENDED FOR USE ON PUBLIC ROADS.**

**CE VÉHICULE EST UN VÉHICULE TOUT TERRAIN QUI N'EST
PAS DESTINÉ À ÊTRE UTILISÉ SUR LES CHEMINS PUBLICS.**

PATENT NOTICE Mfd. by All Terrain Vehicle Division,
Polaris Industries Inc. under one or more of the
following patents: Other patents pending, U.S. Patents

4697665	5036939	5975624
6016943	6092877	6149540
6224134	6270106	6340186
D378080	D389440	D400143



7171492

Canadian Certification Decal

TRAILER MAX WEIGHT:
1225 LBS. (557 KG) ON LEVEL GROUND
850 LBS. (386 KG) UP TO 15° GRADE
HITCH MAX. VERTICAL WEIGHT: 120 LBS. (55KG)

7170911

Sportsman 400/500

TRAILER MAX WEIGHT:
1500 LBS. (682 KG) ON LEVEL GROUND
850 LBS. (386 KG) UP TO 15° GRADE
HITCH MAX. VERTICAL WEIGHT: 150 LBS. (68KG)

7170509

Sportsman 600/700

SAFETY

Safe Riding Gear

Always wear clothing suited to the type of riding. ATV riding requires special protective clothing for comfort and to reduce the chance of injury.

1. Helmet

Your helmet is the most important piece of protective gear for safe riding. A helmet can prevent a severe head injury.

Select an approved helmet that meets or exceeds your state's safety standards and bears either the Department of Transportation (DOT) label, the American National Standards Institute label (ANSI z90.1), or the Snell Memorial Foundation label.

2. Eye Protection

Do not depend on sunglasses for proper eye protection. A pair of goggles or a helmet face shield offer the best protection for your eyes. They should be kept clean and be of shatterproof design (bearing the markings Z2.1 or VESC 8).

3. Gloves

Off-road style gloves with knuckle pads are the best for comfort and protection.

4. Boots

The best footwear is a pair of strong over-the-calf boots with heels, like moto-cross boots.

5. Clothing

Always wear long sleeves and long pants to protect arms and legs. Riding pants with kneepads and a jersey with shoulder pads provide the best protection.

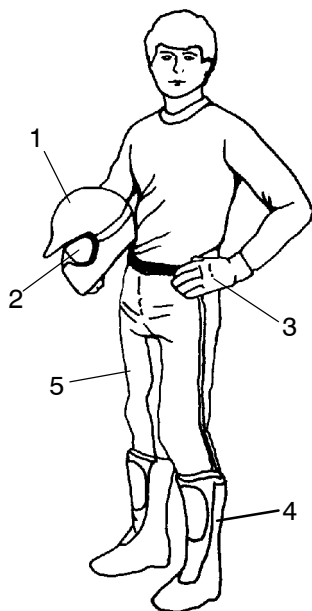

Operator Safety

WARNING

Failure to follow the warnings contained in this manual can result in severe injury or death.

A Polaris ATV is not a toy and can be hazardous to operate. This vehicle handles differently than other vehicles, such as motorcycles and cars. A collision or rollover can occur quickly, even during routine maneuvers like turning, or driving on hills or over obstacles, if you fail to take proper precautions.

Read and understand your owner's manual and all warnings before operating a Polaris ATV.

Age Restrictions

This vehicle is an **ADULT VEHICLE ONLY**. Operation is prohibited for anyone under 16 years of age.

Know Your Vehicle

As the operator of the vehicle, you are responsible for your personal safety, the safety of others, and the protection of our environment. Read and understand your owner's manual, which includes valuable information about all aspects of your vehicle, including safe operating procedures.

Safety Training

When you purchased your new ATV, your dealer offered a hands-on safety training course that covers all aspects of vehicle safety. You were also provided with printed materials that explain safe operating procedures. You should review this information on a regular basis.

If you purchased a used Polaris ATV from a party other than a Polaris dealer, you can request this free safety training from any authorized Polaris dealer.

A Polaris ATV is an off-road vehicle. Familiarize yourself with all laws and regulations concerning the operation of the ATV in your area.

We strongly advise you to strictly follow the recommended maintenance program outlined in your owner's manual. This preventive maintenance program is designed to ensure that all critical components on your vehicle are thoroughly inspected at specific intervals.

SAFETY

Operator Safety

The following two pages identify signal words and symbols that appear in this manual. Your safety is involved when these words and symbols are used. Become familiar with their meanings before reading the manual.



The *safety alert symbol*, on your vehicle or in this manual, alerts you to the potential for personal injury.

WARNING

The *safety alert warning* indicates a potential hazard that may result in serious injury or death.

CAUTION

The *safety alert caution* indicates a potential hazard that may result in minor personal injury or damage to the vehicle.

CAUTION

A *caution* indicates a situation that may result in damage to the vehicle.

NOTE:

A *note* will alert you to important information or instructions.

Operator Safety

WARNING

Serious injury or death can result if you do not follow these instructions and procedures, which are outlined in further detail within your owner's manual.

- Read this manual and all labels carefully, and follow the operating procedures described.
- Never operate an ATV without proper instruction. *Take a training course.* Beginners should receive training from a certified instructor. Contact an authorized Polaris ATV dealer or call Polaris at 1-800-342-3764 to find out about the training courses nearest you.
- Never allow anyone under 16 years of age to operate this ATV.
- Never permit a guest to operate the ATV unless the guest has read this manual and all product labels and has completed a certified safety training course.
- Always avoid operating an ATV on paved surfaces, including sidewalks, driveways, parking lots, and streets.
- Never operate an ATV on a public street, road or highway, including a dirt or gravel road.
- Never operate an ATV without wearing an approved helmet that fits properly. Always wear eye protection (goggles or face shield), gloves, boots, a long-sleeved shirt or jacket, and long pants.
- Never consume alcohol or drugs before or while operating an ATV.
- Never operate at excessive speeds. Travel at speeds appropriate for the terrain, visibility and operating conditions, and your experience.
- Never attempt wheelies, jumps or other stunts.
- Always inspect your ATV before each use to make sure it's in safe operating condition. Always follow the inspection and maintenance procedures and schedules outlined in your owner's manual.
- Always keep both hands on the handlebars and both feet on the footrests of the ATV during operation.
- Always travel slowly and use extra caution when operating on unfamiliar terrain. Be alert to changing terrain conditions.
- Never operate on excessively rough, slippery, or loose terrain.
- Always follow proper turning procedures as described in this manual. Practice turning at low speeds before attempting to turn at faster speeds. Do not turn at excessive speeds.

SAFETY

Operator Safety

- Always have the ATV inspected by an authorized Polaris dealer if it's been involved in an accident.
- Never operate on hills too steep for the ATV or for your abilities. Practice on smaller hills before attempting larger hills.
- Always follow proper procedures for climbing hills. Check the terrain carefully before ascending a hill. Never climb hills with excessively slippery or loose surfaces. Shift your weight forward. Never open the throttle suddenly or make sudden gear changes. Never go over the top of a hill at high speed.
- Always follow proper procedures for going downhill and for braking on hills. Check the terrain carefully before you start down a hill. Shift your weight backward. Never go down a hill at high speed. Avoid going down a hill at an angle, which would cause the vehicle to lean sharply to one side. Travel straight down the hill when possible.
- Always follow proper procedures for crossing the side of a hill. Avoid hills with excessively slippery or loose surfaces. Shift your weight to the uphill side of the ATV. Never attempt to turn the ATV around on any hill until you've mastered (on level ground) the turning technique outlined in this manual. Avoid crossing the side of a steep hill when possible.
- Always use proper procedures if you stall or roll backwards while climbing a hill. To avoid stalling, maintain a steady speed when climbing a hill. If you stall or roll backwards, follow the special procedure for braking described in this manual. Always dismount on the uphill side, or to either side if the ATV is pointed straight uphill. Turn the ATV around and remount following the procedure described in this manual.
- Always check for obstacles before operating in a new area. Never attempt to operate over large obstacles, such as rocks or fallen trees. Always follow proper procedures when operating over obstacles as described in this manual.
- Always be careful of skidding or sliding. On slippery surfaces like ice, travel slowly and use extra caution to reduce the chance of skidding or sliding out of control.
- Avoid operating the ATV through deep or fast-flowing water. If it's unavoidable, travel slowly, balance your weight carefully, avoid sudden movements, and maintain a slow and steady forward motion. Do not make sudden turns or stops, and do not make sudden throttle changes.

Operator Safety

- Wet brakes may have reduced stopping ability. Test the brakes after leaving water. If necessary, apply them lightly several times to allow friction to dry out the pads.
- Always check for obstacles or people behind the ATV before operating in reverse. When it's safe to proceed in reverse, move slowly and avoid turning at sharp angles.
- Always use the size and type of tires specified for your ATV, and always maintain proper tire pressure.
- Never modify an ATV through improper installation or use of accessories.
- Never exceed the stated load capacity for your ATV. Cargo must be properly distributed and securely attached. Reduce speed and follow the instructions in this manual for carrying cargo or towing. Allow a greater distance for braking.

FOR MORE INFORMATION ABOUT ATV SAFETY, call the Consumer Product Safety Commission at 1-800-638-2772, or call Polaris at 1-800-342-3764.

Equipment Modifications

We are concerned for the safety of our customers and for the general public. Therefore, we strongly recommend that consumers do not install on a Polaris ATV any equipment that may increase the speed or power of the vehicle, or make any other modifications to the vehicle for these purposes. Any modifications to the original equipment of the vehicle create a substantial safety hazard and increase the risk of bodily injury.

The warranty on your Polaris ATV is terminated if any equipment has been added to the vehicle, or if any modifications have been made to the vehicle, that increase its speed or power.

NOTE: The addition of certain accessories, including (but not limited to) mowers, blades, tires, sprayers, or large racks, may change the handling characteristics of the vehicle. Use only Polaris-approved accessories, and familiarize yourself with their function and effect on the vehicle.

SAFETY

Operator Safety

WARNING

POTENTIAL HAZARD

Operating this ATV without proper instruction.

WHAT CAN HAPPEN

The risk of an accident is greatly increased if the operator does not know how to operate the ATV properly in different situations and on different types of terrain.

HOW TO AVOID THE HAZARD

Beginning and inexperienced operators should complete the certified training course offered by Polaris. Operators should regularly practice the skills learned in the course and the operating techniques described in the owner's manual.

For more information about the training course, contact an authorized ATV dealer or call Polaris at 1-800-342-3764.

WARNING

POTENTIAL HAZARD

Failure to follow the age recommendations for this ATV.

WHAT CAN HAPPEN

Severe injury and/or death could occur if a child under the minimum age recommendation operates an ATV.

Even though a child may be within the recommended age group for operating some ATVs, he/she may not have the skills, abilities, or judgment needed to operate an ATV safely and could be susceptible to accident or injury.

HOW TO AVOID THE HAZARD

No one under the age of 16 should operate a Polaris ATV.

Operator Safety

⚠ WARNING



POTENTIAL HAZARD

Carrying a passenger on an ATV.

WHAT CAN HAPPEN

Carrying a passenger greatly reduces the operator's ability to balance and control the ATV, which could cause an accident and injury to the operator and/or passenger.

HOW TO AVOID THE HAZARD

Never carry a passenger. The purpose of the long seat is to allow the operator to shift position as needed during operation. It is not intended for carrying passengers.

SAFETY

Operator Safety

⚠ WARNING

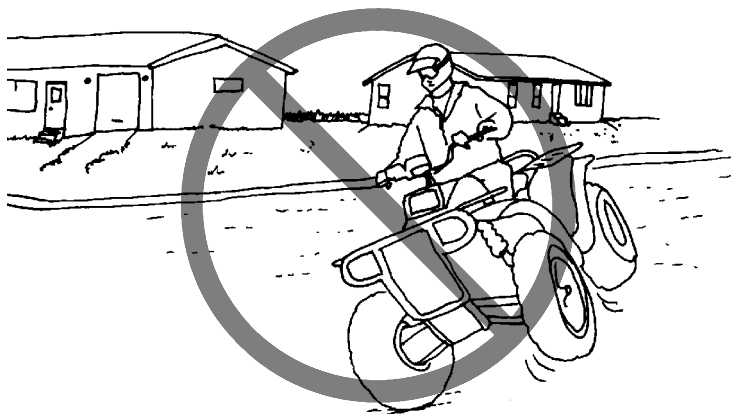

POTENTIAL HAZARD

Operating an ATV on paved surfaces, including sidewalks, paths, parking lots, and driveways.

WHAT CAN HAPPEN

ATV tires are designed for off-road use. Operating on paved surfaces may adversely affect the handling of the ATV and could result in loss of control, accident, and/or injury.

HOW TO AVOID THE HAZARD

Avoid operating the ATV on pavement. If it's unavoidable, travel slowly and avoid sudden turns or stops.

Operator Safety

⚠ WARNING

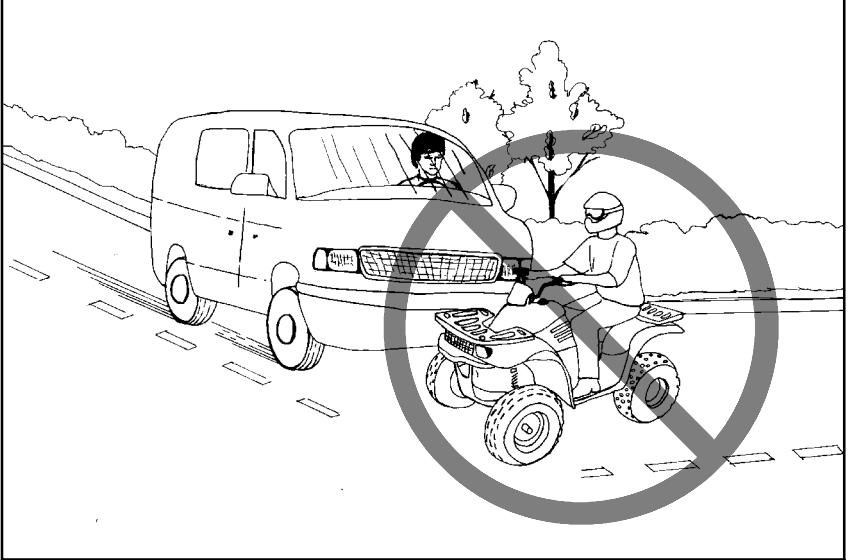

POTENTIAL HAZARD

Operating this ATV on public streets, roads or highways.

WHAT CAN HAPPEN

The ATV could collide with another vehicle.

HOW TO AVOID THE HAZARD

Never operate the ATV on any public street, road or highway, including dirt and gravel roads. In many states it's illegal to operate ATVs on public streets, roads and highways.

SAFETY

Operator Safety

⚠ WARNING

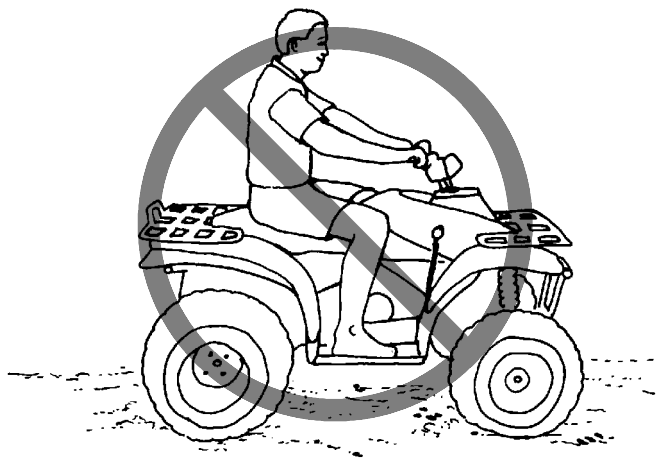

POTENTIAL HAZARD

Operating this ATV without wearing an approved helmet, eye protection and protective clothing.

WHAT CAN HAPPEN

Operating an ATV without an approved helmet increases the risk of a severe head injury or death in the event of an accident.

Operating without eye protection could result in an accident and could increase the chance of a severe injury in the event of an accident.

HOW TO AVOID THE HAZARD

Always wear an approved helmet that fits properly.

Always wear eye protection (goggles or face shield), gloves, boots, long-sleeved shirt or jacket, and long pants.

Operator Safety

WARNING

POTENTIAL HAZARD

Operating the ATV after consuming alcohol or drugs.

WHAT CAN HAPPEN

Consumption of alcohol and/or drugs could seriously affect operator judgment. Reaction time may be slower and operator balance and perception could be affected.

Consuming alcohol and/or drugs before or while operating an ATV could result in an accident causing severe injury or death.

HOW TO AVOID THE HAZARD

Never consume alcohol or drugs before or while operating an ATV.

WARNING

POTENTIAL HAZARD

Operating the ATV at excessive speeds.

WHAT CAN HAPPEN

Excessive speed increases the operator's chance of losing control of the ATV, which can result in an accident causing severe injury or death.

HOW TO AVOID THE HAZARD

Always operate the ATV at a speed that's proper for the terrain, visibility and operating conditions, and your experience.

SAFETY

Operator Safety

⚠ WARNING

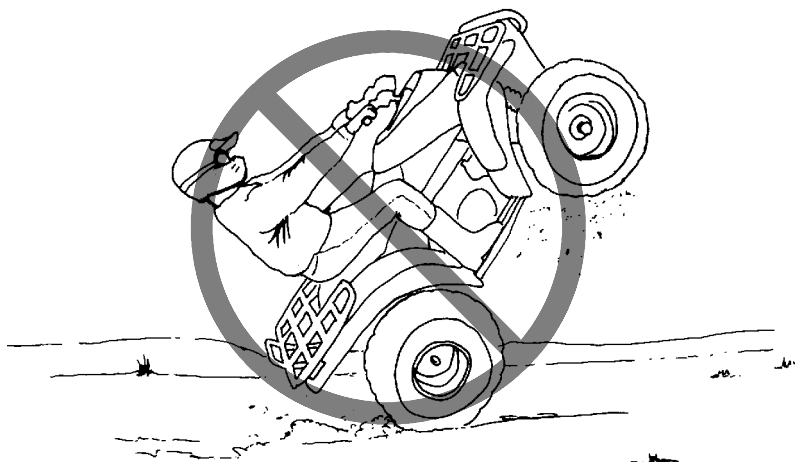

POTENTIAL HAZARD

Attempting wheelies, jumps and other stunts.

WHAT CAN HAPPEN

Attempting stunts increases the chance of an accident, including an overturn.

HOW TO AVOID THE HAZARD

Never attempt wheelies, jumps, or other stunts. Avoid exhibition driving.

Operator Safety

WARNING

POTENTIAL HAZARD

Failure to inspect the ATV before operating.

Failure to properly maintain the ATV.

WHAT CAN HAPPEN

Poor maintenance increases the possibility of an accident or equipment damage.

HOW TO AVOID THE HAZARD

Always inspect your ATV before each use to make sure it's in safe operating condition.

Always follow the inspection and maintenance procedures and schedules described in the owner's manual.

WARNING

POTENTIAL HAZARD

Removing hands from the handlebars or feet from the footrests during operation.

WHAT CAN HAPPEN

Removing even one hand or foot can reduce ability to control the vehicle or could cause loss of balance and ejection from the ATV.

If the operator's foot is not firmly planted on the footrest, it could come into contact with the rear wheels and lead to accident or injury.

HOW TO AVOID THE HAZARD

Always keep both hands on the handlebars and both feet on the footrests of the ATV during operation.

SAFETY

Operator Safety

⚠ WARNING

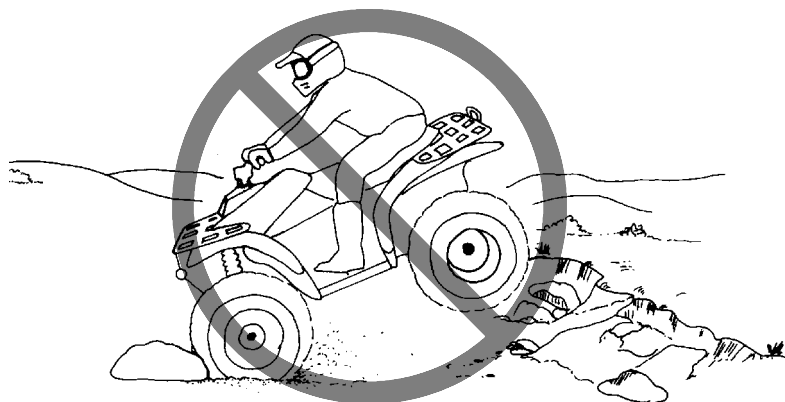

POTENTIAL HAZARD

Failure to use extra caution when operating the ATV on unfamiliar terrain.

WHAT CAN HAPPEN

Unfamiliar terrain may contain hidden rocks, bumps, or holes that could cause loss of control or overturn.

HOW TO AVOID THE HAZARD

Travel slowly and use extra caution when operating on unfamiliar terrain. Always be alert to changing terrain conditions.

Operator Safety

⚠ WARNING

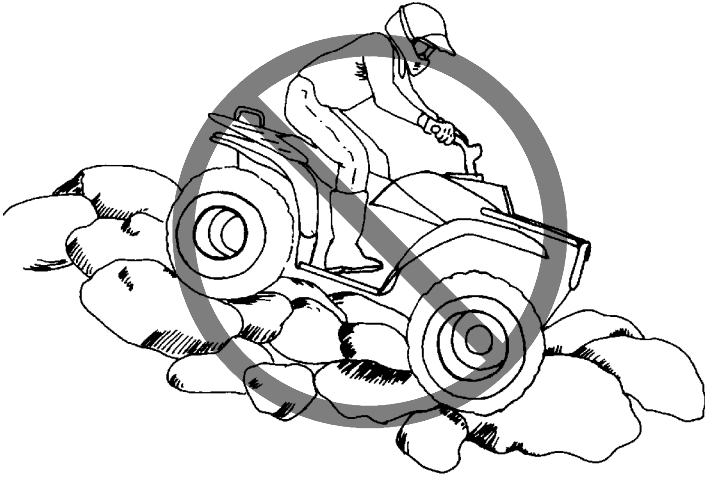

POTENTIAL HAZARD

Failure to use extra caution when operating on excessively rough, slippery or loose terrain.

WHAT CAN HAPPEN

Operating on excessively rough, slippery or loose terrain could cause loss of traction or loss of control, which could result in an accident or overturn.

HOW TO AVOID THE HAZARD

Do not operate on excessively rough, slippery or loose terrain until you've learned and practiced the skills necessary to control the ATV on such terrain.

Always use extra caution on rough, slippery or loose terrain.

SAFETY

Operator Safety

WARNING

POTENTIAL HAZARD

Turning improperly.

WHAT CAN HAPPEN

Improper turns could cause loss of control and lead to a collision or overturn.

HOW TO AVOID THE HAZARD

Always follow proper procedures for turning as described in the owner's manual.

Practice turning at slow speeds before attempting to turn at faster speeds.

Never turn at excessive speed.

WARNING

POTENTIAL HAZARD

Operating on excessively steep hills.

WHAT CAN HAPPEN

The vehicle may overturn.

HOW TO AVOID THE HAZARD

Never operate on hills too steep for the ATV or for your abilities. Never operate the ATV on hills steeper than 25°.

Practice on smaller hills before attempting large hills.

Operator Safety

⚠ WARNING

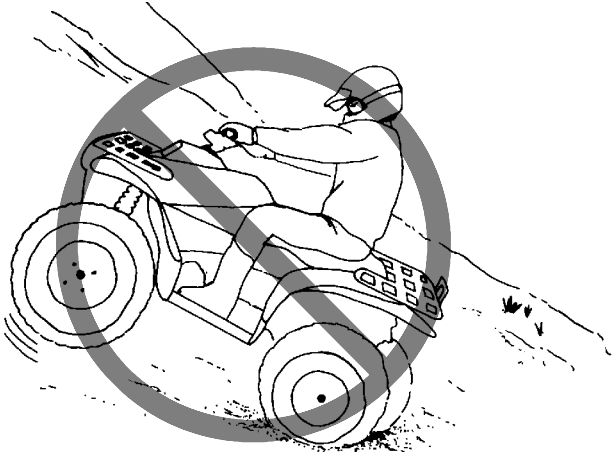

POTENTIAL HAZARD

Climbing hills improperly.

WHAT CAN HAPPEN

Improper hill climbing could cause loss of control or overturn.

HOW TO AVOID THE HAZARD

Always follow proper procedures for climbing hills as described in the owner's manual.

Always check the terrain carefully before ascending any hill.

Never operate the ATV on hills steeper than 25°.

Never climb hills with excessively slippery or loose surfaces.

Shift your weight forward.

Never open the throttle suddenly while traveling uphill. The ATV could flip over backwards.

Never go over the top of any hill at high speed. An obstacle, a sharp drop, or another vehicle or person could be on the other side of the hill.

SAFETY

Operator Safety

⚠ WARNING

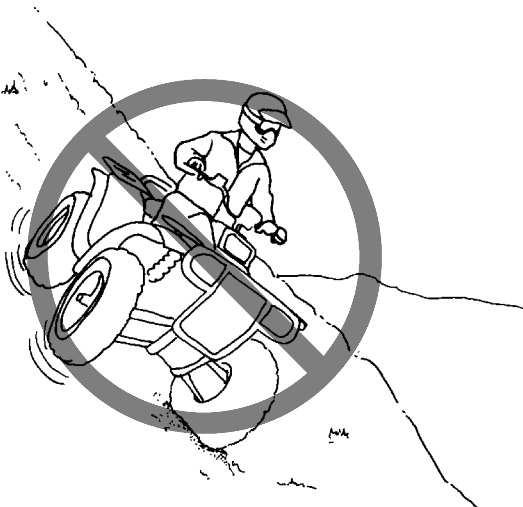

POTENTIAL HAZARD

Traveling downhill improperly.

WHAT CAN HAPPEN

Improperly descending a hill could cause loss of control or overturn.

HOW TO AVOID THE HAZARD

Always follow proper procedures for traveling down hills as described in the owner's manual. **NOTE:** A special technique is required when braking while traveling downhill. See page 62.

Always check the terrain carefully before descending a hill.

Shift your weight backward.

Never travel down a hill at high speed.

Avoid traveling down a hill at an angle, which would cause the vehicle to lean sharply to one side. Travel straight down the hill when possible.

Operator Safety

⚠ WARNING



POTENTIAL HAZARD

Improperly crossing hills and turning on hills.

WHAT CAN HAPPEN

Improperly crossing or turning as hills could cause loss of control or overturn.

HOW TO AVOID THE HAZARD

Never attempt to turn the ATV around on any hill until you've mastered the turning technique (on level ground) as described in the owner's manual. See page 63. Use extra caution when turning on any hill.

Avoid crossing the side of a steep hill.

When crossing the side of a hill:

Always follow proper procedures as described in the owner's manual.

Avoid hills with excessively slippery or loose surfaces.

Shift your weight to the uphill side of the ATV.

SAFETY

Operator Safety

⚠ WARNING

POTENTIAL HAZARD

Stalling, rolling backwards or improperly dismounting while climbing a hill.

WHAT CAN HAPPEN

The vehicle could overturn.

HOW TO AVOID THE HAZARD

Maintain steady speed when climbing a hill.

If all forward speed is lost:

Keep your weight uphill.

Apply the brakes.

Lock the parking brake when fully stopped.

If the ATV begins rolling backwards:

Keep weight uphill.

Never apply engine power.

Never apply the rear brake while rolling backwards.

Apply the single-lever brake gradually.

When fully stopped, apply the rear brake as well, and then lock the parking brake.

Dismount on uphill side, or to either side if ATV is pointed straight uphill.

Turn the ATV around and remount, following the procedure described in the owner's manual. See page 63.



Operator Safety

WARNING

POTENTIAL HAZARD

Improperly operating over obstacles.

WHAT CAN HAPPEN

Operating over obstacles could cause loss of control or overturn.

HOW TO AVOID THE HAZARD

Before operating in a new area, check for obstacles.

Avoid operating over large obstacles such as rocks and fallen trees when possible. If unavoidable, use extreme caution and always follow proper procedures as outlined in the owner's manual.

WARNING

POTENTIAL HAZARD

Skidding or sliding.

WHAT CAN HAPPEN

Skidding or sliding can cause loss of control.

If the tires regain traction unexpectedly, the ATV could overturn.

HOW TO AVOID THE HAZARD

On slippery surfaces such as ice, travel slowly and use extra caution to reduce the chance of skidding or sliding out of control.

SAFETY

Operator Safety

WARNING

POTENTIAL HAZARD

Operating the ATV through deep or fast-flowing water.

WHAT CAN HAPPEN

Tires may float, causing loss of traction and loss of control, which could lead to an accident or overturn.

HOW TO AVOID THE HAZARD

Avoid operating the ATV through deep or fast-flowing water. If it's unavoidable to enter water that exceeds the recommended maximum depth (see page 64), travel slowly, balance your weight carefully, avoid sudden movements, and maintain a slow and steady forward motion. Do not make sudden turns or stops, and do not make sudden throttle changes.

Wet brakes may have reduced stopping ability. Always test the brakes after leaving water. If necessary, apply them several times to let friction dry out the pads.

WARNING

POTENTIAL HAZARD

Improperly operating in reverse.

WHAT CAN HAPPEN

The ATV could collide with an obstacle or person, resulting in severe injury.

HOW TO AVOID THE HAZARD

Before shifting into reverse gear, always check for obstacles or people behind the ATV. When it's safe to proceed, back slowly.

Operator Safety

WARNING

POTENTIAL HAZARD

Operating this ATV with improper tires, or with improper or uneven tire pressure.

WHAT CAN HAPPEN

Use of improper tires, or operation of the ATV with improper or uneven tire pressure, could cause loss of control or accident.

HOW TO AVOID THE HAZARD

Always use the size and type of tires specified for the ATV in the owner's manual.

Always maintain proper tire pressure as described in the owner's manual and on safety decals.

WARNING

POTENTIAL HAZARD

Operating the ATV with improper modifications.

WHAT CAN HAPPEN

Improper installation of accessories or modification of the ATV may cause changes in handling, which could lead to an accident.

HOW TO AVOID THE HAZARD

Never modify the ATV through improper installation or use of accessories. All parts and accessories added to the vehicle must be genuine Polaris Industries Inc. or equivalent components designed for use on this ATV and should be installed and used according to approved instructions. See your authorized Polaris ATV dealer for more information.

SAFETY

Operator Safety

WARNING

POTENTIAL HAZARD

Overloading the ATV or carrying/towing cargo improperly.

WHAT CAN HAPPEN

Overloading and towing can cause changes in vehicle handling, which could lead to loss of control or an accident.

HOW TO AVOID THE HAZARD

Never exceed the stated load capacity for this ATV.

Cargo should be properly distributed and securely attached.

Reduce speed when carrying cargo or pulling a trailer. Allow a greater distance for braking.

Always follow the instructions in the owner's manual for carrying cargo or pulling a trailer.

WARNING

POTENTIAL HAZARD

Operating on frozen bodies of water.

WHAT CAN HAPPEN

Severe injury or death can result if the ATV and/or the operator fall through the ice.

HOW TO AVOID THE HAZARD

Never operate the ATV on a frozen body of water. If you're confident that the ice is thick enough and sound enough to support the machine and its operator, as well as the force created by a moving vehicle, exercise extreme caution.

Operator Safety

WARNING

Operating a damaged ATV can result in an accident with serious injury or death. After any overturn or accident, have a qualified service dealer inspect the entire machine for possible damage, including (but not limited to) brakes, throttle and steering systems.

WARNING

Safe operation of this rider-active vehicle requires good judgement and physical skills. Persons with cognitive or physical disabilities who operate this vehicle have an increased risk of overturn and loss of control, which could result in severe injury or death.

CAUTION

Exhaust system components are very hot during and after use of the vehicle. Hot components can cause serious burns and fire. Do not touch hot exhaust system components. Always keep combustible materials away from the exhaust system. Use caution when traveling through tall grass, especially dry grass.

CONTROLS

Engine Electrical Switches

⚠️ WARNING

Activating the override switch while the throttle is open can cause loss of control, resulting in severe injury or death. Do not activate the override switch while the throttle is open.

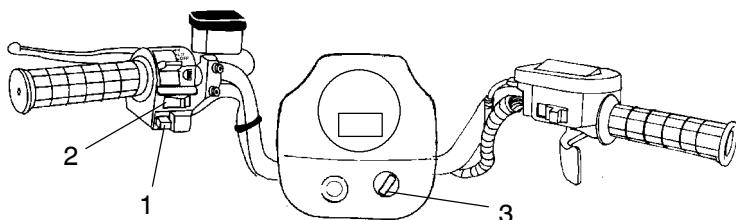

Mode/Reverse Override Switch (1) - This vehicle is equipped with a reverse speed limiter system. To gain additional power while backing, depress the override switch. **NOTE:** The override switch also allows activation of AWD in reverse, if the AWD switch is on. This switch is also used to toggle through the different modes of the rider information center. See page 45.

Engine Stop Switch (2) - The engine will not start or run when the switch is in the *OFF* position. Its purpose is to provide the operator with a quick means of engine shutdown in case of an emergency.

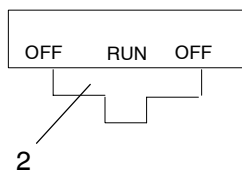

Main Switch (3) - To start the engine, slide the stop switch to the center *RUN* position and turn the main key switch clockwise past the *ON* position. Release the key when the engine starts.

NOTE: Both the main switch and the emergency engine stop switch will shut off all electrical power to the vehicle, including lights. To stop the engine, slide the stop switch either right or left to the *OFF* position.

⚠️WARNING

Operating an ATV with sticking or improperly operating throttle controls could cause an accident and lead to severe injury or death.

Never start or operate an ATV with a sticking or improperly operating throttle. Always contact your dealer for service if throttle problems arise.

Failure to check or maintain proper operation of the throttle system can result in an accident if the throttle lever sticks during operation. Always check the lever for free movement and return before starting the engine. Also check occasionally during operation.

Throttle Lever

Engine speed and vehicle movement are controlled by pressing the throttle lever (1). The throttle lever is spring loaded. Engine speed returns to idle when the lever is released.

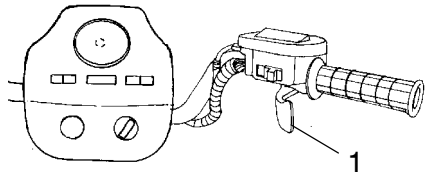

This ATV is equipped with Polaris Electronic Throttle Control (ETC), which is designed to reduce the risk of a frozen or stuck throttle. If the throttle cable should stick in an open position when the operator releases the throttle lever, the engine will stop, and power to the rear wheels will cease.

⚠️WARNING

The Electronic Throttle Control (ETC) stops the engine in the event of a throttle system malfunction and is provided for your safety. Do not attempt to modify the ETC system or replace it with any after market throttle mechanisms.

CONTROLS

Light Switches

The light switch is located on the left handlebar. It's used to turn the lights on and off and to switch the lights from HI to LO. **NOTE:** The lights won't work unless the key is in the *ON* position and the shut-off switch is in the *RUN* position.

⚠WARNING

Operating the ATV on streets or roads, especially in darkness, could result in an accident and serious injury or death.

Your ATV is not equipped with highway-approved lights. It's designed for and must be used for *off-road use only*. Use caution and drive at reduced speeds in conditions of reduced visibility such as fog, rain and darkness.

Brake Lever

The front and rear brakes are applied by squeezing the brake lever (1) toward the handlebar. The front and rear brakes are hydraulically activated disc type brakes that are activated by only one lever.

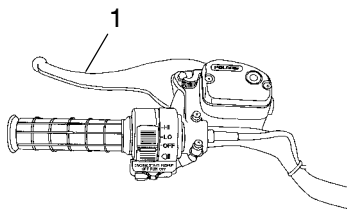

Always test brake lever travel and master cylinder fluid level before riding.

When squeezed, the lever should feel firm. Any sponginess would indicate a possible fluid leak or low master cylinder fluid level, which must be corrected before riding. Contact your dealer for proper diagnosis and repairs.

⚠WARNING

Operating the ATV with a spongy brake lever can result in loss of braking, which could cause an accident.

Never operate the ATV with a spongy-feeling brake lever.

Master Cylinder

The brake fluid in the master cylinder (1), which is located on the left handlebar, should be checked before each ride. The fluid level can be seen through an indicator window (2) on the top of the master cylinder. This eye will appear dark when the fluid level is full. When fluid needs to be added, the eye will be clear.

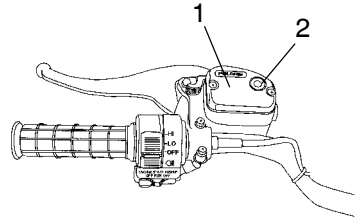

NOTE: When checking the fluid level, the ATV must be on level ground with the handlebars straight. If the fluid level is low add DOT 3 brake fluid only. See page 115 for the part numbers of Polaris products.

WARNING

After opening a bottle of brake fluid, always discard any unused portion. Never store or use a partial bottle. Brake fluid is hygroscopic, meaning it rapidly absorbs moisture from the air. The moisture causes the boiling temperature of the brake fluid to drop, which can lead to early brake fade and the possibility of accident or severe injury.

CONTROLS

Parking Brake

⚠️ WARNING

Operating the ATV while the parking brake is engaged could result in an accident and serious injury or death. Always check to be sure the parking brake is disengaged before operating.

Setting the Parking Brake

1. Place the transmission in PARK.
2. Squeeze and release the brake lever (1) two or three times, then squeeze and hold.
3. Push the park brake lock (2) forward to engage the brake. Release the brake lever.
4. To release the parking brake lock, squeeze and release the brake lever. It will return to its unlocked position.

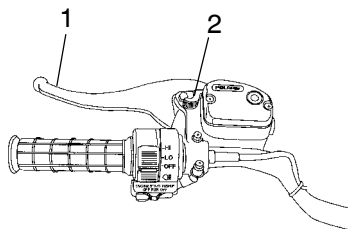

Important Safeguards

- The parking brake may relax if left on for a long period of time. Always block the wheels to prevent rolling.
- Always block the wheels on the downhill side of the ATV if leaving it parked on a hill. Another option is to park the ATV in a sidehill position.
- Never depend on the parking brake alone if the ATV is parked on a hill. Always block the wheels to prevent rolling.

Auxiliary Brake

⚠ WARNING

Aggressively applying the auxiliary brake when backing down a hill may cause rear tipover, which could result in serious injury or death.

Use caution when applying the auxiliary brake. Do not aggressively apply the auxiliary brake when going forward. The rear wheels may skid and slide sideways, causing loss of control and serious injury or death.

Your Polaris ATV has an auxiliary brake (1) for added safety. It's located on the inside of the right floor board and is operated by the right foot. The auxiliary brake serves as a backup to the main brake system if the main system becomes inoperative.

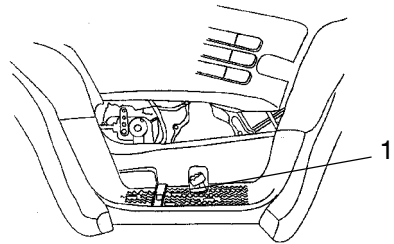

If the rear wheels slide while using the auxiliary brake, *reduce* brake pedal pressure to brake the rear wheels without skidding.

Brake Fluid Level

Check the brake fluid level frequently for the auxiliary brake system. The reservoir is located under the seat or near the auxiliary brake. Maintain the fluid level between the maximum and minimum marks.

CONTROLS

Choke

The choke assists in starting a cold engine. Refer to the engine starting procedure on page 53 for correct choke and throttle settings during starting.

Fuel Valve

The fuel valve (1) is located on the left side panel. It has two positions:

OFF: For vehicle storage and when transporting.

ON: For normal operation.

Fuel Tank

The fuel tank filler cap (2) is located directly below the handlebar. Use either leaded or unleaded gasoline with a minimum pump octane number of $87 = (R + M/2)$ octane.

Fuel Filter

The in-line fuel filter should be replaced by your dealer after every 100 hours of operation, or annually. Do not attempt to clean the fuel filter.

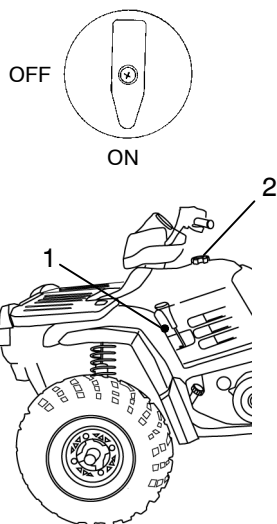

CONTROLS

Automatic Transmission Gear Selector

The transmission gear selector (1) is located on the right side of the vehicle. Shift patterns vary, depending on your model.

H: High Gear

L: Low Gear

N: Neutral

R: Reverse

P: Park

To shift into HIGH or PARK, you must first apply the auxiliary brake to activate the high/park lock-out mechanism. When shifting out of HIGH or PARK, it's not necessary to apply the brake.

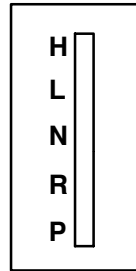
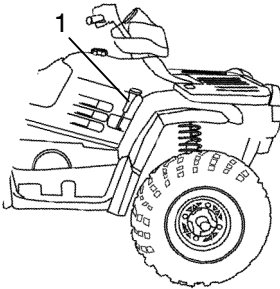

CAUTION

Shifting gears with the engine speed above idle or while the vehicle is moving could cause transmission damage.

To change gears, stop the vehicle, and with the engine idling, move the lever to the desired gear. Apply the auxiliary brake if shifting into HIGH or PARK.

Whenever the ATV is left unattended, always place the transmission in PARK and lock the parking brake.

Belt Life

To extend belt life, use low forward gear in heavy pulling situations and when operating at less than seven miles per hour for extended periods of time.

FEATURES

All Wheel Drive (AWD) System

Polaris 4-wheel drive ATVs are equipped with a unique, Polaris-exclusive, All Wheel Drive (AWD) system, which is activated by a switch (1) on the right handlebar. When the switch is off, the ATV is in 2 wheel drive at all times. When the switch is on, the ATV is in AWD and the AWD indicator light in the instrument cluster will be on.

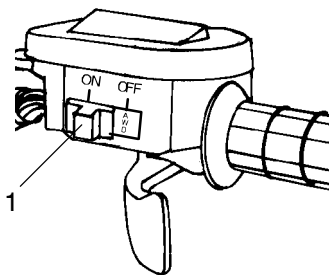

When in AWD, the front gearcase will automatically engage any time the rear wheels lose traction. When the rear wheels regain traction, the front gearcase will automatically disengage.

NOTE: The override switch allows activation of AWD in reverse if the AWD switch is on. See page 36.

There is no limit to the length of time the vehicle may remain in AWD.

Engaging Front Gearcase

The AWD switch may be turned on or off while the vehicle is moving. Initially, the vehicle's electronic system will not enable the AWD until the engine RPM is below 3100. Once enabled, the AWD remains enabled until the AWD switch is turned off. If the switch is turned off while the front gearcase is moving, it will not disengage until the rear wheels regain traction.

Engage the AWD switch before getting into conditions where front wheel drive may be needed. If the rear wheels are spinning, release the throttle before switching to AWD.

CAUTION

Switching to AWD while the rear wheels are spinning may cause severe drive shaft and gearcase damage. Always switch to AWD while the rear wheels have traction or are at rest.

Instrument Cluster

Your ATV is equipped with an instrument cluster that senses vehicle speed from the right front wheel. The instrument cluster measures distance in miles or kilometers as well as hours of operation. It also includes a reverse speed limiter function that limits the ATV's speed to approximately 7-9 mph. Refer to page 36 for additional information.

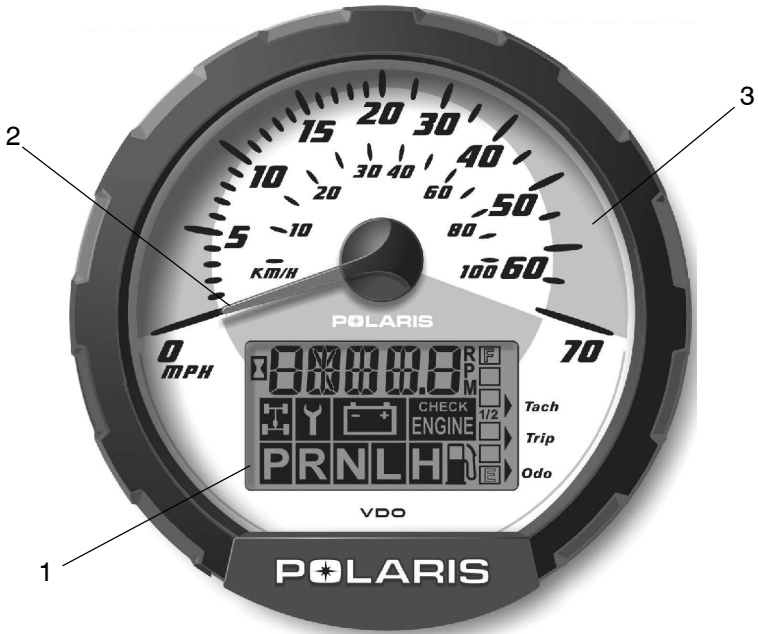

1. Rider Information Center
2. Speedometer needle - in addition to showing vehicle speed, the needle flashes when a warning condition exists.
3. Speedometer

CAUTION

To prevent damage, wash the ATV by hand or with a garden hose using mild soap. Do not use alcohol to clean the instrument cluster. Immediately clean off any gasoline that splashes on the instrument cluster. Do not allow insect sprays to come into contact with the lens.

FEATURES

Instrument Cluster

Rider Information Center

The rider information center is located in the instrument cluster. All segments will light up for 2.5 seconds at start-up.

NOTE: If the instrument cluster fails to illuminate, a battery over-voltage may have occurred and the instrument cluster may have shut off to protect the cluster's electrical system. If this occurs, take the ATV to your Polaris dealer for proper diagnosis.

1. **Gear Indicator** - As the shift lever is moved, this indicates the gear the transmission is in:

H = High Range

L = Low Range

N = Neutral

R = Reverse

P = Park

2. **AWD Indicator** - This indicator illuminates when the electrical portion of the AWD system is enabled.

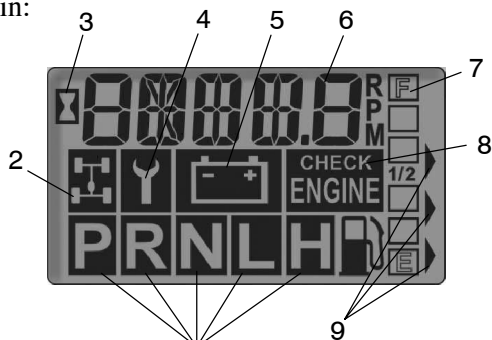

3. **Engine Hour Display Indicator**
4. **Service Interval/Diagnostic Mode Indicator**
5. **Low Battery and Over Voltage** - This warning usually indicates that the ATV is being operated at an RPM too low to keep the battery charged. A low battery warning may also occur under normal operation if the machine is at idle and high electrical load (lights, cooling fan, accessories) is applied. Driving at a higher RPM or connecting a battery charger will usually clear the warning.
6. **Odometer/Tachometer/Tripmeter/ Hour Meter**
7. **Fuel Gauge** - The segments of the fuel gauge show the level of fuel in the fuel tank. When the last segment clears, a low fuel warning is activated. All segments will flash, "FUEL" will display in the LCD, and the speedometer needle will blink. Refuel immediately.
8. **Check Engine Warning Indicator** - The word HOT will display alphanumerically when the engine is overheating. Do not continue to operate the ATV if this warning appears or serious engine damage could result.
9. **Mode Indicator**

Instrument Cluster

Rider Information Center

The rider information center has 4 standard modes:

Mode 1 - Odometer

Mode 2 - Tripmeter

Mode 3 - Total Service Hours

Mode 4 - Tachometer

The reverse override button on the left handlebar is also the *mode button*. **NOTE:** If using the mode button to program the rider information center, or to toggle through the options, the machine cannot be in reverse.

Mode 1 - Odometer

The odometer records the miles traveled by the ATV.

Mode 2 -Trip Meter

The trip meter records the miles traveled by the ATV on each trip if it's reset before each trip. To reset the trip meter, select the trip meter mode. Press and hold the mode button (override button) until the total changes to 0. **NOTE:** In the Rider Information Center, the trip meter display contains a decimal point, but the odometer displays without a decimal point.

Mode 3 - Hour Meter

This mode logs the total hours the engine has been in operation.

Mode 4 - Tachometer

The engine RPM is displayed digitally. **NOTE:** Small fluctuations in the RPM from day to day may be normal because of changes in humidity, temperature, elevation and electrical loads.

FEATURES

Instrument Cluster

Rider Information Center

Diagnostic Mode

The diagnostic mode is for informational purposes only. Please return your ATV to your dealer for all major repairs.

As long as the gauge is in the diagnostic mode, the wrench icon will remain lit.

To leave the diagnostic mode, either shift the machine out of neutral or turn the key switch off and on. **NOTE:** Any movement of the tires will also take the machine out of the diagnostic mode.

To enter the diagnostics mode:

1. Turn the key switch off and wait 10 seconds.
2. Set the park brake and shift the transmission to neutral.
3. Hold the mode/reverse override button and turn the key switch on.
4. Release the switch as soon as the display is activated.

The initial screen display refers to the software version installed in your ATV. This information is displayed briefly.

Use the mode/reverse override button to toggle through the diagnostic screens.

Screen 1: Battery voltage

Screen 2: Tachometer

Screen 3: AWD diagnostic

This gauge indicates whether or not current is flowing through the AWD coil (only on models with switchable AWD).

Screen 4: Gear circuit diagnostic

This screen displays the resistance value (in ohms) being read at the gear switch input of the gauge.

Instrument Cluster

Rider Information Center

Diagnostic Mode

Screen 5: Programmable service interval

The purpose of the programmable service interval is to provide the consumer and dealer with a convenient reminder for routine maintenance. When your vehicle leaves the factory, this feature is set at 50 hours. You must enable the programmable service interval before it can be used.

Once the service interval mode is set with the hours when service is due, the hours of actual engine operation are subtracted from the set hours until 0 is reached. When the counter reaches 0, the wrench icon will flash quickly for 5 seconds each time the vehicle is started as a reminder that the periodic maintenance is due.

To set the hours, press and hold the mode/override button until the wrench icon flashes. When it begins to flash, release the button. The setting will increase by one hour each time the button is pressed. Pressing and holding the button will allow the numbers to escalate much faster. When the desired time increment is displayed, release the button and wait for the wrench to stop flashing. When the wrench stops blinking, your service hours are set. **NOTE:** If you scroll past the intended number, hold the button down until the count turns over to 0. You can then reset the number.

If the service interval is enabled on your ATV and you wish to turn it off, toggle to the service interval mode. Press and hold the mode button for approximately 7 seconds until the word *OFF* appears in the Rider Information Center.

Screen 6: Miles/Kilometers toggle

The display in the tripmeter and odometer can be changed to display either kilometers or miles. The current display mode will be shown as KM or MP. To change, hold in the mode button until the letters flash, then press and release the button once. When the display stops flashing, the mode has been set.

OPERATION

Fuel Safety

WARNING

Gasoline is highly flammable and explosive under certain conditions.

- Always exercise extreme caution whenever handling gasoline.
- Always refuel with the engine stopped, and outdoors or in a well ventilated area.
- Do not smoke or allow open flames or sparks in or near the area where refueling is performed or where gasoline is stored.
- Do not overfill the tank. Do not fill the tank neck.
- If gasoline spills on your skin or clothing, immediately wash it off with soap and water and change clothing.
- Never start the engine or let it run in an enclosed area. Engine exhaust fumes are poisonous and can cause loss of consciousness or death in a short time.
- Turn the fuel valve off whenever the ATV is stored or parked.

WARNING

The engine exhaust from this product contains chemicals known to cause cancer, birth defects or other reproductive harm.

Operate this vehicle only outdoors or in well-ventilated areas.

Break-In Period

The break-in period for your new Polaris ATV is defined as the first ten hours of operation, or the time it takes to use the first two full tanks of gasoline. No single action on your part is as important as following the procedures for a proper break-in. Careful treatment of a new engine will result in more efficient performance and longer life for the engine. Perform the following procedures carefully.

CAUTION

Excessive heat build-up during the first three hours of operation will damage close-fitted engine parts. Do not operate at full throttle or high speeds for extended periods during the first three hours of use.

CAUTION

Mixing brands or using a non-recommended oil may cause serious engine damage. We recommend the use of Polaris Premium 4 synthetic Oil or another 0W-40 API certified *SH* oil. Never substitute or mix oil brands.

1. Fill the fuel tank with gasoline. See page 42.
2. Check the oil reservoir level on the dipstick. See page 77. Add oil if necessary to maintain the level between the safe and add marks.
3. Drive slowly at first. Select an open area that allows room to familiarize yourself with vehicle operation and handling.
4. Vary the throttle positions. Do not operate at sustained idle.
5. Perform regular checks on fluid levels, controls and areas outlined on the daily pre-ride inspection checklist. See page 52.
6. Pull only light loads.
7. During the break-in period, change both the oil and the filter at 20 hours or 200 miles.

OPERATION

Pre-Ride Inspection

WARNING

If a proper inspection is not done before each use, severe injury or death could result. Always inspect the vehicle before each use to ensure it's in proper operating condition.

Use the following checklist to verify that your vehicle is in proper working condition before each use.

Item/Inspection Procedure

1. Tires - Check condition and pressures.
2. Fuel tank and engine oil level - Fill both to their proper levels.
3. All brakes - Check operation, adjustment and fluid levels (includes auxiliary brake).
4. Throttle - Check for free operation and closing.
5. Headlight/Taillight/Brakelight - Check operation of all indicator lights and switches.
6. Engine stop switch - Check for proper function.
7. Wheels - Check for tightness of wheel nuts and axle nuts; check that axle nuts are secured by cotter pins.
8. Air cleaner element - Check for dirt; clean or replace.
9. Steering - Check for free operation, noting any unusual looseness in any area.
10. Loose parts - Visually inspect the vehicle for any damaged components or loose nuts/bolts or fasteners.
11. Riding gear - Wear a helmet, goggles and protective clothing.
12. Engine coolant - Check for proper level at the recovery bottle.

Starting the Engine

Starting a Cold Engine

⚠ WARNING

Engine exhaust contains poisonous carbon monoxide and can cause loss of consciousness resulting in severe injury or death. Never run an engine in an enclosed area.

1. Place the transmission in PARK and lock the parking brake.
2. Turn the fuel tank valve on.
3. Sit on the vehicle and pull the choke knob out until it stops (1).

NOTE: The variable choke is fully on when the knob is pulled completely out. The choke is off when the knob is pushed completely in. The choke can be adjusted gradually, depending on how much choke is needed for starting. Be sure the choke is off during operation, as excess fuel washing into the engine oil will increase wear on engine components.

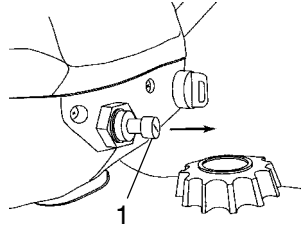

4. Turn the engine stop switch to *RUN*.

NOTE: Do not press the throttle while starting the engine.

5. Turn the ignition key past the *ON* position to engage the starter. Activate the starter for a maximum of five seconds, releasing the key when the vehicle starts. If the engine does not start, release the starter and wait five seconds. Activate the starter for another five seconds if necessary. Repeat this procedure until the engine starts.
6. If the engine slows or stops, position the choke knob half way in to allow proper engine warm-up.
7. Vary the engine RPM slightly with the throttle to aid in warm-up. When the engine idles smoothly, push the choke completely in.

CAUTION

Operating the vehicle immediately after starting could cause engine damage. Allow the engine to warm up for several minutes before operating the vehicle.

OPERATION

Starting the Engine

Starting a Warm Engine

Warm engines do not normally require the use of the choke. Using the choke can cause the spark plug to become wet fouled.

1. Position the vehicle on a level surface with the transmission in PARK.
2. Lock the parking brake, turn the fuel tank valve on, sit on the vehicle, and turn the engine stop switch to *RUN*.
3. If the engine has cooled to a point where it does not readily start, intermittent use of the choke (knob pulled half way out) may be necessary.
4. If the engine is over-choked when warm, depress the throttle lever fully while cranking to aid in starting.
5. Release the throttle lever *immediately* after the engine starts. If the engine does not start and all conditions are favorable, change the spark plug and try again.

Cold Weather Operation

If the ATV is used year-round, check the oil level frequently. A rising oil level could indicate the accumulation of contaminants such as water or excess fuel in the bottom of the oil tank. Water in the bottom of the tank can lead to engine damage and must be drained. Water accumulation increases as outside temperature decreases.

See your Polaris dealer for engine heater kits, which provide quicker warm-ups and easier starting in colder weather.

Hauling Cargo

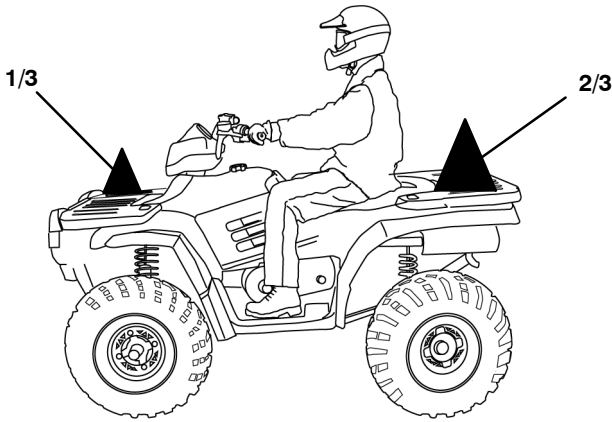

Your ATV has been designed to carry or tow a certain amount of load. Always read and understand the load distribution warning labels on the vehicle, and never exceed the weight capacities outlined in the specifications section of the owner's manual and on the safety decals.

Cargo weight should be evenly distributed ($\frac{1}{3}$ on the front rack and $\frac{2}{3}$ on the rear rack) and mounted as low as possible. When operating over rough or hilly terrain, reduce speed and cargo weight to maintain stable driving conditions. Do not obstruct the headlight beam with cargo.

Belt Life

Use low forward gear when hauling or towing heavy cargo to extend belt life.

OPERATION

Hauling Cargo

WARNING

Hauling cargo improperly can alter vehicle handling and may cause loss of control or brake instability and result in serious injury or death. Always follow these precautions when hauling cargo:

- **REDUCE SPEED AND ALLOW GREATER DISTANCES FOR BRAKING WHEN HAULING CARGO.**
- **CARGO WEIGHT DISTRIBUTION** should be 1/3 on the front rack and 2/3 on the rear rack. When operating over rough or hilly terrain, reduce speed and cargo to maintain stable driving conditions. Carrying loads on one rack only increases the possibility of vehicle overturn.
- **CARRY LOADS AS LOW ON THE RACKS AS POSSIBLE.** Carrying loads high on the racks raises the center of gravity of the vehicle and creates a less stable operating condition.
- **SECURE ALL LOADS BEFORE OPERATING.** Unsecured loads can create unstable operating conditions, which could result in loss of control of the vehicle.
- **OPERATE ONLY WITH STABLE AND SAFELY ARRANGED LOADS.** When handling off-centered loads that cannot be centered, securely fasten the load and operate with extra caution. Always attach the tow load to the hitch point designated for your vehicle.
- **HEAVY LOADS CAN CAUSE BRAKING AND CONTROL PROBLEMS.** Use extreme caution when applying brakes with a loaded vehicle. Avoid terrain or situations that may require backing downhill.
- **USE EXTREME CAUTION** when operating with loads that extend over the rack sides. Stability and maneuverability may be adversely affected, causing the vehicle to overturn.
- **DO NOT BLOCK THE FRONT HEADLIGHT BEAM** when carrying loads on the front rack.
- **DO NOT TRAVEL FASTER THAN THE RECOMMENDED SPEEDS.** Vehicle should never exceed 10 mph (16 kph) while towing a load on a level grass surface. Vehicle speed should never exceed 5 mph (8 kph) when towing loads in rough terrain, while cornering, or while ascending or descending a hill.

Driving Safely Driving Procedures



1. Sit upright with both feet on the footrests and both hands on the handlebars.
2. Start the engine and allow it to warm up, then shift the transmission into gear.
3. Check your surroundings and determine your path of travel.
4. Release the parking brake.
5. Slowly depress the throttle with your right thumb and begin driving. Vehicle speed is controlled by the amount of throttle opening.
6. Drive slowly. Practice maneuvering and using the throttle and brakes on level surfaces.

OPERATION

Driving Safely

Making Turns

Your ATV is equipped with a solid rear axle, which drives both rear wheels equally at all times. This means that the wheel on the outside of the turn must travel a greater distance than the inside wheel when turning and the inside tire must slip traction slightly. To turn, steer in the direction of the turn, leaning your upper body to the inside of the turn while supporting your weight on the outer footrest. This technique alters the balance of traction between the rear wheels, allowing the turn to be made smoothly. The same leaning technique should be used for turning in reverse.



NOTE: Practice making turns at slow speeds before attempting to turn at faster speeds.

⚠️ WARNING

Turning at sharp angles or at excessive speeds can result in vehicle overturn and lead to serious injury. Avoid turning at sharp angles. Never turn at high speeds.

Driving Safely

Driving on Slippery Surfaces

Whenever riding on slippery surfaces such as wet trails or loose gravel, or during freezing weather, follow these precautions:

1. Slow down when entering slippery areas.
2. Engage AWD before wheels begin to lose traction.
3. Maintain a high level of alertness, reading the trail and avoiding quick, sharp turns, which can cause skids.
4. Correct a skid by turning the handlebars in the direction of the skid and shifting your body weight forward.



CAUTION

Severe damage to drive train may occur if the AWD is engaged while the wheels are spinning. Always allow the rear wheels to stop spinning before engaging AWD, or engage AWD before wheels begin to lose traction.

⚠️ WARNING

Failure to exercise care when operating on slippery surfaces can result in loss of tire traction and cause loss of control, accident, and serious injury or death.

Never apply the brakes during a skid. Do not operate on excessively slippery surfaces. Always reduce speed and use additional caution.

OPERATION

Driving Safely

Traveling Uphill

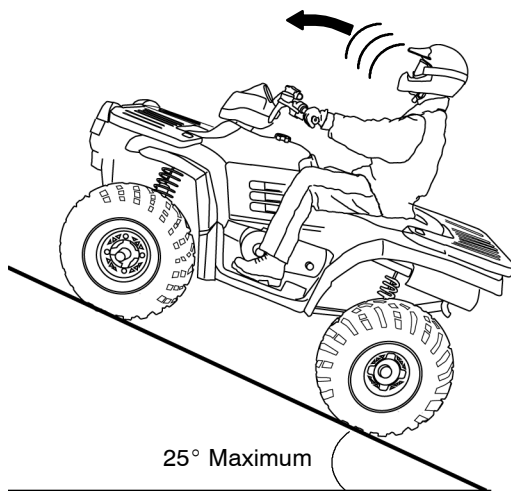

Whenever traveling uphill, follow these precautions:

1. Always travel straight uphill.
2. Avoid steep hills (25° maximum).
3. Keep both feet on the footrests.
4. Transfer your weight forward.
5. Proceed at a steady rate of speed and throttle opening.
6. Remain alert and be prepared to take emergency action. This may include quick dismounting of the vehicle.

⚠️ WARNING

Braking and handling are greatly affected when operating in hilly terrain. Improper procedure could cause loss of control or overturn and result in serious injury or death.

Avoid climbing steep hills (25° maximum).

Use extreme caution when operating on hills, and follow proper operating procedures outlined in the owner's manual.

Driving Safely Sidehilling



⚠️ WARNING

Improperly crossing hills or turning on hills can result in loss of control or vehicle overturn, resulting in severe injury or death. Avoid crossing the side of a hill when possible. Follow proper procedures as outlined in the owner's manual.

Sidehilling can be the most dangerous type of driving encountered and should be avoided if at all possible. If you do enter into a situation where sidehilling is necessary, follow these precautions:

1. Slow down.
2. Lean into the hill, transferring your upper body weight toward the hill while keeping your feet on the footrests.
3. Steer slightly into the hill to maintain vehicle directions.

NOTE: If the vehicle begins to tip, quickly turn the front wheel downhill, if possible, or dismount on the uphill side *immediately!*

OPERATION

Driving Safely

Traveling Downhill



Whenever descending a hill, follow these precautions:

1. Proceed directly downhill.
2. Transfer your weight to the rear of the vehicle.
3. Slow down.
4. Apply the brakes *slightly* to aid in slowing.

Familiarize yourself with operation of the auxiliary brake in the event loss of normal service brakes occurs.

▲WARNING

Excessive speed can cause loss of control and lead to serious injury or death. Always operate slowly when traveling downhill.

Driving Safely

Turning Around on a Hill

⚠️ WARNING

Improper hill climbing procedures could cause loss of control or overturn and result in serious injury or death.

Avoid climbing steep hills (25° maximum).

Use extreme caution when operating on hills, and follow proper operating procedures outlined in the owner's manual.

If the vehicle stalls while climbing a hill, never back it down the hill! One maneuver that can be used when you must turn around while climbing a hill is the K-turn:

1. Stop and lock the parking brake while keeping body weight uphill.
2. Leave the transmission in forward and shut off the engine.
3. Dismount on the uphill side of the vehicle, or on the left if the vehicle is pointing straight uphill.
4. Staying uphill of the vehicle, turn the handlebars full left.
5. While holding the service brake, release the parking brake lock and slowly allow the vehicle to roll around to your right until it's pointing across the hill or slightly downward.
6. Lock the parking brake and remount the vehicle from the uphill side, keeping body weight uphill.
7. Restart the engine with the transmission still in forward.
8. Release the parking brake and proceed *slowly*, controlling speed with the service brake, until the vehicle is on more level ground.

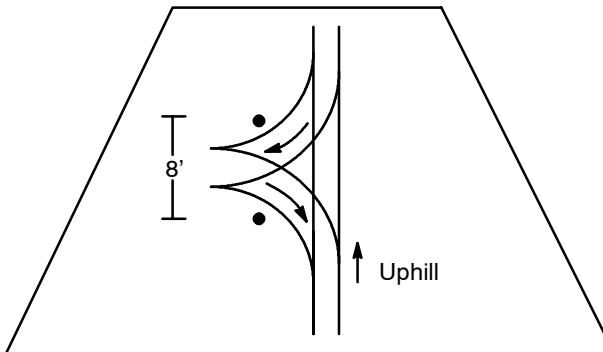

OPERATION

Driving Safely

Driving Through Water

Your ATV can operate through water with a maximum recommended depth equal to the bottom of the footrests (1). Follow these procedures when operating through water:



1. Determine water depths and current before crossing.
2. Choose a crossing where both banks have gradual inclines.
3. Proceed slowly, avoiding rocks and obstacles if possible.
4. After crossing, dry the brakes by applying light pressure to the lever until braking action is normal.

After running the vehicle in water, it's *critical* to have it serviced as outlined in the maintenance chart. See page 69. The following areas need special attention: engine oil, transmission oil, front and rear gearcases, and all grease fittings.

⚠ CAUTION

Major engine damage can result if the vehicle is not thoroughly inspected after operation in water. Perform the services outlined in the maintenance chart.

If your vehicle becomes immersed or is operated in water that exceeds the footrest level, take it to your dealer for service before starting the engine.

NOTE: Avoid operating the vehicle through deep or fast-flowing water. If you cannot avoid water that exceeds the recommended maximum depth, go slowly, balance your weight carefully, avoid sudden movements, and maintain a slow and steady forward motion. Do not make sudden turns or stops, and do not make sudden throttle changes.

If your vehicle becomes immersed, and it's impossible to take it to a dealer before starting it, follow the steps described on page 99. Have the vehicle serviced by your dealer at the first opportunity.

Driving Safely

Driving Over Obstacles



Be alert! Look ahead and learn to read the terrain you're traveling on. Be constantly alert for hazards such as logs, rocks and low hanging branches.

⚠️ WARNING

Severe injury or death can result if your vehicle comes in contact with a hidden obstacle. Not all obstacles are immediately visible. Travel with caution in unfamiliar terrain.

OPERATION

Driving Safely

Driving in Reverse

Follow these precautions when operating in reverse:

1. Always avoid backing downhill.
2. Back slowly.
3. When in reverse, apply the brakes *lightly* for stopping.
4. Avoid turning at sharp angles in reverse.
5. Never open the throttle suddenly while backing.



⚠️ WARNING

Failure to use caution when operating in reverse can result in serious injury or death. Before shifting into reverse, always check for obstacles or people behind the vehicle. When it's safe to proceed, back slowly.

Do not use the override switch unless additional power is required for vehicle movement. Use with caution.

Avoid backing on inclines, and avoid turning at sharp angles.

NOTE: Your Polaris ATV is equipped with a reverse speed limiter. The override button should be used with caution as rearward vehicle speed is greatly increased. Do not operate at wide open throttle. Open the throttle just enough to maintain a desired speed.

CAUTION

Excessive throttle operation while in the speed limit mode may cause fuel to build in the exhaust, resulting in engine popping and/or engine damage.

Driving Safely

Parking on an Incline

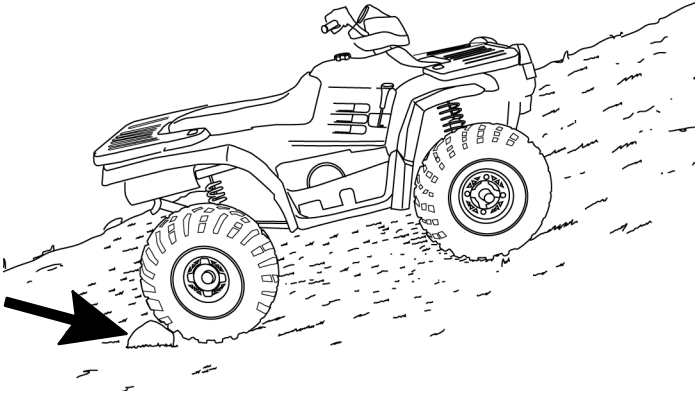

Avoid parking on an incline if possible. If it's unavoidable, follow these precautions:

1. Turn the engine off.
2. Place the transmission in **PARK**.
3. Set the parking brake.
4. Always block the rear wheels on the downhill side as shown in the illustration.
5. Shut off the fuel supply.

EMISSION CONTROL SYSTEMS

Noise Emission Control System

Do not modify the engine, intake or exhaust components, as doing so may affect compliance with state and local noise level requirements.

Spark Arrestor

Your Polaris ATV has a spark arrestor that was tested and approved in accordance with the USDA Forestry Service Standard 5100-1C.

Exhaust Emission Control System

The exhaust emission control system is composed of efficient carburetor settings with an optimum ignition system. Idle speed can be adjusted with the throttle stop screw. The carburetor must be maintained at Polaris specifications to achieve optimal performance.

Crankcase Emission Control System

This engine is equipped with a closed crankcase system. Blow-by gases are forced back to the combustion chamber by the intake system. The system does not allow the blow-by gases to enter the atmosphere.

MAINTENANCE AND LUBRICATION

Periodic Maintenance Schedule

Careful periodic maintenance will help keep your vehicle in the safest, most reliable condition. Inspection, adjustment and lubrication of important components are explained in the periodic maintenance schedule. Use the instrument cluster's programmable service interval mode to help determine when maintenance service is due. See page 49 for instructions.

Maintenance intervals are based upon average riding conditions and an average vehicle speed of approximately 10 miles per hour. Vehicles subjected to severe use, such as operation in wet or dusty areas, should be inspected and serviced more frequently.

Inspect, clean, lubricate, adjust and replace parts as necessary. When inspection reveals the need for replacement parts, use genuine Polaris parts available from your Polaris dealer.

NOTE: Service and adjustments are critical. If you're not familiar with safe service and adjustment procedures, have a qualified dealer perform these operations.

Maintenance Chart Key

- ▶ Perform these operations more often under severe use, such as in dirty or wet conditions, to purge water or dirt contamination from grease fittings and other critical components.
- ★ Emission Control System Service (California - 4-Cycle)
- Dealer service item.

MAINTENANCE AND LUBRICATION

Periodic Maintenance Schedule

Hours of operation are based on a 10 mph average. If service is due at 20 hours, the equivalent odometer reading would be 200 miles.

Perform all services at whichever reading is reached first.

WARNING

Improperly performing the procedures marked with a ■ could result in component failure and lead to serious injury or death. Have an authorized Polaris dealer perform these services.

	Item	Hours/ Miles	Frequency	Remarks
	Brake System	Pre-Ride	Pre-Ride	Inspect
	Auxiliary Brake	Pre-Ride	Pre-Ride	Inspect
	Tires	Pre-Ride	Pre-Ride	Inspect
	Wheels	Pre-Ride	Pre-Ride	Inspect
	Frame nuts, bolts, fasteners	Pre-Ride	Pre-Ride	Inspect
▶ ★	Air filter,Pre-cleaner	Pre-Ride	Pre-Ride	Inspect; clean
	Coolant level	Pre-Ride	Pre-Ride	Replace coolant every two years
	Fuel tank and engine oil	Pre-Ride	Pre-Ride	Fill to proper levels
	Throttle	Pre-Ride	Pre-Ride	Check operation
	Lights	Pre-Ride	Pre-Ride	Check operation
	Engine stop switch	Pre-Ride	Pre-Ride	Check operation
	Steering	Pre-Ride	Pre-Ride	Check for free operation
▶	Air box sediment tube	Pre-Ride	Pre-Ride	Drain deposits whenever visible
	Headlamp	Pre-Ride	Pre-Ride	Check operation daily; apply Polaris dielectric grease to connector when replaced
	Tail lamp/brake lamp	Pre-Ride	Pre-Ride	Check operation daily; apply Polaris dielectric grease to socket when replaced

▶ More often under severe use, such as dirty or wet conditions

★ Emission Control System Service (California)

■ Dealer service item

MAINTENANCE AND LUBRICATION

Periodic Maintenance Schedule

	Item	Hours/ Miles	Frequency	Remarks
▶ ★	Air filter, main element	Weekly	Weekly	Inspect; replace as needed
▶	Transmission oil level	20 hrs	Monthly	Inspect monthly; change annually
	Battery	20 hrs	Monthly	Check terminals; clean; check fluid level if applica- ble
▶ ★	Engine breather filter	20 hrs	Monthly	Inspect; replace annually and as needed
■	Brake pad wear	10 hrs	Monthly	Inspect periodically
▶	Front and rear gearcase oil	100 hrs	Monthly	Check monthly; change annually
▶	General lubrication	50 hrs	3 months	Lubricate all fittings, pivots, cables, etc.
▶ ★	Engine oil level/oil change	100 hrs / 1000 miles	6 months	Check level daily; break-in service at one month; change oil more often in cold weather
▶ ★	Oil Filter	100 hrs./ 1000 mi.	6 months	Replace with oil change
★	Engine breather hose	100 hrs.	6 months	Inspect
	Carburetor float bowl	50 hrs.	6 months	Drain bowl periodically and prior to storage
■	Throttle Cable/ETC Switch	50 hrs.	6 months	Inspect; adjust; lubricate; replace if necessary
★	Choke (enricher) cable	50 hrs.	6 months	Inspect; adjust; lubricate; replace if necessary
	Coolant strength	100 hrs.	6 months	Inspect strength seasonal- ly; pressure test system annually
■	Drive belt	50 hrs.	6 months	Inspect; replace as needed
▶	Steering	50 hrs.	6 months	Inspect daily; lubricate
▶	Front suspension	50 hrs.	6 months	Inspect; lubricate; tighten fasteners
▶	Rear suspension	50 hrs.	6 months	Inspect; tighten fasteners

MAINTENANCE AND LUBRICATION

Periodic Maintenance Schedule

WARNING

Improperly performing the procedures marked with a ■ could result in component failure and lead to serious injury or death. Have an authorized Polaris dealer perform these services.

	Item	Hours/ Miles	Frequency	Remarks
▶	Drive chain(s)	50 hrs.	6 months	Inspect daily; adjust and lubricate if needed
★	Spark plug	100 hrs.	12 months	Inspect; replace as needed
▶	Rear axle	50 hrs.	6 months	Inspect bearings; lube
■ ★	Ignition Timing	100 hrs.	12 months	Inspect; adjust as needed
■ ★	Fuel system	100 hours	12 months	Check for leaks at tank cap, lines, fuel valve, filter, pump and carburetor; replace lines every two years
■	Fuel filter	100 hrs.	12 months	Replace annually
	Radiator	100 hrs.	12 months	Inspect; clean external surface
	Cooling system hoses	100 hrs.	12 months	Inspect
■	Clutches (drive and driven)	100 hrs.	12 months	Inspect; clean
	Engine mounts	100 hrs.	12 months	Inspect
■	Brake fluid	200 hrs.	24 months	Change every two years
■	Front wheel bearings	300 hrs.	36 months	Inspect; replace as needed
	Spark arrestor	300 hrs.	36 months	Clean out
★	Idle speed		As required	Adjust
■	Toe adjustment		As required	Periodic inspection; adjust when parts are replaced
	Headlight aim		As required	Adjust as needed

- ▶ More often under severe use, such as dirty or wet conditions
- ★ Emission Control System Service (California)
- Dealer service item

MAINTENANCE AND LUBRICATION

Periodic Maintenance Record

Use the following chart to record periodic maintenance.

Maintenance Interval Performed	Servicing Date	Servicing Dealer or Person	Remarks
10 hrs.			
20 hrs.			
50 hrs.			
100 hrs.			

MAINTENANCE AND LUBRICATION

Lubrication Guide

NOTE: Hours in the frequency column are based on 10 mph average. If service is due at 20 hours, the equivalent odometer reading would be 200 miles. Perform all services at whichever reading is reached first.

Lubrication Guide Key

- ▶ More often under severe use, such as wet or dusty conditions
- ★ Polaris Premium All Season Grease or grease conforming to NLGI No. 2, such as Conoco Superlube M or Mobilegrease Special
- Use Polaris Premium U-Joint Lube every 500 miles, before long periods of storage, or after pressure washing or submerging.

Item	Lube	Method	Frequency
Engine Oil	Polaris Premium 4 Synthetic 0W40	Add to proper level on dipstick.	Check level daily.
Brake Fluid	DOT 3 Only	Maintain level between fill lines. See page 39.	As required; change every two years or 200 hours
Transmission Oil	Polaris Premium Synthetic Gearcase Lube	See page 81 (400/500) or page 83 (600/700).	Check every 6 months/1000 miles. Change annually or at 100 hours
Front Gearcase Oil	Premium Drive Hub Fluid	See page 82.	Change annually or at 100 hours
Rear Gearcase Oil	Premium Synthetic Gearcase Lube (or GL5 80-90 weight gear lube)	See page 84 (600/700).	Change annually or at 100 hours
Front Prop Shaft Yoke (Fig. 1)	● Grease	Grease fittings (3 pumps maximum)	Every 3 months or 50 hours
Front Drive Axle (U Joint) (Fig. 2)	● Grease	Locate grease fitting and grease with grease gun.	Every 3 months or 50 hours
Ball Joint (Fig. 3)	▶ ★ Grease	Locate fitting on back side of struts and grease with grease gun.	Every 3 months or 50 hours

MAINTENANCE AND LUBRICATION

Lubrication Guide

(Fig. 1)

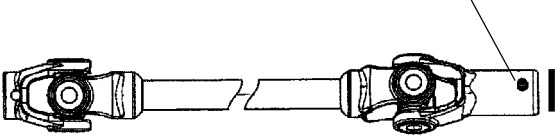

(Fig. 2)

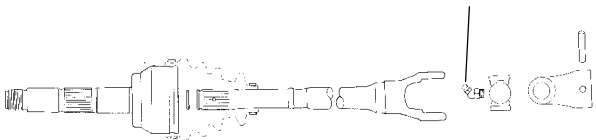

(Fig. 3)

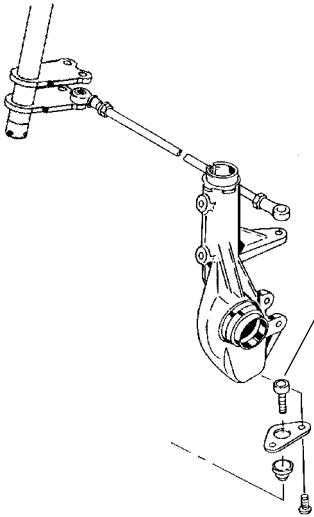

MAINTENANCE AND LUBRICATION

Premium 4 Synthetic Lubricant

Polaris Premium 4 All Season synthetic engine oil has been specially formulated for use in Polaris 4-cycle engines. It's a fully synthetic, high performance, multi-viscosity oil designed to provide the ultimate in lubrication performance and protection. **NOTE:** See page 115 for the part numbers of Polaris products.

Premium 4 possesses unsurpassed film strength over the widest possible temperature range. It resists viscosity and frictional breakdown in ambient temperatures from -40° F. to 120° F. (-40 to +49° C.) Its exceptional frictional properties result in more efficient operation, more power output and lower fuel consumption.

Although Polaris Premium 4 is the only oil recommended for use in this engine, use of any API certified *SH* oil is allowable as long as it's 0W-40. Oil may need to be changed more frequently if Polaris Premium 4 is not used. Follow the manufacturer's recommendations for ambient temperature operation.

CAUTION

Mixing brands or using a non-recommended oil may cause serious engine damage. We recommend the use of Polaris Premium 4 synthetic Oil or another 0W-40 API certified *SH* oil. Never substitute or mix oil brands.

MAINTENANCE AND LUBRICATION

Oil Check

The oil dipstick and fill tube (1) are located on the left side of the vehicle. **NOTE:** A rising oil level between checks in cool weather driving can indicate contaminants such as gas or moisture collecting in the crankcase. If the oil level is over the full/safe mark, change the oil immediately.

1. Position the ATV on a level surface.

2. Start the engine and let it idle for 20-30 seconds.

3. Stop the engine. Remove the dipstick and wipe it dry with a clean cloth. **NOTE:** If the dipstick is equipped with a lever lock (2), lift the lock to remove the dipstick.

4. Reinstall the dipstick completely, but do not lock it (if equipped). The dipstick must be completely seated to keep the angle and depth of the stick consistent.

5. Remove the dipstick and check the oil level. Maintain the oil level in the normal or safe range (3), depending on the style of dipstick in your model. Do not overfill. **NOTE:** Due to the dipstick entry angle into the crankcase (600/700 models), the oil level will read higher on the bottom side of the dipstick. Always read the level on the *upper* surface (4) of the dipstick.

6. After reinstalling the dipstick, be sure to seat the lever lock (if equipped).

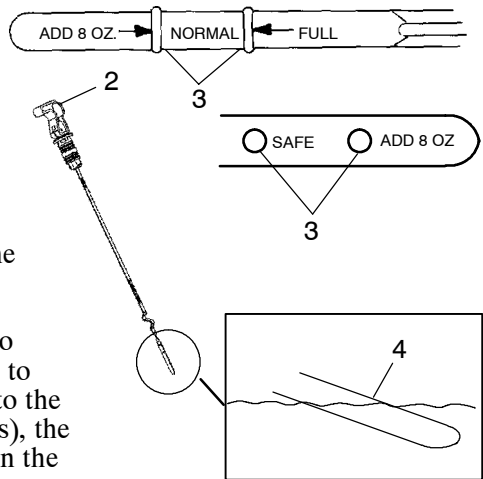
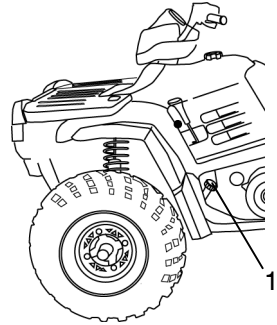

MAINTENANCE AND LUBRICATION

Oil and Filter Change

The recommended oil change interval is 100 hours, 1000 miles, or every six months, whichever comes first. Suggested break-in oil change is at 20 hours, 200 miles, or one month, whichever comes first. Severe use operation requires more frequent service. Severe use includes continuous duty in dusty or wet conditions and cold weather riding. **NOTE:** Severe use cold weather riding is all riding below 10° F., and riding between 10° F and 30° F when most trips are slow speed and less than five miles. Be sure to change the oil filter whenever changing the oil.

Oil Change (400/500)

1. Position the vehicle on a level surface. Clean the area around the drain plug at the bottom of the oil tank and the bottom of the engine.
2. Run the engine for two to three minutes, then turn it off.
3. Place a drain pan beneath the oil tank and remove the drain plug (1). Allow the oil to drain completely.
4. Install a new sealing washer (2) on the oil drain plug. **NOTE:** The sealing surfaces on the drain plug and the oil tank should be clean and free of burrs, nicks or scratches.
5. Reinstall the drain plug and torque to 14-17 ft. lbs. (19-23 Nm)
6. Disconnect the lower oil delivery hose and remove the screen fitting (3) from the oil tank. Clean and reinstall the fitting, torquing to 25 ft. lbs. Reattach the oil line. **NOTE:** The fitting threads must be sealed with Loctite™ PST 505 or PTFE seal tape. The fitting must also line up with the mark (4) on the rear side of the oil tank.

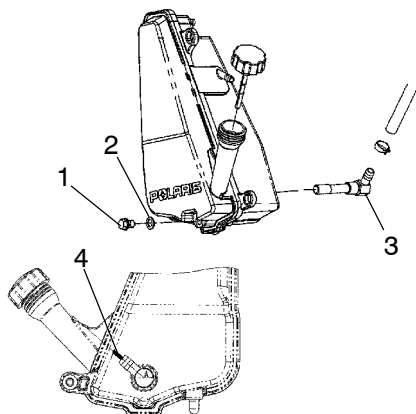

MAINTENANCE AND LUBRICATION

Oil Change (400/500)

- Place shop towels beneath the oil filter. Using an oil filter wrench, turn the filter (1) counterclockwise and remove.
- Lubricate the gasket on the new filter with a film of new engine oil. Check to make sure the gasket is in good condition. Also make sure the gasket from the old filter is not still on the engine.
- Install the new filter and tighten by hand 1/2 to 3/4 turn after gasket contacts the engine.
- Approximately one cup of engine oil will remain in the crankcase. To drain, remove the drain plug on the lower right side of the crankcase. **NOTE:** The sealing surfaces on the drain plug and crankcase should be clean and free of burrs, nicks or scratches.
- Reinstall the drain plug and torque to 14 ft. lbs. (19 Nm).
- Remove the dipstick (2) and add two quarts (1.9 l) of the recommended oil. Reinstall the dipstick. **NOTE:** If the sump is not drained, add about 1 3/4 quarts initially.
- Place the gear selector in neutral and set the parking brake.
- Prime the oil pump using the procedure below.** Then stop the engine and inspect for leaks.
- Recheck the oil level on the dipstick and add oil as necessary to bring it to the recommended level on the dipstick.
- Dispose of used filter and oil properly.

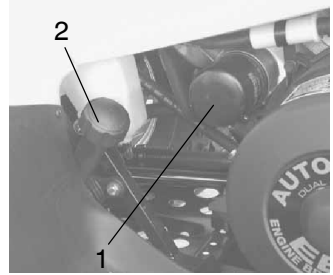

Oil Pump Priming

This priming procedure must be performed whenever the oil hose connection between the oil tank and pump inlet has been disconnected.

- Clamp or pinch off the vent line (1) approximately 2" from the oil tank (2), between the end of the oil tank vent fitting and the vent line's pressure relief slit (3).
- Run the engine for 10-20 seconds.
- Remove the vent line clamp. If the line is bled properly, you should hear a rush of air, indicating that the line is properly primed and ready for operation. *If you do not hear air, the line has not bled, and you'll need to repeat the priming procedure.*

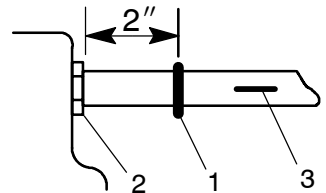

MAINTENANCE AND LUBRICATION

Oil Change (600/700)

1. Place the vehicle on a level surface.
2. Run the engine for two to three minutes until warm. Stop the engine.
3. Clean the area around the drain plug.
4. Place a drain pan beneath engine crankcase and remove the drain plug.

CAUTION

Hot oil can cause serious burns. Do not allow hot oil to touch skin.

5. Allow the oil to drain completely.
6. Replace the sealing washer on the drain plug. **NOTE:** The sealing surfaces on drain plug and crankcase should be clean and free of burrs, nicks or scratches.
7. Reinstall the drain plug and torque to 20 ft. lbs. (27 Nm).
8. Place shop towels beneath the oil filter. Using an oil filter wrench, turn the filter counterclockwise to remove.
9. Using a clean dry cloth, clean the filter sealing surface on the crankcase.
10. Lubricate the o-ring on the new filter with a film of fresh engine oil. Check to make sure the o-ring is in good condition.
11. Install the new filter and turn by hand until the filter gasket contacts the sealing surface, then turn an additional 1/2 turn.
12. Remove the dipstick and fill the sump with two quarts (1.9 l) of recommended oil.
13. Place the gear selector in PARK and set the parking brake.
14. Start the engine and let it idle for one to two minutes. Stop the engine and inspect for leaks.
15. Re-check the oil level on the dipstick and add oil as necessary to bring the level to the upper mark on the dipstick.
16. Dispose of used filter and oil properly.

MAINTENANCE AND LUBRICATION

Transmission Oil (400/500)

The transmission oil level should be checked every six months or 1000 miles (1600 km), whichever comes first. Transmission oil should be changed annually. We recommend the use of Polaris Premium Synthetic Gearcase Lubricant. See page 115 for the part numbers of Polaris products.

Oil Check

On the Sportsman 400 and 500, the transmission fill plug (1) is located on the left side of the ATV, under the rear fender, behind the wheel.

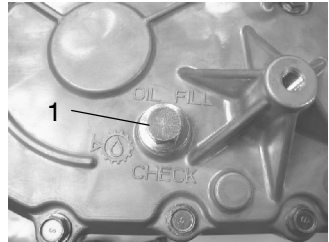
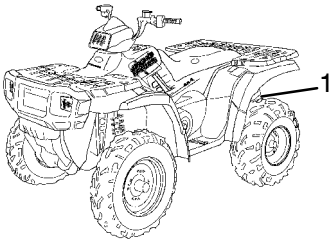

1. Position the ATV on a level surface and remove the fill plug.
2. Add the recommended oil as needed to bring the level to the bottom of the fill plug hole threads.

Oil Change

The transmission drain plug (2) is located on the right side of the gearcase, on the right side of the ATV, behind the wheel well.

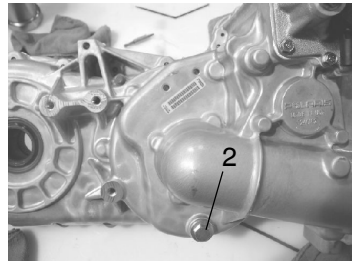
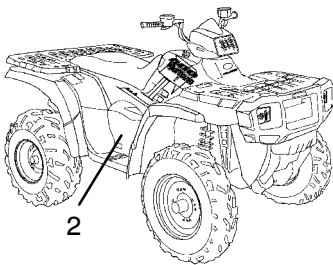

1. Remove the fill plug and the transmission drain plug.
2. Drain the oil into a drain pan and dispose of properly.
3. Clean and reinstall the drain plug.
4. Add 32 oz. (948 ml) of the recommended transmission oil to bring the level to the bottom of the fill plug.
5. Reinstall the fill plug and check for leaks.

MAINTENANCE AND LUBRICATION

Front Gearcase Oil

The front gearcase lubricant level should be checked every six months or 1000 miles (1600 km), whichever comes first. Front gearcase oil should be changed annually. We recommend the use of Polaris Premium Drive Hub Fluid. Use of non-recommended oils may result in improper operation of components. See page 115 for the part numbers of Polaris products.

Oil Check

1. Position the ATV on a level surface.
2. Remove the fill plug (1) and view the oil level. Maintain the oil level even with the bottom of the fill plug hole.
3. Add the recommended gearcase oil as needed.

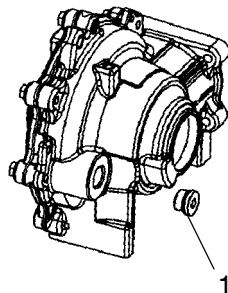

Oil Change

1. Position the vehicle on a level surface and remove the fill plug.
2. Place a drain pan beneath the gearcase, remove the gearcase drain plug located on the bottom right-hand side, and drain the oil.
3. Clean and reinstall the drain plug. Torque to 14 ft. lbs. (19 Nm).
4. Add 5 ounces (150 ml) of Polaris Premium Drive Hub Fluid.
5. Reinstall the fill plug and check for leaks.

MAINTENANCE AND LUBRICATION

Transmission Oil (600/700)

The transmission oil level should be checked every six months or 1000 miles (1600 km), whichever comes first. Transmission oil should be changed annually. We recommend the use of Polaris Premium Synthetic Gearcase Lubricant. See page 115 for the part numbers of Polaris products.

On the Sportsman 600 and 700, the transmission oil fill plug (1) is located on the right side of the ATV behind the footwell. The transmission drain plug (2), is located on the bottom left-hand side of the gearcase.

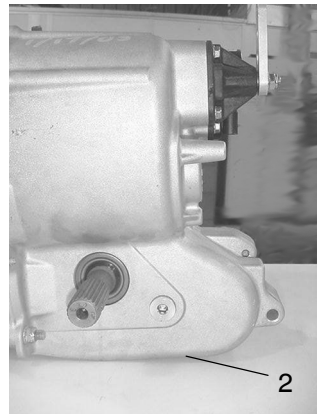
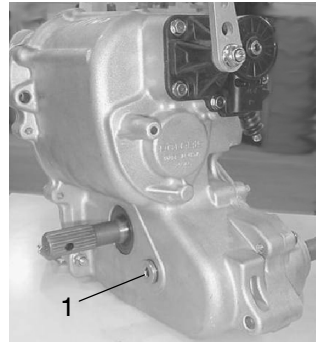

Oil Check

1. To access the fill plug, remove the four screws on the footwell and gently pull outward to remove the footwell.
2. Remove the fill plug and check the oil level. The oil should be maintained 1 5/8" from the top of the fill plug hole.

Oil Change

1. Remove the four screws on the footwell and gently pull outward to remove the footwell.
2. Remove the drain plug and drain the oil into a drain pan. Dispose of properly.
3. Clean and reinstall the drain plug. Torque to 14 ft. lbs. (19 Nm).
4. Remove the fill plug and add 13.5 oz. (399 ml) of the recommended transmission oil to bring the level to the proper level (1 5/8" from the top of the fill plug hole).
5. Replace the fill plug and check for leaks.
6. Reinstall the footwell and screws.

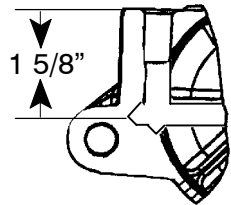

MAINTENANCE AND LUBRICATION

Rear Gearcase Oil (600/700)

The rear gearcase lubricant level should be checked every six months or 1000 miles (1600 km), whichever comes first. Rear gearcase oil should be changed annually. Use Polaris Premium Synthetic Gearcase Lube (or GL5 80-90 weight gear lube). **NOTE:** See page 115 for the part numbers of Polaris products.

Oil Check

1. Position the ATV on a level surface.
2. Remove the fill plug and inspect the oil level through the fill plug hole (1). Maintain the oil level even with the bottom of the fill plug hole.
3. Add the recommended gearcase oil as needed.

Oil Change

1. Place a drain pan beneath the drain and remove the drain plug (2). Catch and discard used oil properly.
2. Clean and reinstall the drain plug with a new sealing washer. Torque to 14 ft. lbs. (19 Nm).
3. Remove the fill plug and add 5 ounces (150 ml) of the recommended gearcase oil.
4. Inspect the oil level, which should be maintained level with the bottom of the fill plug hole.
5. Reinstall the fill plug. Torque to 14 ft. lbs. (19 Nm) and check for leaks.

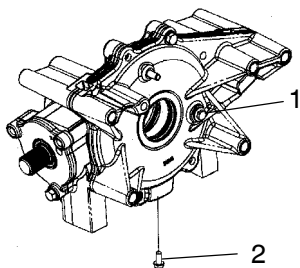

MAINTENANCE AND LUBRICATION

Engine Cooling System

Coolant Level

The recovery bottle (1) is located on the left side of the machine. To access the recovery bottle, remove the left side panel as outlined on page 90.

The fluid level must be maintained between the minimum and maximum marks on the bottle (when the fluid is cool).

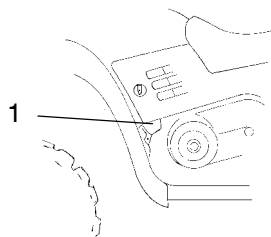

The engine coolant level is controlled or maintained by the recovery system. The recovery system components are the recovery bottle, radiator filler neck, radiator pressure cap and connecting hose.

As coolant operating temperature increases, the expanding (heated) excess coolant is forced out of the radiator, past the pressure cap, and into the recovery bottle. As engine coolant temperature decreases, the contracting (cooled) coolant is drawn back up from the tank, past the pressure cap, and into the radiator.

NOTE: Some coolant level drop on new machines is normal, as the system is purging itself of trapped air. Observe coolant levels and maintain as recommended by adding coolant to the recovery bottle.

Polaris recommends the use of Polaris Premium 60/40 anti-freeze/coolant or a 50/50 mixture of high quality aluminum compatible anti-freeze/coolant and distilled water. See page 115 for the part numbers of Polaris products.

NOTE: Polaris Premium 60/40 is already premixed and ready to use. Do not dilute with water.

NOTE: Always follow the manufacturer's mixing recommendations for the freeze protection required in your area.

MAINTENANCE AND LUBRICATION

Engine Cooling System

⚠WARNING

Escaping steam can cause severe burns. Never remove the pressure cap while the engine is warm or hot. Always allow the engine to cool before removing the pressure cap.

Radiator Coolant Level

NOTE: This procedure is required only if the cooling system has been drained for maintenance and/or repair. However, if the recovery bottle has run dry, the level in the radiator should be inspected and coolant added if necessary.

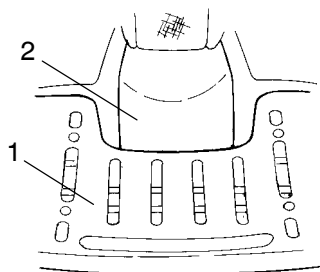

1. Using the tool provided, remove the four screws securing the front rack (1). Remove the front cover (2) by placing your fingers under the front of the cover and pulling upward.
2. Remove the pressure cap.
3. Using a funnel, slowly add coolant as necessary through the radiator filler neck.
4. Replace the pressure cap and secure the front cover and rack.

NOTE: Use of a non-standard pressure cap will not allow the recovery system to function properly. Contact your dealer for the correct replacement part.

NOTE: To ensure that the coolant maintains its ability to protect the engine, we recommend that the system be completely drained every two years and a fresh mixture of antifreeze and water added. Polaris recommends the use of Polaris Premium 60/40 anti-freeze/coolant or a 50/50 mixture of high quality aluminum compatible anti-freeze/coolant and distilled water. Polaris Premium 60/40 is already premixed and ready to use. Do not dilute with water. See page 115 for the part numbers of Polaris products.

NOTE: Always follow the manufacturer's mixing recommendations for the freeze protection required in your area.

MAINTENANCE AND LUBRICATION

Brakes

The front and rear brakes are hydraulic disc brakes, activated by moving the single brake lever toward the handlebar. These brakes are self-adjusting.

The following checks are recommended to keep the brake system in good operating condition. Check more often if brakes are used heavily under normal operation.

WARNING

Never store or use a partial bottle of brake fluid. Brake fluid is hygroscopic, meaning it rapidly absorbs moisture from the air. The moisture causes the boiling temperature of the brake fluid to drop, which can lead to early brake fade and the possibility of accident or severe injury. After opening a bottle of brake fluid, always discard any unused portion.

1. Always keep brake fluid at an adequate level (see page 39).

WARNING

An over-full master cylinder may cause brake drag or brake lock-up, which could result in serious injury or death. Maintain brake fluid at the recommended level. Do not overfill.

NOTE: Under normal operation, the diaphragm extends into the reservoir as fluid level drops. If the fluid level is low and the diaphragm is not extended, a leak is likely and the diaphragm should be replaced. Always fill the reservoir as needed whenever the cover is loosened or removed to ensure proper diaphragm operation. Use Polaris DOT 3 brake fluid. Do not overfill.

MAINTENANCE AND LUBRICATION

Brakes

2. Check the brake system for fluid leaks.
3. Check the brakes for excessive travel or spongy feel.
4. Check the friction pads for wear, damage and looseness.
5. Check the security and surface condition of the disc.

NOTE: Pads should be changed when worn to $3/64''$ (.1 cm), or about the thickness of a U.S. dime.

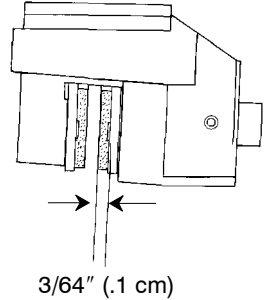

Auxiliary Brake

The auxiliary brake system is intended to be used as a backup for the main brake system. Should the main system fail, the rear brake can be activated by depressing the foot pedal on the inside of the right footrest. The hydraulic auxiliary brake system requires no adjustment.

NOTE: Since this is a rear brake only, it will not be as effective as the all-wheel single lever system.

MAINTENANCE AND LUBRICATION

Toe Alignment

⚠️WARNING

Severe injury or death can result from improper toe alignment and adjustment. Do not attempt to adjust tie rod alignment. All tie rod adjustments should be performed by an authorized Polaris dealer.

Use the following procedure to check the toe alignment of the vehicle. The recommended toe alignment is 1/8" to 1/4" toe out.

1. Set the handlebars in a straight-ahead position.
NOTE: The steering frog can be used as an indicator of whether the handlebars are straight. The frog should always point straight back from the steering post.
2. Place stands (1) in front of the vehicle, perpendicular to the rear tires. See illustration.
3. Tie an elastic string around the stands, making sure the string just touches the side surface of the rear tires on each side of the vehicle and goes around the stands in front of the vehicle (2).
4. Measure the distance from the string to the rim at the front and rear of the front rim (3). Rear measurement should be 1/16" - 1/8" (.2 to .3 cm) more than the front measurement.

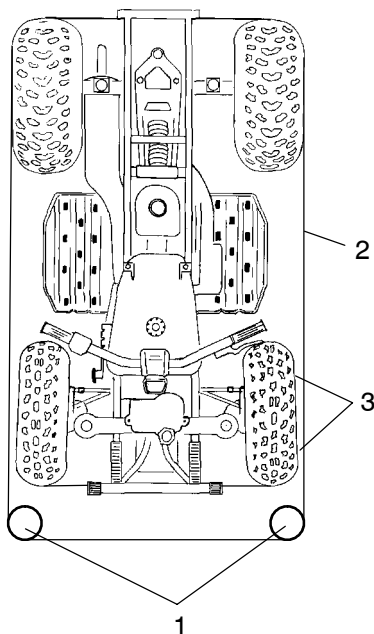

NOTE: If you discover improper alignment, see your Polaris dealer for service.

Steering Assembly

The steering assembly of the ATV should be checked periodically for loose nuts and bolts. If loose nuts and bolts are found, see your Polaris dealer for service before operating the vehicle.

MAINTENANCE AND LUBRICATION

Side Panel Removal

NOTE: Side panel removal may be difficult until the locking tabs and receivers have been snapped and unsnapped a few times.

1. Remove the seat.
2. Grasp the rear of the side panel near the rear cab. With a quick and firm motion, pull the panel forward and outward to disengage the two rear tabs.
3. Place your hand on top of the side panel behind the fuel tank. With a quick and firm motion, push down on the side panel to disengage the top rear two tabs. Then pull up on the side panel to disengage the front upper and lower tabs.
4. To reinstall the side panel, align the panel tabs with the slots on the front cab. Push the panel upward and forward until the tabs lock. Bend the rear of the side panel and insert the two tabs into the rear cab.

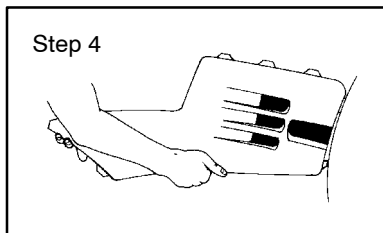
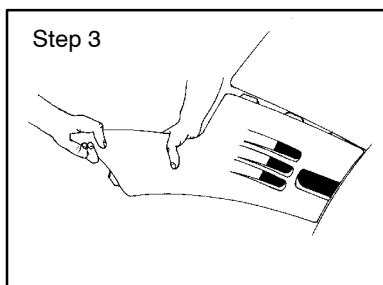
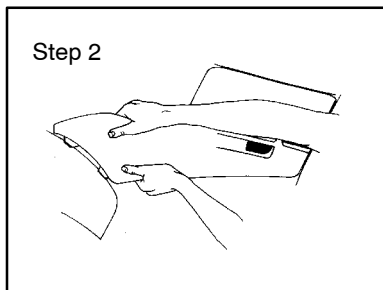

MAINTENANCE AND LUBRICATION

⚠️WARNING

Operating your ATV with worn tires, improperly inflated tires, non-standard tires or improperly installed tires will affect vehicle handling and could cause an accident resulting in serious injury or death.

Maintain proper tire pressure as described on the decal on your ATV and in the owner's manual.

Always use original equipment size and type when replacing tires.

Make sure the wheels are installed properly.

Always replace tires when the tread depth measures 1/8" (.3 cm) or less.

Tire Tread Depth

Always replace tires when tread depth is worn to 1/8" (.3 cm) or less. See illustration.

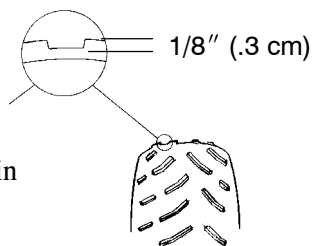

Wheel Removal

1. Stop the engine, place the transmission in PARK and lock the parking brake.
2. Loosen the wheel nuts slightly.
3. Elevate the side of the vehicle by placing a suitable stand under the footrest frame.
4. Remove the wheel nuts and remove the wheel.

MAINTENANCE AND LUBRICATION

Wheel Installation

1. Place the transmission in PARK and lock the parking brake.
2. Place the wheel on the wheel hub with the valve stem toward the outside and rotation arrows on the tire pointing toward forward rotation.
3. Install the wheel nuts and finger tighten.
4. Lower the vehicle to the ground.
5. Torque the wheel nuts according to the wheel nut torque specifications chart.

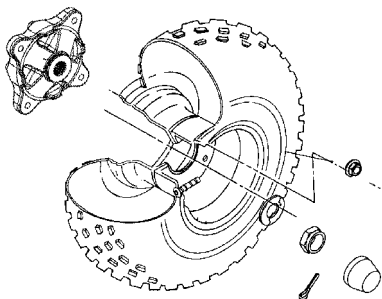

NOTE: All nuts that have a cotter pin installed must be serviced by an authorized Polaris dealer.

Wheel Nut Torque Specifications

Check the wheel nut torques occasionally and when they've been loosened for maintenance service.

Bolt Size	Sportsman 400/500	Sportsman 600/700
Front 3/8"	20 ft. lbs. (27 Nm)	30 ft. lbs. (41 Nm)
Rear 3/8"	20 ft. lbs. (27 Nm)	30 ft. lbs. (41 Nm)

Front Wheel Hub Tightening

Front wheel bearing tightness and spindle nut retention are critical component operations. All service must be performed by your authorized Polaris dealer.

MAINTENANCE AND LUBRICATION

Filter Systems

Air Filter Service

1. Remove the seat, release the air box cover clips, and remove the air box cover.
2. Loosen the clamp and remove the filter.
3. Remove the fabric type pre-filter (1) from the main filter (2). Wash the pre-filter in soapy water, then rinse and let dry.
4. Reinstall the pre-filter over the main filter. (Replace the main filter if needed.)
5. Reinstall the filter into the air box and tighten the clamp. Do not over tighten the clamp, as filter damage could occur.
6. Reinstall the air box cover and the seat.

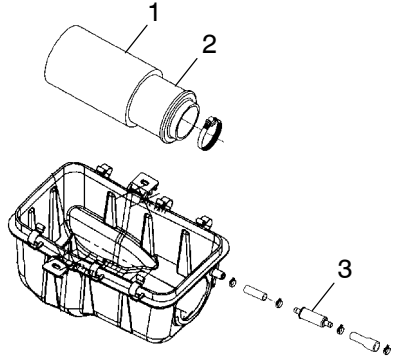

Breather Filter/Hose

1. To access the breather filter (3), remove the left side panel as outlined on page 90. The breather filter is on the hose that runs between the engine and air box.
2. Remove the clamps and pull the filter out of the hoses.
NOTE: It's not necessary to remove the lower hose from the engine.
3. Inspect the filter for debris. Blow gently through the filter in the direction of the arrow to check for clogging. Replace if needed.
4. Check the hoses for cracks, deterioration, abrasion, or leaks. Replace as needed.
5. Reinstall the filter and secure the clamps.
NOTE: The filter is effective with the arrow pointing in either direction.

CAUTION

Operation of your vehicle without a breather filter can cause engine damage. Always reinstall the breather filter after removing for service.

MAINTENANCE AND LUBRICATION

Lights

When servicing a halogen lamp, don't touch the lamp with bare fingers. Oil from your skin leaves a residue, causing a hot spot that will shorten the life of the lamp.

WARNING

Poor lighting while driving can result in severe injury or death. Headlight and taillight lenses become dirty during normal operation. Wash the headlights frequently to maintain lighting quality.

Hot components can cause serious burns to skin. Do not service the headlamps until they've cooled sufficiently.

Headlight Lamp Replacement

1. Remove the two screws on the lower front corners of the headlight pod.
2. Using a small flat-blade screwdriver, push in on the lock tab through the two small openings at the front of the headlight pod.
3. Lift the pod slightly while depressing the tabs.
4. Remove the screw in the back of the headlight pod.
5. Lift the pod cover and disconnect the speedometer harnesses from the speedometer. Unplug the indicator light harness and remove the pod cover.
6. Unplug the headlamp from the wiring harness. Be sure to pull on the connector, not on the wiring.
7. Remove the boot and locking collar from the back of the lamp housing.
8. Grasp the base of the lamp and lift it out.
9. Reverse the previous steps to replace the lamp and reassemble the pod. Apply dielectric grease to the light bulb socket before installing the new bulb. Make sure the tab on the lamp locates properly in the housing.

MAINTENANCE AND LUBRICATION

Lights

High Beam Adjustment

The headlight beam can be adjusted to any position desired by turning the adjusting knob on the bottom right side of the headlight pod.

1. Position the vehicle on a level surface with the headlight approximately 25 ft. (7.6 m) from a wall.
2. Measure the distance from the floor to the center of the headlight and make a mark on the wall at the same height.
3. Start the engine and turn the headlight switch to high beam.
4. Observe the headlight aim on the wall. The most intense part of the headlight beam should be aimed two inches (5.1 cm) below the mark placed on the wall. **NOTE:** Include rider weight on the seat when measuring.
5. Adjust the beam to the desired position by turning the adjustment knob either clockwise or counterclockwise.

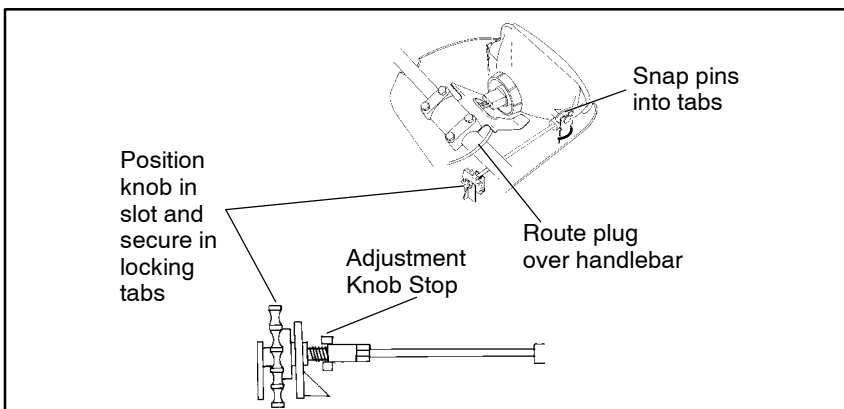

MAINTENANCE AND LUBRICATION

Lights

Headlight Housing Replacement

1. Remove the two screws on the lower front corners of the headlight pod.
2. Using a small flat-blade screwdriver, push in on the lock tab through the two small openings at the front of the headlight pod.
3. Lift the pod slightly while depressing the tabs.
4. Remove the screw in the back of the headlight pod.
5. Lift the pod cover. Disconnect the speedometer harnesses from the speedometer. Unplug the indicator light harness and remove the pod cover.
6. Unplug the headlamp from the wiring harness.
7. Pull the headlight housing up to release from the locking tabs.
8. Lift the adjusting knob up to remove from the locking tabs.
9. Carefully pull the assembly up and out of pod.
10. Reverse the steps to install the new housing and reassemble the pod.

NOTE: The distance from the headlamp parting line to the end of the adjustment knob stop is $5 \frac{1}{8}$ " (13 cm). See illustration.

11. Adjust the headlight aim by turning the adjusting knob.

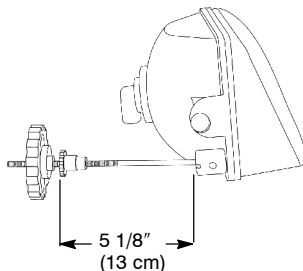

MAINTENANCE AND LUBRICATION

Lights

Lower Headlamp Removal / Installation

1. Turn the back of the headlight harness (1) in a clockwise direction.
2. Pull the harness assembly out from the headlight assembly.
3. Remove the headlamp and replace with a new headlamp.
4. Install the new headlamp and harness assembly into the headlight assembly. Turn the headlight harness counterclockwise to secure the headlamp into place.

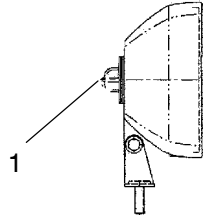

Taillight/Brakelight Lamp Replacement

If the taillight/brakelight does not work the lamp may need to be replaced.

1. Remove the taillight lens cover mounting screws (1). Remove the lens cover (2) and gasket and set aside for reassembly.
2. Remove the lamp (3) and replace it with a new lamp.
3. Test the taillight/brakelight to see that it's working.
4. Reinstall the gasket and lens cover.

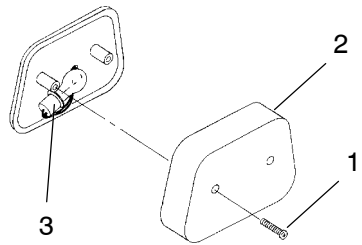

MAINTENANCE AND LUBRICATION

Spark Plugs

CAUTION

Using non-recommended spark plugs can result in serious engine damage. Always use Polaris-recommended spark plugs.

Polaris Model	Recommended Spark Plug
Sportsman 400	BKR5E
Sportsman 500	BKR6E
Sportsman 600	RC7YC
Sportsman 700	RC7YC

Spark plug condition is indicative of engine operation. The spark plug firing end condition should be read after the engine has been warmed up and the vehicle has been driven at higher speeds. Immediately check the spark plug for correct color.

WARNING

A hot exhaust system and engine can cause serious burns. Wear protective gloves when removing a spark plug for inspection.

1. Normal

The normal insulator tip is gray, tan or light brown. There will be few combustion deposits. The electrodes are not burned or eroded. This indicates the proper type and heat range for the engine and the service.

NOTE: The tip should not be white. A white insulator tip indicates overheating, caused by use of an improper spark plug or incorrect carburetion adjustments.

2. Wet Fouled

The wet fouled insulator tip is black. A damp oil film covers the firing end. There may be a carbon layer over the entire nose. Generally, the electrodes are not worn. General causes of fouling are excessive oil, use of non-recommended oil, improper use of the choke, or incorrect carburetion adjustments.

Spark Plug Removal and Replacement

1. Remove the spark plug cap.
2. Using the special wrench provided in the tool pouch, rotate the spark plug counterclockwise to remove.
3. Reverse the procedure for spark plug installation, using the recommended spark plug. Torque to 18 ft. lbs. (24 Nm).

MAINTENANCE AND LUBRICATION

Vehicle Immersion

CAUTION

If your vehicle becomes immersed, major engine damage can result if the machine is not thoroughly inspected. Take the vehicle to your dealer before starting the engine.

If it's impossible to take your ATV to a dealer before starting it, follow the steps outlined below.

1. Move the ATV to dry land or at the very least, to water below the footrests.
2. Check the air box for any water and dry it if water is present. Filter replacement is required if water intrusion is evident.
3. Turn the fuel valve off.
4. Remove the spark plug.
5. Loosen the carburetor drain screw (1).
6. Turn the engine over several times using the electric start.
7. Dry the spark plug and reinstall, or replace it with a new plug.
8. Tighten the carburetor drain screw.
9. Turn the fuel valve on.
10. Attempt to start the engine. If necessary, repeat the drying procedure.
11. Take the ATV to your dealer for service as soon as possible, whether you succeed in starting it or not.

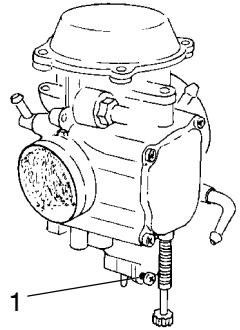

NOTE: If water has been ingested into the PVT, follow the procedure on page 102 for drying out the PVT.

MAINTENANCE AND LUBRICATION

Spark Arrestor

⚠️WARNING

Failure to heed the following warnings while servicing the spark arrestor could result in serious injury or death.

Do not perform service on the spark arrestor while the system is hot. Exhaust system temperatures can reach 1000° F. Allow components to cool sufficiently before proceeding.

Remove any combustible materials from the area. Wear eye protection and leather work gloves. Do not stand behind or in front of the vehicle while purging. Never run the engine in an enclosed area. Exhaust contains poisonous carbon monoxide gas.

Never go under the vehicle while it's inclined.

1. Remove the arrestor clean-out plug (1) from the bottom of the muffler.
2. Place the transmission in PARK and start the engine.
3. Purge carbon from the system by momentarily revving the engine several times.
4. If carbon is expelled, cover or plug the exhaust outlet (2) and rap on the pipe around the cleanout plug while revving the engine several more times.
5. If particles are still suspected to be in the muffler, elevate the rear of the vehicle one foot higher than the front. Set the parking brake and block the wheels. Make sure the vehicle is in PARK and repeat steps 3 and 4 until no more particles are expelled when the engine is revved.
6. Stop the engine and allow the arrestor to cool. Reinstall the arrestor plug and remove the outlet cover or plug.

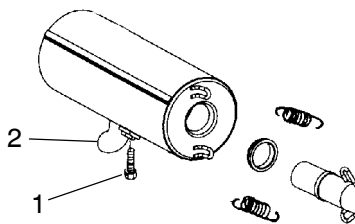

MAINTENANCE AND LUBRICATION

PVT System

The basic operation of the Polaris PVT system is dependent on engine speed and vehicle torque requirements. As engine speed increases, the force exerted on the movable drive sheave by the flyweights also increases. This, in turn, increases the amount of *pinch* applied to the drive belt. Similarly, if the engine speed decreases, the amount of centrifugal force decreases, reducing the amount of belt pinch.

On Polaris ATVs, the approximate gear ratio difference between high and low range is 1:2.25. This difference in gearing affects the operation of the PVT, especially at speeds less than 7 MPH (11 KPH), due to the system's dependence on engine speed.

For example, when operating at a ground speed of 3 MPH (5 KPH) in low range, the engine speed would be around 3000 RPM. This is well above the engagement speed of 1200 - 1400 RPM. However, in high range at 3 MPH (5 KPH), the engine would be running at only 1500 RPM. Whenever operating this close to the engagement speed, the engine may be running at a speed too low to provide the pinch needed to prevent belt slip. Belt slip is responsible for creating the excessive heat that destroys belts and causes outer clutch covers to fail.

By switching to low range while operating at low ground speeds, the air temperature in the clutch cover is reduced by almost 160 degrees. Reducing the temperature inside the clutch cover extends the life of the PVT components (belt, cover, etc.).

When To Use Low Range vs. High Range

Following is a guideline for when to use low range and high range.

Low Range

- When basic operation is at speeds less than 7 MPH (11 KPH)
- For heavy pulling
- When operating in rough terrain (swamps, mountains, etc.) at low ground speeds

High Range

- When basic operation is at speeds greater than 7 MPH (11 KPH)
- When operating at high ground speeds

MAINTENANCE AND LUBRICATION

PVT System

WARNING

Failure to comply with the instructions in this warning can result in severe injury or death.

Do not modify any component of the PVT system. Doing so may reduce its strength so that a failure may occur at a high speed. The PVT system has been precision balanced. Any modification will cause the system to be out of balance, creating vibration and additional loads on components.

The PVT system rotates at high speeds, creating large amounts of force on clutch components. Extensive engineering and testing has been conducted to ensure the safety of this product. However, as the owner, you have the following responsibilities to make sure this system remains safe:

Always follow all recommended maintenance procedures. See your dealer as outlined in the owner's manual.

This PVT system is intended for use on Polaris products only. Do not install it in any other product.

Always make sure the PVT housing is securely in place during operation.

PVT Drying

There may be some instances when water is accidentally ingested into the PVT system. Use the following instructions to dry it out before operating:

1. Remove the drain plug and allow the water to drain. Replace the drain plug.
2. Start the engine and shift the transmission into neutral. Apply varying throttle for 10-15 seconds to expel the moisture and air-dry the belt and clutches. Do not hold the throttle wide open for more than 10 seconds.
3. Allow the engine RPM to settle to idle speed, then shift the transmission to the lowest available range.
4. Test for belt slippage. If the belt slips, repeat the process.
5. Take the vehicle to your dealer for service as soon as possible.

MAINTENANCE AND LUBRICATION

Battery

Your ATV may have either a sealed battery, which requires little maintenance, or a conventional battery. A sealed battery can be identified by its flat covers on the top of the battery. A conventional battery has six filler caps on the top of the battery.

Always keep battery terminals and connections free of corrosion. If cleaning is necessary, remove corrosion with a stiff wire brush. Wash with a solution of one tablespoon baking soda and one cup water. Rinse well with tap water and dry off with clean shop towels. Coat the terminals with dielectric grease or petroleum jelly. Be careful not to allow cleaning solution or tap water into a conventional battery.

WARNING

Battery electrolyte is poisonous. It contains sulfuric acid. Serious burns can result from contact with skin, eyes or clothing.

Antidote:

External: Flush with water.

Internal: Drink large quantities of water or milk. Follow with milk of magnesia, beaten egg, or vegetable oil. Call physician immediately.

Eyes: Flush with water for 15 minutes and get prompt medical attention.

Batteries produce explosive gases. Keep sparks, flame, cigarettes, etc. away. Ventilate when charging or using in an enclosed space. Always shield eyes when working near batteries. **KEEP OUT OF REACH OF CHILDREN.**

MAINTENANCE AND LUBRICATION

Battery

Battery Removal

1. Disconnect the hold-down strap holding the battery in position, and remove battery cover.
2. On conventional batteries, remove the battery vent tube.
3. Disconnect the black (negative) battery cable first.
4. Disconnect the red (positive) battery cable next.
5. Lift the battery out of the ATV. Be careful not to tip a conventional battery sideways, which could spill electrolyte.

CAUTION

If electrolyte spills, immediately wash it off with a solution of one tablespoon baking soda and one cup water to prevent damage to the vehicle.

Battery Installation

1. Set the battery in the battery holder.
2. With conventional batteries, install the battery vent tube (sealed batteries do not have a vent tube). **NOTE:** The vent tube must be free of obstructions and securely installed. If not, battery gases could accumulate and cause an explosion. The tube should be routed away from the frame and body to prevent corrosion. Avoid skin contact with electrolyte, which can cause severe burns.
3. First connect and tighten the red (positive) cable.
4. Second connect and tighten the black (negative) cable.
5. Reinstall the battery cover and attach the hold-down strap.
6. Verify that cables are properly routed.

NOTE: When installing a new battery, make sure it's fully charged prior to its initial use. Using a new battery that has not been fully charged can damage the battery and result in a shorter life. It can also hinder vehicle performance.

MAINTENANCE AND LUBRICATION

Battery

Battery Storage

When the vehicle is placed in storage for three months or more, the battery should be removed, stored out of the sun in a cool, dry place and tested monthly. Before reusing, take the battery to your dealer for testing and recharging.

Power plug leads may need to be bent down so that the battery cover can be installed.

Replenishing Battery Fluid (Conventional Battery)

A poorly maintained battery will deteriorate rapidly. Check the battery fluid level often. The fluid level should be kept between the upper and lower level marks (1).

To refill use only distilled water. Tap water contains minerals that are harmful to a battery.

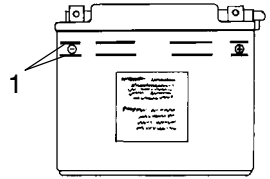

⚠️ WARNING

Improperly connecting or disconnecting battery cables can result in an explosion and cause serious injury or death. When removing the battery, always disconnect the negative (black) cable first. When reinstalling the battery, always connect the negative (black) cable last.

Battery Charging (Sealed Battery)

The following battery charging instructions apply only to the installation of a YUASA activated, sealed battery. Read all instructions before proceeding with the installation of this battery.

The YUASA activated, sealed battery is already filled with electrolyte and has been sealed and *fully charged* at the factory. *Do not ever* pry the sealing strip off or add any other fluid to this battery.

The single most important thing to maintaining a sealed battery is to keep it fully charged. Since the battery is sealed and the sealing strip cannot be removed, you must use a voltmeter or multimeter to measure DC voltage.

MAINTENANCE AND LUBRICATION

Battery

Battery Charging (Sealed Battery)

For a refresh charge, follow all instructions carefully.

1. Check the battery voltage with a voltmeter or multimeter. A fully charged battery will register 12.8 V or higher.
2. If the voltage is less than 12.8 volts, recharge the battery.

NOTE: When using an automatic charger, refer to the charger manufacturer's instructions for recharging. When using a constant current charger, use the following guidelines for recharging.

WARNING

An overheated battery could explode, causing severe injury or death. Always watch charging times carefully. Stop charging if the battery becomes very warm to the touch. Allow it to cool before resuming charging.

NOTE: Always verify battery condition before and 1-2 hours after the end of charging.

State of Charge	Voltage	Action	Charge Time* <small>(Using constant current charger @ standard amps specified on top of battery)</small>
100%	12.8-13.0 volts	None, check at 3 mos. from date of manufacture	None required
75%-100%	12.5-12.8 volts	May need slight charge, if no charge given, check in 3 months	3-6 hours
50%-75%	12.0-12.5 volts	Needs Charge	5-11 hours
25%-50%	11.5-12.0 volts	Needs Charge	At least 13 hours, verify state of charge
0%-25%	11.5 volts or less	Needs Charge	At least 20 hours

MAINTENANCE AND LUBRICATION

Accessories

Auxiliary power outlets provide 12V power for operating accessories such as hand held spot lights. Accessory outlets are available for all models. Polaris also has a wide range of additional accessories available for your ATV. See your Polaris dealer.

Cleaning and Storage

See page 115 for the part numbers of Polaris products.

Cleaning the ATV

Keeping your ATV clean will not only improve its appearance but it can also extend the life of various components. With a few precautions, your ATV can be cleaned much like an automobile.

Washing the ATV

The best and safest way to clean your ATV is with a garden hose and a pail of mild soap and water. Use a professional type washing mitten, cleaning the upper body first and the lower parts last. Rinse with water frequently and dry with a chamois to prevent water spots. **NOTE:** If warning and safety labels are damaged, contact your a Polaris dealer for free replacement.

Polaris does not recommend the use of a high pressure type car wash system for washing the ATV. If a high pressure system is used, exercise extreme care to avoid water damage to the wheel bearings, transmission seals, body panels, brakes and warning labels. **NOTE:** Grease all zerk fittings immediately after washing, and allow the vehicle to run for a while to evaporate any water that may have entered the engine or exhaust system.

Waxing the ATV

Your ATV can be waxed with any non-abrasive automotive paste wax. Avoid the use of harsh cleaners since they can scratch the body finish.

CAUTION

Certain products, including insect repellants and chemicals, will damage plastic surfaces. Use caution when using these products near plastic surfaces.

MAINTENANCE AND LUBRICATION

Cleaning and Storage

Storage Tips

CAUTION

Starting the engine during the storage period will disturb the protective film created by fogging and damage could occur. Never start the engine during the storage period.

Clean the Exterior

Make necessary repairs and then clean the ATV thoroughly with mild soap and warm water to remove all dirt and grime. Don't use harsh detergents or high pressure washers. Some detergents deteriorate rubber parts. Use dish soap type cleaners only. High pressure washers may force water past seals.

Stabilize the Fuel

Fill the fuel tank. Add Polaris Carbon Clean Fuel Treatment or Polaris Fuel Stabilizer. Follow the instructions on the container for the recommended amount. (Carbon clean will also reduce the possibility of bacterial growth in the fuel system.) Allow 15-20 minutes of operation for the stabilizer to disperse through the fuel in the tank and carburetor. Turn the fuel valve off and drain the carburetor bowl.

Oil and Filter

Warm the engine and change the oil and filter.

Air Filter / Air Box

Inspect and clean or replace the pre-cleaner and air filter. Clean the air box and drain the sediment tube.

Breather Filter

Inspect and clean or replace the breather filter.

Fluid Levels

Inspect the following fluid levels and change if necessary: front and rear gearcases; transmission and brake fluid (change every two years or as required if fluid looks dark or contaminated).

MAINTENANCE AND LUBRICATION

Cleaning and Storage

Storage Tips

Fog the Engine

1. Remove the spark plug and add 2-3 tablespoons of Premium 4 Synthetic 0W40 engine oil. To access the plug hole, use a section of clear 1/4" hose and a small plastic squeeze bottle filled with the pre-measured amount of oil. **NOTE:** Do this carefully! If you miss the plug hole, oil will drain from the spark plug cavity into the hole at the front of the cylinder head, and appear to be an oil leak.
2. Reinstall the spark plug. Torque to 18 ft. lbs. (24 Nm).
3. Apply dielectric grease to the inside of the spark plug cap and install the cap onto the plug.
4. Turn the engine over several times. Oil will be forced in and around the piston rings and ring lands, coating the cylinder with a protective film of fresh oil.

Alternative to Using Fogging Oil

If you choose not to use Polaris Fogging Oil, perform the following procedure.

1. Treat the fuel system with Polaris Carbon Clean, following the instructions on the can. Run the engine for several minutes so the Carbon Clean reaches the carburetor. Turn the engine off.
2. Support the front end of the machine so the engine is level or tilted slightly rearward.
3. Remove the spark plug. Rotate the piston to BDC and pour approximately two ounces of recommended oil into the cylinder.
4. Reinstall the spark plug and torque to 18 ft. lbs. (24 Nm).
5. Apply dielectric grease to the inside of the spark plug cap and install the cap onto the plug.
6. Turn the engine over several times to ensure coverage of piston rings, cylinder walls and crankshaft bearings.
7. If Polaris fuel system additive is not used, fuel tank, fuel lines, and carburetor should be completely drained of gasoline. To eliminate any fuel remaining in the carburetor, run the engine until it stops.

Inspect and Lubricate

Inspect all cables and lubricate. Follow lubrication guidelines in the Maintenance Section of the service or owner's manual to completely grease and lubricate the entire vehicle with Polaris Premium All Season Grease.

MAINTENANCE AND LUBRICATION

Cleaning and Storage

Storage Tips

Battery Maintenance (Conventional)

Remove the battery and add distilled water to the proper level. *Do not use tap water*, which may contain minerals that reduce battery life.

Apply dielectric grease to the terminal bolts and terminals. Charge the battery at 1.4 amps or less until the specific gravity of *each* cell is 1.265 or greater. Store the battery in a cool, dry place.

Charge can be maintained easily by using Polaris Battery Tender™ charger (PN 2871076) or by charging about once a month to make up for normal self-discharge. Battery Tender™ can be left connected during the storage period, and will automatically charge the battery if the voltage drops below a pre-determined point. Check the fluid level monthly.

Battery Maintenance (Sealed)

Remove the battery and recharge it as outlined on page 105. Store the battery in a cool, dry place.

Engine Anti-Freeze

Test engine coolant strength and change if necessary. Coolant should be replaced every two years.

Storage Area/Covers

Set the tire pressure and safely support the ATV with the tires 1-2" off the ground. Be sure the storage area is well ventilated, and cover the machine with a genuine Polaris ATV cover. **NOTE:** Do not use plastic or coated materials. They do not allow enough ventilation to prevent condensation, and may promote corrosion and oxidation.

MAINTENANCE AND LUBRICATION

Transporting the ATV

Follow these procedures when transporting the vehicle.

1. Turn off the engine and remove the key to prevent loss during transporting.
2. Place the transmission in PARK and lock the parking brake.
3. Turn the fuel valve off and be sure the fuel cap, oil cap and seat are installed securely.
4. Always tie the frame of the ATV to the transporting unit securely with suitable straps or rope. Do not attach tie straps to the front A-arm bolt pockets.

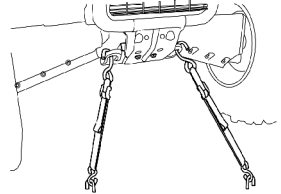
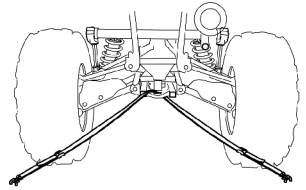
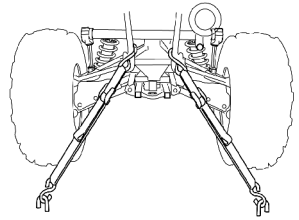

ADJUSTMENTS

Camber and Caster

The camber and caster are non-adjustable.

Rear Spring

The rear shock absorber spring is adjusted by rotating the adjuster (1) either clockwise or counterclockwise to increase or decrease spring tension.

NOTE: Accessory springs are available through your Polaris dealer.

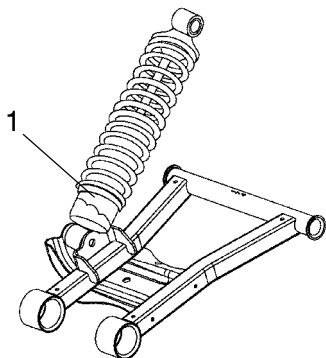

Handlebars

⚠ WARNING

Improper adjustment of the handlebars or incorrect torquing of the adjuster block tightening bolts can cause limited steering or loosening of the handlebars, resulting in loss of control and possible serious personal injury or death. Follow the adjustment procedures exactly, or see your Polaris dealer for service.

The handlebars can be adjusted for rider preference.

1. Locate handlebar bolts (1) by removing the upper headlight pod.
2. Loosen the four bolts.
3. Adjust the handlebar to the desired height. Be sure the handlebars do not contact the gas tank or any other part of the machine when turned fully to the left or right.
4. Torque the front two bolts to 10-12 ft. lbs. (14-17 Nm), then torque the rear two bolts. A gap of up to 1/8" will remain at the rear bolts.

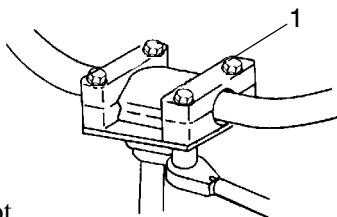

ADJUSTMENTS

Carburetor/Idle RPM

If the engine idle speed is not satisfactory, and all other conditions are favorable, the carburetor can be adjusted.

1. Warm up the engine by running the vehicle for approximately five minutes.
2. Place the transmission in gear with the parking brake applied.
3. Adjust the carburetor idle screw (1) either in or out until the desired idle RPM is reached. Turning the screw in (clockwise) will raise RPM. Turning the screw out (counterclockwise) will lower RPM.

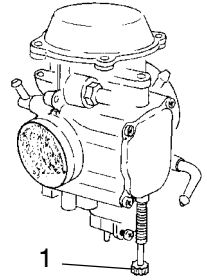

IMPORTANT: Your Polaris ATV is calibrated at the factory for optimal performance at altitudes ranging from zero to 6,000 feet (1800 m) and temperatures of +40 degrees F. (4 degrees C.) or higher. Above 6000 feet (1800 m) the engine air/fuel mixture becomes overly rich and the engine loses approximately 3% of its power for each 1000-foot (304.8 m) increase in elevation. Although this power cannot be regained, adjustments to the carburetor and drive system can be made to allow more efficient operation. Optional jets, available from your Polaris dealer, are required for operation above 6,000 feet and temperatures below +40 degrees F. (4 degrees C.)

NOTE: Continuous operation of the engine without proper jetting when required can cause poor performance, overheating or engine damage. See your Polaris dealer for more information about jetting the ATV for conditions in your area.

ADJUSTMENTS

Throttle Cable Freeplay

Throttle cable freeplay is adjusted at the handlebar.

1. Slide the boots (1) off the inline cable adjuster sleeve (2). Loosen the adjuster locknut (3).
2. Turn the adjuster until $1/16''$ to $1/8''$ freeplay is achieved at the thumb lever. **NOTE:** While adjusting freeplay, be sure to flip the throttle lever back and forth.
3. Tighten the locknut and slide the boots over the cable adjuster until they touch at the midpoint of the adjuster.

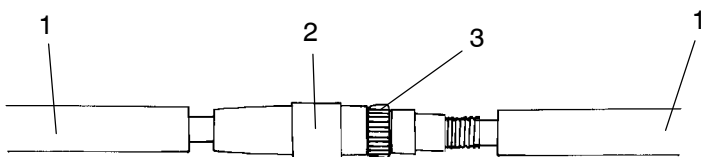

POLARIS PRODUCTS

Part No.	Description
Engine Lubricant	
2870791	Fogging Oil (12 oz. Aerosol)
2871281	Engine Oil (qt.) Premium 4 Synthetic 0W-40 (4-Cycle)
2871844	Engine Oil (gal.) Premium 4 Synthetic 0W-40 (4-Cycle)
Gearcase / Transmission Lubricants	
2871477	Premium Synthetic Gearcase Lubricant (1 gal.)
2871478	Premium Synthetic Gearcase Lubricant (12 oz. bottle)
2871653	Gear Drive Fluid (12 oz.)
2872276	Gear Drive Fluid (2.5 gal.)
2870465	Oil Pump for Gearcase Oil
2871654	Premium Drive Hub Fluid (8 oz.)
2872277	Premium Drive Hub Fluid (2.5 gal.)
Grease / Specialized Lubricants	
2871322	Premium All Season Grease (3 oz. cartridge)
2871423	Premium All Season Grease (14 oz. cartridge)
2871460	Starter Drive Grease
2871515	Premium U-Joint Lube (3 oz.)
2871551	Premium U-Joint Lube (14 oz.)
2871312	Grease Gun Kit
2871329	Dielectric Grease (Nyogel™)
2872073	Chain Lube (6.25 oz. aerosol)
2872348	Chain Lube (16 oz. aerosol)
Coolant	
2871323	60/40 Coolant (Gallon)
2871534	60/40 Coolant (Quart)
Additives / Miscellaneous	
2871326	Carbon Clean Plus (12 oz.)
2870652	Fuel Stabilizer (16 oz.)
2870990	DOT3 Brake Fluid
2872893	Engine Degreaser

TROUBLESHOOTING

Drive Belt and Cover Problems

Possible Cause	Solution
Driving the ATV onto a pickup or tall trailer in high range.	Shift transmission to low range during loading of the ATV to prevent belt burning.
Starting out going up a steep incline.	When starting out on an incline, use low range or dismount the ATV (after first applying the park brake) and perform the K-turn as described on page 63.
Driving at low RPM or low ground speed (at approximately 3-7 MPH).	Drive at a higher speed or use low range more frequently. The use of low range is highly recommended for cooler PVT operating temperatures and longer component life.
Insufficient warm-up of ATVs exposed to low ambient temperatures.	Warm the engine at least 5 minutes. With the transmission in neutral, advance the throttle to about 1/8 throttle in short bursts, 5 to 7 times. The belt will become more flexible and prevent belt burning.
Slow and easy clutch engagement.	Use the throttle quickly and effectively for efficient engagement.
Towing/pushing at low RPM/low ground speed.	Use low range only.
Utility use/plowing snow, dirt, etc.	Use low range only.
Stuck in mud or snow.	Shift the transmission to low range, and carefully use fast, aggressive throttle application to engage clutch. WARNING: Excessive throttle may cause loss of control and vehicle overturn.
Climbing over large objects from a stopped position.	Shift the transmission to low range, and carefully use fast, brief, aggressive throttle application to engage clutch. WARNING: Excessive throttle may cause loss of control and vehicle overturn.
Belt slippage from water or snow ingestion into the PVT system.	Shift the transmission to neutral. Using the throttle, vary the engine RPM from idle to full throttle. Repeat several times as required. During this procedure, the throttle should not be held at the full position for more than 10 seconds. Clutch seals should be inspected for damage if repeated leaking occurs.
Clutch malfunction.	Contact your Polaris dealer for inspection of clutch components.
Poor engine performance.	Check for fouled plugs or foreign material in gas tank, fuel lines, or carburetor. Contact your dealer for service.

TROUBLESHOOTING

Contact your Polaris dealer for service if you're unable to identify solutions using the following charts.

Engine Doesn't Turn Over

Possible Cause	Solution
Tripped circuit breaker	Reset the breaker
Low battery voltage	Recharge battery to 12.5 VDC
Loose battery connections	Check all connections and tighten
Loose solenoid connections	Check all connections and tighten

Engine Turns Over, Fails to Start

Possible Cause	Solution
Out of fuel	Refuel
Clogged fuel valve or filter	Inspect and clean or replace
Water is present in fuel	Drain the fuel system and refuel
Fuel valve is turned off	Turn the fuel valve on
Old or non-recommended fuel	Replace with new fuel
Fouled or defective spark plug(s)	Inspect plug(s), replace if necessary
No spark to spark plug	Inspect plug(s), verify stop switch is on
Crankcase filled with water or fuel	Immediately see your Polaris dealer
Overuse of choke	Inspect, clean and/or replace spark plugs
Clogged fuel filter	Replace the filter
Low battery voltage	Recharge battery to 12.5 VDC
Mechanical failure	See your Polaris dealer

Engine Pings or Knocks

Possible Cause	Solution
Poor quality or low octane fuel	Replace with recommended fuel
Incorrect ignition timing	See your Polaris dealer
Incorrect spark plug gap or heat range	Set gap to specs or replace plugs

TROUBLESHOOTING

Engine Backfires

Possible Cause	Solution
Weak spark from spark plugs	Inspect, clean and/or replace spark plugs
Incorrect spark plug gap or heat range	Set gap to specs or replace plugs
Old or non-recommended fuel	Replace with new fuel
Incorrectly installed spark plug wires	See your Polaris dealer
Incorrect ignition timing	See your Polaris dealer
Mechanical failure	See your Polaris dealer

Engine Runs Irregularly, Stalls or Misfires

Possible Weak Spark Cause	Solution
Fouled or defective spark plugs	Inspect, clean and/or replace spark plugs
Worn or defective spark plug wires	See your Polaris dealer
Incorrect spark plug gap or heat range	Set gap to specs or replace plugs
Loose ignition connections	Check all connections and tighten
Water present in fuel	Replace with new fuel
Low battery voltage	Recharge battery to 12.5 VDC
Kinked or plugged fuel vent line	Inspect and replace
Incorrect fuel	Replace with recommended fuel
Clogged air filter	Inspect and clean or replace
Reverse speed limiter malfunction	See your Polaris dealer
Electronic throttle control malfunction	See your Polaris dealer
Other mechanical failure	See your Polaris dealer
Possible Lean Fuel Mixture Cause	Solution
Low or contaminated fuel	Add or change fuel, clean the fuel system
Low octane fuel	Replace with recommended fuel
Clogged fuel filter	Replace filter
Incorrect jetting	See your Polaris dealer
Possible Rich Fuel Mixture Cause	Solution
Overuse of choke	Inspect, clean and/or replace spark plugs
Fuel is very high octane	Replace with lower octane fuel
Incorrect jetting	See your Polaris dealer

TROUBLESHOOTING

Engine Stops or Loses Power

Possible Cause	Solution
Out of fuel	Refuel
Kinked or plugged fuel vent line	Inspect and replace
Water present in fuel	Replace with new fuel
Overuse of choke	Inspect, clean and/or replace spark plugs
Fouled or defective spark plugs	Inspect, clean and/or replace spark plugs
Worn or defective spark plug wires	See your Polaris dealer
Incorrect spark plug gap or heat range	Set gap to specs or replace plugs
Loose ignition connections	Check all connections and tighten
Low battery voltage	Recharge battery to 12.5 VDC
Incorrect fuel	Replace with recommended fuel
Clogged air filter	Inspect and clean or replace
Reverse speed limiter malfunction	See your Polaris dealer
Electronic throttle control malfunction	See your Polaris dealer
Other mechanical failure	See your Polaris dealer
Overheated engine	Clean radiator screen and core Clean engine exterior See your Polaris dealer

Engine Overheating

Possible Cause	Solution
Debris lodged in screen	Remove and clean the screen. Pull on the top portion of the screen, then remove the lower portion.
Plugged Radiator	Use a garden hose to flush any debris from the radiator fins. NOTE: High pressure washers can deform the radiator fins and reduce cooling efficiency.

SPECIFICATIONS

SPORTSMAN 400	
Gross Vehicle Weight	1200 lbs./544 kg
Towing Capacity	1225 lbs./556 kg
Hitch Tongue Capacity	120 lbs./54 kg (Rear rack weight and tongue weight not to exceed 180 lbs./81.6 kg)
Front Rack Capacity	90 lbs./40.8 kg
Rear Rack Capacity	180 lbs./81.6 kg
Overall Length	81 in./205.7 cm
Overall Width	46 in./119.3 cm
Overall Height	47 in./119.4 cm
Wheelbase	50.5 in./128.3 cm
Ground Clearance	11 in./27.9 cm (Base model) 11.25 in./28.6 cm (Hunter)
Dry Weight	697 lbs./316 kg (Base model) 739 lbs./335 kg (New Break-Up/Shadow/Hunter)
Minimum Turning Radius	65 in./165 cm
Fuel Capacity	4.25 gal./16 l
Engine Oil Capacity	2 qts./1.9 l
Coolant Capacity	2.25 qts./2.13 l
Engine	EH42PLE05
Displacement	425
Bore x Stroke	87.9 x 70
Pilot Jet	40
Main Jet	172.5
Needle Jet	Q-0M
Jet Needle	4GAC33-3
Pilot Screw	2 3/4 turn (taper 12.5°)(Brass plug)
Alternator Output	240 w
Compression Ratio	9:2 Full Stroke
Carburetor	34mm CV Mikuni
Ignition System	Digital CDI
Ignition Timing	30° +/- 2° @ 5000 RPM
Spark Plug / Gap	NGK BKR5E / .035 in. (0.9 mm)
Lubrication System	Dry Sump
Driving System Type	Automatic PVT (Polaris Variable Transmission)

SPECIFICATIONS

SPORTSMAN 400

Shift Type	Side Lever (H/L/N/R/P)
Gear Reduction - Low	23.91/1
Gear Reduction - Reverse	16.30/1
Gear Reduction - Forward	10.49/1
Drive Ratio - Front	3.82/1
Tire, Front	25 x 8 - 12 (5 psi)
Tire, Rear	25 x 11 - 12 (5 psi)
Front Brake	Hydraulic Disc
Rear Brake	Hydraulic, opposed piston caliper, fixed disc
Auxiliary Brake	Hydraulic, opposed piston caliper, fixed disc
Parking Brake	Hydraulic lock, all wheel
Front Suspension	MacPherson Strut with 6.7" (17 cm) of travel
Rear Suspension	Progressive Rate with 9.5" (24.1 cm) of travel
Shock Adjustment	Rear Spring Preload Adjust
Headlight	1 - Single Beam on handlebar (50 w) 2 - Single Beam on grill (27 w)
Taillights	8.26 w
Brakelight	26.9 w
Instrument Cluster	LCD

Jetting Chart

Altitude	AMBIENT TEMPERATURE	Below 40° F Below 5° C	+40° F and above +5° C and above
Meters (Feet)	0-1800 (0-6000)	177.5	172.5
	1800-3700 (6000-12000)	170	165

Clutching Chart

Altitude		Shift Weight	Drive Clutch Spring	Driven Clutch Spring	Helix and Spring Setting
Meters (Feet)	0-1800 (0-6000)	10 BH PN 5630711	Blue/Green PN 7041157	Black PN 7041782	34-38° PN 5133920 2+2
	1800-3700 (6000-12000)	20-40 PN 5631356	Blue/Green PN 7041157	Black PN 7041782	34-38° PN 5133920 2+2

SPECIFICATIONS

SPORTSMAN 500	
Gross Vehicle Weight	1200 lbs./544 kg
Hitch Towing Rating	1225 lbs./556 kg
Unbraked Trailer Towing Capacity*	1786 lbs./810 kg
Hitch Tongue Capacity	120 lbs./54 kg (Rear rack weight and tongue weight not to exceed 180 lbs./81.6 kg)
Front Rack Capacity	90 lbs./40.8 kg
Rear Rack Capacity	180 lbs./81.6 kg
Overall Length	81 in./205.7 cm
Overall Width	46 in./116.8 cm
Overall Height	47 in./119.4 cm
Wheelbase	50.5 in./128.3 cm
Ground Clearance	11.25 in./28.6 cm
Dry Weight	697 lbs./316 kg (HO) 739 lbs./335 kg (New Break-Up/Shadow/Hunter)
Minimum Turning Radius	65 in./165 cm
Fuel Capacity	4.25 gal./16 l
Engine Oil Capacity	2 qts./1.9 l
Coolant Capacity	2.25 qts./2.13 l
Engine	EH50PLE13
Displacement	498
Bore x Stroke	92 x 75
Pilot Jet	40
Main Jet	155
Needle Jet	X-6M
Jet Needle	6MGHI 194-3
Pilot Screw	2 Turn (Brass plug)
Alternator Output	240 w
Compression Ratio	10:2 Full Stroke
Carburetor	40mm CV Mikuni
Ignition System	CDI
Ignition Timing	30 BTDC @ 5000 RPM
Spark Plug / Gap	NGK BKR6E / .035 in. (0.9 mm)
Lubrication System	Dry Sump
Driving System Type	Automatic PVT (Polaris Variable Transmission)

* Based on EU Directive 76/432/EC

SPECIFICATIONS

SPORTSMAN 500

Shift Type	Side Lever (H/L/N/R/P)
Gear Reduction - Low	23.91/1
Gear Reduction - Reverse	16.30/1
Gear Reduction - Forward	10.49/1
Drive Ratio - Front	3.82/1
Tire, Front	25 x 8 - 12 (5 psi)
Tire, Rear	25 x 11 - 12 (5 psi)
Front Brake	Hydraulic Disc
Rear Brake	Hydraulic, opposed piston caliper, fixed disc
Auxiliary Brake	Hydraulic, opposed piston caliper, fixed disc
Parking Brake	Hydraulic lock, all wheel
Front Suspension	MacPherson Strut with 6.7" (17 cm) of travel
Rear Suspension	Progressive Rate with 9.5" (24.1 cm) of travel
Shock Adjustment	Rear Spring Preload Adjust
Headlight	1 Single Beam on Handlebar (50 w) 2 Single Beam on Grill (27 w)
Taillights	8.26 w
Brakelight	26.9 w
Instrument Cluster	LCD

Jetting Chart

Altitude	AMBIENT TEMPERATURE	Below 40° F Below 5° C	+40° F and above +5° C and above
Meters (Feet)	0-1800 (0-6000)	160	155
	1800-3700 (6000-12000)	152.5	147.5

Clutching Chart

Altitude		Shift Weight	Drive Clutch Spring	Driven Clutch Spring	Helix*
Meters (Feet)	0-1800 (0-6000)	10 WH PN 5630710	Blue/Green PN 7041157	White/Yellow PN 7041635	EBS PN 5131674
	1800-3700 (6000-12000)	10 RH PN 5630709	Blue/Green PN 7041157	White/Yellow PN 7041635	EBS PN 5131674

*EBS models require no helix / spring adjustment

SPECIFICATIONS

SPORTSMAN 600	
Gross Vehicle Weight	1240 lbs./563 kg
Fuel Capacity	4.25 gal./16 l
Towing Capacity	1500 lbs./681 kg
Hitch Tongue Capacity	150 lbs./68.1 kg (Rear rack capacity and tongue weight not to exceed 200 lbs./90.7 kg)
Front Rack Capacity	100 lbs./45.4 kg
Rear Rack Capacity	200 lbs./90.8 kg
Overall Length	81 in./205.7 cm
Overall Width	46 in./116.8 cm
Overall Height	47 in./119.4 cm
Wheelbase	50.75 in./128.9 cm
Ground Clearance	11.25 in./28.6 cm
Dry Weight	740 lbs./336 kg
Minimum Turning Radius	71.5 in./181.6 cm unloaded
Engine Oil Capacity	2 qts./1.9 l
Coolant Capacity	3.2 qts./3 l
Engine	EH059OLE024
Displacement	597
Bore x Stroke	76.5 x 65
Pilot Jet	45
Main Jet	157.5
Needle Jet	P-6(829)
Jet Needle	4HB41-3
Pilot Screw	2 3/8
Alternator Output	330 Watts @ 3000 rpm
Compression Ratio	9.35:1
Starting System	Electric
Carburetor	BST 34mm Mikuni
Ignition System	CDI
Ignition Timing	13° BTDC @ 1200 RPM
Spark Plug / Gap	RC7YC / .035 in. (0.9 mm)
Lubrication System	Pressurized Wet Sump
Driving System Type	4 Wheel Independent Shaft

SPECIFICATIONS

SPORTSMAN 600

Shift Type	Side Lever (H/L/N/R/P)
Gear Reduction - Low	7.5/1
Gear Reduction - Reverse	5.11/1
Gear Reduction - High	3.09/1
Drive Ratio - Front	3.82/1
Drive Ratio - Final	3.10/1
Tire Size - Front	25 x 8 - 12 (5 psi)
Tire Size - Rear	25 x 11 - 12 (5 psi)
Front Brake	Hydraulic Disc
Rear Brake	Hydraulic
Parking Brake	Hydraulic lock, all wheel
Front Suspension	MacPherson Strut with 6.7" (17 cm) of travel
Rear Suspension	Progressive Rate with 9.5" (24.1 cm) of travel
Shock Adjustment	Rear Spring Preload Adjust
Headlight (watts)	1 - Single Beam on Handlebar (50 w) 2 - Single Beam on Grill (27 w)
Taillights	8.26 w
Brake Light	26.9 w
Instrument Cluster	LCD

Jetting Chart

Altitude	AMBIENT TEMPERATURE	Below 40° F Below 5° C	+40° F and above +5° C and above
Meters (Feet)	0-1800 (0-6000)	162.5	157.5
	1800-3700 (6000-12000)	155	150

Clutching Chart

Altitude		Shift Weight	Drive Clutch Spring	Driven Clutch Spring	Helix*
Meters (Feet)	0-1800 (0-6000)	10 MH PN 5630513	Blue/Green PN 7041157	White/Yellow PN 7041635	EBS PN 5132751
	1800-3700 (6000-12000)	10 WH PN 5630710	Blue/Green PN 7041157	White/Yellow PN 7041635	EBS PN 5132751

*EBS models require no helix / spring adjustment

SPECIFICATIONS

SPORTSMAN 700	
Gross Vehicle Weight	1240 lbs./563 kg
Fuel Capacity	4.25 gal./16 l
Towing Rating	1500 lbs./681 kg
Unbraked Trailer Towing Capacity*	1914 lbs./868 kg
Front Rack Capacity	100 lbs./45.4 kg
Rear Rack Capacity	200 lbs./90.7 kg
Hitch Tongue Capacity	150 lbs./68.1 kg (Rear rack capacity and tongue weight not to exceed 200 lbs./90.8 kg)
Overall Length	81 in./205.7 cm
Overall Width	46 in./116.8 cm
Overall Height	47 in./119.4 cm
Wheelbase	50.75 in./128.9 cm
Ground Clearance	11.25 in./28.6 cm
Dry Weight	747 lbs./339 kg
Minimum Turning Radius	76 in./193 cm unloaded
Engine Oil Capacity	2 qts./1.9 l
Coolant Capacity	3.2 qts./3 l
Engine	EH068OLE015
Displacement	683
Bore x Stroke	80 x 68
Pilot Jet	45
Main Jet	157.5
Needle Jet	P-6(829)
Jet Needle	4HB41-4
Pilot Screw	2 3/8
Alternator Output	330 Watts @ 3000 rpm
Compression Ratio	9.78:1
Starting System	Electric
Carburetor	BST 34mm Mikuni
Ignition System	CDI
Ignition Timing	13° BTDC @ 1200 RPM
Spark Plug / Gap	RC7YC / .035 in. (0.9 mm)
Lubrication System	Pressurized Wet Sump
Driving System Type	4 Wheel Independent Shaft

* Based on EU Directive 76/432/EC

SPECIFICATIONS

SPORTSMAN 700

Shift Type	Side Lever (H/L/N/R/P)
Gear Reduction - Low	7.5/1
Gear Reduction - Reverse	5.11/1
Gear Reduction - High	2.7/1
Drive Ratio - Front	3.82/1
Drive Ratio - Final	3.10/1
Tire Size - Front	25 x 8 - 12 (5 psi)
Tire Size - Rear	25 x 11 - 12 (5 psi)
Front Brake	Hydraulic Disc
Rear Brake	Hydraulic
Parking Brake	Hydraulic lock, all wheel
Front Suspension	MacPherson Strut with 6.8" (17.3 cm) of travel
Rear Suspension	Progressive Rate with 9.8" (24.9 cm) of travel
Shock Adjustment	Rear Spring Preload Adjust
Headlight	1 - Single Beam on Handlebar (50 w) 2 - Single Beam on Grill (27 w)
Taillights	8.26 w
Brake Light	26.9 w
Instrument Cluster	LCD

Jetting Chart

Altitude	AMBIENT TEMPERATURE	Below 40° F Below 5° C	+40° F and above +5° C and above
Meters (Feet)	0-1800 (0-6000)	162.5	157.5
	1800-3700 (6000-12000)	155	150

Clutching Chart

Altitude	Shift Weight	Drive Clutch Spring	Driven Clutch Spring	Helix*	
Meters (Feet)	0-1800 (0-6000)	20-56 PN 5631315	Blue/Green PN 7041157	White/Yellow PN 7041635	EBS 41-37 PN 5132751
	1800-3700 (6000-12000)	20-54 PN 5631214	Blue/Green PN 7041157	White/Yellow PN 7041635	EBS 41-37 PN 5132751

*EBS models require no helix / spring adjustment

WARRANTY

LIMITED WARRANTY

Polaris Sales Inc., 2100 Highway 55, Medina, MN 55340, gives a SIX MONTH LIMITED WARRANTY on all components of the Polaris All Terrain Vehicle (ATV) against defects in material or workmanship. Polaris also gives a one year limited warranty on the final drive chain for failure due to defects. This warranty covers the parts and labor charges for repair or replacement of defective parts which are covered by this warranty. This warranty begins on the date of purchase. This warranty is transferrable to another consumer during the warranty period through a Polaris dealer.

REGISTRATION

At the time of sale, the Warranty Registration Form must be completed by your dealer and submitted to Polaris within ten days. Upon receipt of this registration, Polaris will record the registration for warranty.

THE PURCHASER MUST COMPLETE AN ATV SAFETY TRAINING COURSE PROVIDED BY THE DEALER IN ORDER TO HAVE VALID WARRANTY ON THE ATV. No verification of registration will be sent to the purchaser as the copy of the Warranty Registration Form will be the warranty entitlement. If you have not signed the original registration and received the customer copy, please contact your dealer immediately. **NO WARRANTY COVERAGE WILL BE ALLOWED UNLESS YOUR ATV IS REGISTERED WITH POLARIS.**

Initial dealer preparation and set-up of your ATV is very important in ensuring trouble-free operation. Purchasing a machine in the crate or without proper dealer set-up will void your warranty coverage.

WARRANTY

WARRANTY COVERAGE AND EXCLUSIONS:

LIMITATIONS OF WARRANTIES AND REMEDIES

The Polaris limited warranty excludes any failures that are not caused by a defect in material or workmanship. This warranty does not cover accidental damage, normal wear and tear, abuse or improper handling. This warranty also does not cover any ATV that has been altered structurally, modified, neglected, improperly maintained, used for racing, or used for purposes other than for which it was manufactured, or for any damages which occur during trailer transit or as a result of unauthorized service or the use of unauthorized parts. In addition, this warranty does not cover physical damage to paint or finish, stress cracks, tearing or puncturing of upholstery material, corrosion, or defects in parts, components or the ATV due to fire, explosions or any other cause beyond Polaris' control.

This warranty does not cover the use of unauthorized lubricants, chemicals, or fuels that are not compatible with the ATV. The exclusive remedy for breach of this warranty shall be, at Polaris' exclusive option, repair or replacement of any defective materials, or components or products. **THE REMEDIES SET FORTH IN THIS WARRANTY ARE THE ONLY REMEDIES AVAILABLE TO ANY PERSON FOR BREACH OF THIS WARRANTY. POLARIS SHALL HAVE NO LIABILITY TO ANY PERSON FOR INCIDENTAL, CONSEQUENTIAL OR SPECIAL DAMAGES OF ANY DESCRIPTION, WHETHER ARISING OUT OF EXPRESS OR IMPLIED WARRANTY OR ANY OTHER CONTRACT, NEGLIGENCE, OR OTHER TORT OR OTHERWISE.** Some states do not permit the exclusion or limitation of incidental or consequential damages or implied warranties, so the above limitations or exclusions may not apply to you if inconsistent with controlling state law.

WARRANTY

ALL IMPLIED WARRANTIES (INCLUDING BUT NOT LIMITED TO THE IMPLIED WARRANTIES OF MERCHANTABILITY AND FITNESS FOR A PARTICULAR PURPOSE) ARE LIMITED IN DURATION TO THE ABOVE SIX MONTH WARRANTY PERIOD. POLARIS FURTHER DISCLAIMS ALL EXPRESS WARRANTIES NOT STATED IN THIS WARRANTY. Some states do not allow limitations on how long an implied warranty lasts, so the above limitation may not apply to you if inconsistent with controlling state law.

HOW TO OBTAIN WARRANTY SERVICE

If your ATV requires warranty service, you must take it to a Polaris dealer authorized to repair Polaris ATVs. When requesting warranty service you must present your copy of the Warranty Registration form to the dealer. (THE COST OF TRANSPORTATION TO AND FROM THE DEALER IS YOUR RESPONSIBILITY). Polaris suggests that you use your original selling dealer; however, you may use any Polaris Servicing Dealer to perform warranty service.

Please work with your dealer to resolve any warranty issues. Should your dealer require any additional assistance they will contact the appropriate person at Polaris.

This warranty gives you specific legal rights, and you may also have other rights which vary from state to state.

If any of the above terms are void because of state or federal law, all other warranty terms will remain in effect.

Engine Oil

1. Mixing oil brands or using non-recommended oil may cause engine damage. We recommend the use of Polaris engine oil for your ATV.
2. Damage resulting from the use of non-recommended lubricants may not be covered by warranty.

WARRANTY

Exported Vehicles

EXCEPT WHERE SPECIFICALLY REQUIRED BY LAW, THERE IS NO WARRANTY OR SERVICE BULLETIN COVERAGE ON THIS VEHICLE IF IT IS SOLD OUTSIDE THE COUNTRY OF THE SELLING DEALER'S AUTHORIZED LOCATION.

This policy does not apply to vehicles that have received authorization for export from Polaris Industries. Dealers may not give authorization for export. You should consult an authorized dealer to determine this vehicle's warranty or service bulletin coverage if you have any questions.

This policy does not apply to vehicles registered to government officials or military personnel on assignment outside the country of the selling dealer's authorized location.

This policy does not apply to Safety Recalls.

How to Get Service

In the Country where your vehicle was purchased:

Warranty or Service Bulletin repairs must be done by an authorized Polaris dealer. If you move or are traveling within the country where your vehicle was purchased, Warranty or Service Bulletin repairs may be requested from any authorized Polaris dealer who sells the same line as your vehicle.

Outside the Country where your vehicle was purchased:

If you are traveling temporarily outside the country where your vehicle was purchased, you should take your vehicle to an authorized Polaris dealer. You must show the dealer photo identification from the country of the selling dealer's authorized location as proof of residence. Upon residence verification, the servicing dealer will be authorized to perform the warranty repair.

If You Move:

If you move to another country, be sure to contact Polaris Customer Assistance and the customs department of the destination country before you move. Vehicles importation rules vary considerably from country to country. You may be required to present documentation of your move to Polaris Industries in order to continue your warranty coverage. You may also be required to obtain documentation from Polaris Industries in order to register your vehicle in your new country.

WARRANTY

Exported Vehicles

How to Get Service

If Purchased From A Private Party:

If you purchase a Polaris product from a private citizen outside of the country in which the vehicle was originally purchased, all warranty coverage will be denied.

Notice

If your vehicle is registered outside of the country where it was purchased, and you have not followed the procedure set out above, your vehicle will no longer be eligible for warranty or service bulletin coverage of any kind. (Vehicles registered to Government officials or military personnel on assignment outside of the country where the vehicle was purchased will continue to be covered by the basic warranty.)

For questions call Polaris Customer Assistance:

United States: 1-763-417-8650

Canada: 1-204-925-7100

INDEX

A

Accessories	107
ADJUSTMENTS	112-114
Age Restrictions	11
Air Filter Service	93
All Wheel Drive	44
Automatic Transmission	43
Auxiliary Brake	88
AWD	44

B

Battery	104-106
Battery (Conventional)	103
Battery Charging (Sealed)	105-106
Battery Fluid (Conventional)	105
Battery Installation	104
Battery Removal	104
Battery Storage	105
Belt Life	43
Brake Fluid	39, 41
Brake Lever	38
Brake, Auxiliary	41
Brake, Parking	40
Brakes	87-88
Break-In Period	51
Breather Filter	93

C

Camber and Caster	112
Carburetor/Idle RPM	113
Choke	42
Cleaning	107-110
Clutching Charts	
Sportsman 400	121
Sportsman 500	123
Sportsman 600	125
Sportsman 700	127
Cold Weather Operation	54
CONTROLS	36-43
Coolant Level	85
Cooling System	85
Crankcase Emission Control System ..	68

D

Diagnostic Mode, Instrumentation ..	48-49
Driving in Reverse	66
Driving on Slippery Surfaces	59
Driving Over Obstacles	65
Driving Procedures	57
Driving Safely	57-67
Driving Through Water	64

E

Electrical Switches	36
EMISSION CONTROL SYSTEMS ..	68
Engaging Front Gearcase	44
Engine Cooling System	86
Engine Stop Switch	36
Equipment Modifications	15
Exhaust Emission Control System ...	68

F

FEATURES	44-49
Filter Systems	93
Front Gearcase Oil	82
Front Wheel Hub Tightening	92
Fuel Filter	42
Fuel Safety	50
Fuel Tank	42
Fuel Valve	42

G

Gear Selector	43
---------------------	----

H

Handlebars	112
Hauling Cargo	55-56
Headlight Housing Replacement	96
Headlight Lamp Replacement	94
Headlamp (Lower)	
Removal/Installation	97
High Beam Adjustment	95
High Range	101
Hour Meter	47

I

Immersion	99
Instrument Cluster	45-49

J

Jetting Charts	
Sportsman 400	121
Sportsman 500	123
Sportsman 600	125
Sportsman 700	127

K

K-Turn	63
--------------	----

L

Light Switches	38
Lights	94-97
Low Range	101
Lubrication Guide	74-75

INDEX

M

Main Switch	36
MAINTENANCE AND LUBRICATION	69-111
Maintenance Record	73
Making Turns	58
Master Cylinder	39
Mode/Reverse Override Switch	36

N

Noise Emission Control System	68
-------------------------------	----

O

Odometer	47
Oil Change	78
Oil Change (400/500)	78-79
Oil Change (600/700)	80
Oil Check	77
Oil Filter Change	78
Oil, Front Gearcase	82
Oil Pump Priming	79
Oil, Rear Gearcase (600/700)	84
Oil, Transmission (400/500)	81
Oil, Transmission (600/700)	83
OPERATION	50-67
Operator Safety	11-35

P

Parking Brake	40
Parking on an Incline	67
Periodic Maintenance Schedule	69-72
POLARIS PRODUCTS	115
Pre-Ride Inspection	52
Premium 4 Synthetic Lubricant	76
PVT Drying	102
PVT System	101-102

R

Radiator Coolant Level	86
Rear Gearcase Oil (600/700)	84
Rear Spring	112
Reverse Override Switch	36
Rider Information Center	46-49

S

Safe Riding Gear	10
SAFETY	6-35
Safety Decals and Locations	6-9
Safety Training	11
Setting the Parking Brake	40

S

Side Panel Removal	90
Sidehilling	61
Spark Arrestor	100
Spark Plug Removal/Replacement	98
Spark Plugs	98
SPECIFICATIONS	120-127
Starting a Cold Engine	53
Starting a Warm Engine	54
Starting the Engine	53-54
Steering Assembly	89
Stop Switch	36
Storage	107-110
Storage Tips	108-110
Switches	36

T

TABLE OF CONTENTS	5
Tachometer	47
Taillight/Brakelight Lamp Replacement	97
Throttle Cable Freeplay	114
Throttle Lever	37
Tires	91
Toe Alignment	89
Transmission	43
Transmission Oil (400/500)	81
Transmission Oil (600/700)	83
Transporting the ATV	111
Traveling Downhill	62
Traveling Uphill	60
Trip Meter	47
TROUBLESHOOTING	116-119
Turning Around on a Hill	63

U

Spark Arrestor	68
----------------	----

V

VEHICLE IDENTIFICATION NUMBERS	4
Vehicle Immersion	99

W

WARRANTY	128-132
WELCOME	3
Wheel Installation	92
Wheel Nut Torque Specifications	92
Wheel Removal	91