



2004

**Owner's Manual
for
Vehicle Maintenance and Safety**

This Category "S" (Sport) ATV is a high-performance ATV for off-road use only. It is for sport-type recreational and competitive use by operators with advanced skills and substantial experience. Operation is prohibited for anyone under 16 years of age.

**Read this manual carefully!
It contains important safety information.**



POLARIS
The Way Out.

⚠ WARNING

**Improper vehicle use can result in
SEVERE INJURY or DEATH.**



**ALWAYS USE
AN APPROVED
HELMET AND
PROTECTIVE
GEAR**



**NEVER USE
ON PUBLIC
ROADS**



**NEVER CARRY
PASSENGERS**



**NEVER USE
WITH DRUGS
OR ALCOHOL**

**READ OWNER'S MANUAL.
FOLLOW ALL INSTRUCTIONS
AND WARNINGS.**

Part No. 9918783
PRINTED IN USA

NEVER:

- Operate without proper training or instruction.
- Operate on public roads. A collision can occur with another vehicle.
- Operate at speeds too fast for your skills or the conditions.
- Use ALCOHOL or DRUGS before or while operating this vehicle.
- Carry Passengers.

ALWAYS:

- Avoid paved surfaces, which may adversely affect handling and control.
- Use proper RIDING TECHNIQUES to avoid vehicle overturns on hills and rough terrain, and in turns.
- Wear eye protection, helmet and protective apparel.



POLARIS®
The Way Out.

 **WARNING**

The engine exhaust from this product contains chemicals known to cause cancer, birth defects or other reproductive harm.

A card containing important ATV safety information should be attached to the owner's manual on the next page. If you cannot locate this card, or if it has been removed, please call 1-800-342-3764 for assistance.

We've created a web site just for YOU!

- Technical tips
- New product introductions
- Event schedules
- Parts and Service Manual information
- Exciting details about The Way Out

Check it out...

www.polarisindustries.com/owner



Polaris, Polaris The Way Out, and Workmobiles are registered trademarks of Polaris Industries Inc.

Copyright 2003 Polaris Sales Inc. All information contained within this publication is based on the latest product information at the time of publication. Due to constant improvements in the design and quality of production components, some minor discrepancies may result between the actual vehicle and the information presented in this publication. Depictions and/or procedures in this publication are intended for reference use only. No liability can be accepted for omissions or inaccuracies. Any reprinting or reuse of the depictions and/or procedures contained within, whether whole or in part, is expressly prohibited. Printed in U.S.A.

WELCOME

Thank you for purchasing a Polaris vehicle, and welcome to our world-wide family of Polaris owners. We proudly produce an exciting line of utility and recreational products.

Polaris Recreational Vehicles

- Snowmobiles
- All-terrain vehicles (ATVs)
- Personal watercraft
- *RANGER* utility vehicles
- Victory motorcycles

Polaris Professional Series Workmobiles™

- Utility Task Vehicles™ (UTVs)
- Personal Task Vehicles™ (PTVs)
- All-Surface Loaders (ASLs)

WELCOME

We believe Polaris sets a standard of excellence for all utility and recreational vehicles manufactured in the world today. Many years of experience have gone into the engineering, design, and development of your Polaris vehicle, making it the finest machine we've ever produced.

For safe and enjoyable operation of your vehicle, be sure to follow the instructions and recommendations in this owner's manual. Your manual contains instructions for minor maintenance, but information about major repairs is outlined in the Polaris Service Manual and should be performed only by a Factory Certified Master Service Dealer (MSD) Technician. Your Polaris dealer knows your vehicle best and is interested in your total satisfaction. Be sure to return to your dealership for all of your service needs during, and after, the warranty period.

We also take great pride in our Parts Apparel and Accessories (PAA) products, available through our online store at www.purepolaris.com. Have your accessories and clothing delivered right to your door!

TABLE OF CONTENTS

WELCOME	3
VEHICLE IDENTIFICATION NUMBERS	6
SAFETY	8
FEATURES AND CONTROLS	52
OPERATION	69
EMISSION CONTROL SYSTEMS	89
MAINTENANCE AND LUBRICATION	91
ADJUSTMENTS	142
CLEANING AND STORAGE	160
TROUBLESHOOTING	167
POLARIS PRODUCTS	175
SPECIFICATIONS	176
WARRANTY	178
INDEX	185

VEHICLE IDENTIFICATION NUMBERS

The frame vehicle identification number (VIN)(1) and engine serial number (2) are important for model identification when registering your vehicle, when obtaining insurance, and when ordering replacement parts. In the event your vehicle is stolen, these numbers are essential to the recovery and identification of your vehicle.

Remove the spare key and store it in a safe place. Your key can be duplicated only by mating a Polaris key blank with one of your existing keys. If both keys are lost, the ignition switch must be replaced. See your Polaris dealer.

NOTE: Record your vehicle's ID numbers and key number (3) in the spaces provided.

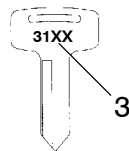
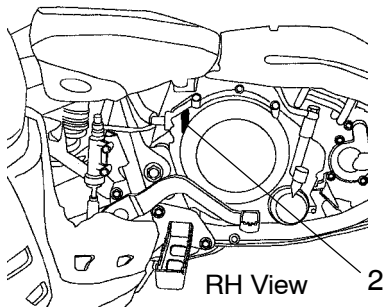
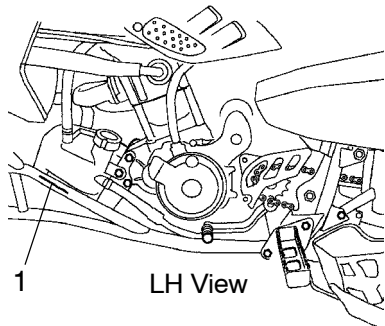

VEHICLE IDENTIFICATION NUMBERS

Frame VIN:

Vehicle Model Number:

Engine Serial Number:

Key Number:

SAFETY

Safety Decals and Locations

Warning decals have been placed on the ATV for your protection. Read and follow the instructions of the decals on the ATV carefully. If any of the decals depicted in this manual differ from the decals on your ATV, always read and follow the instructions of the decals *on the ATV*.

If any decal becomes illegible or comes off, contact your Polaris dealer to purchase a replacement.

Replacement *safety* decals are provided by Polaris at no charge. The part number is printed on the decal.

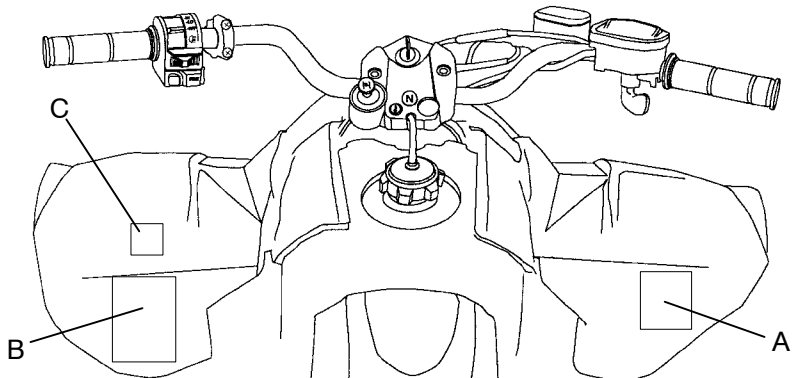

Safety Decals and Locations

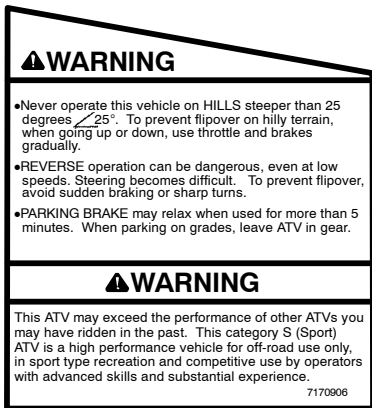

Location A



Location B



Location C

SAFETY

Safety Decals and Locations

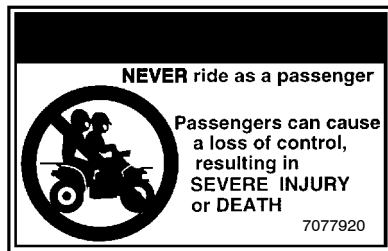
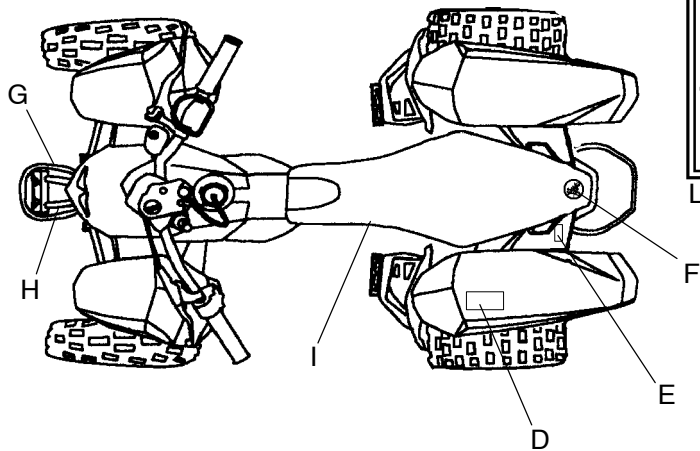

Location E



Location F

Safety Decals and Locations

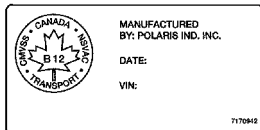

Location G

ATTENTION	
<ul style="list-style-type: none"> • Operation of this vehicle without the air filter element will severely damage the engine. • Clean pre-filter element often, more frequent cleaning required in dusty conditions. Do not operate vehicle without pre-filter. • Operation of this vehicle without engine breather filter(s) can cause engine damage. Consult owner's manual or dealer for details. 	<ul style="list-style-type: none"> • Specific carburetor jetting and adjustments are required depending on temperature and altitude. See your Owner's Manual. <p>Factory setting: 40° to 80° F. at 0-3000 feet (5° to 27° C. at 0-900 meters). 7079902</p>

Location I (under seat)

WARNING

IMPROPER TIRE PRESSURE OR OVERLOADING can cause loss of control resulting in SEVERE INJURY OR DEATH.

TIRE PRESSURE IN PSI (KPa): FRONT 4 (27,6) REAR 4 (27,6)

MAXIMUM WEIGHT CAPACITY (Gross Vehicle Weight) INCLUDING MACHINE, DRIVER AND CARGO IS 645 LBS. (293 kg).

Reduce speed and allow greater distance for braking when carrying cargo. Overloading or carrying tall, off-center, or unsecured loads will increase your risk of losing control. For stability on rough or hilly terrain, reduce speed and cargo.

Read Owner's Manual for more detailed loading information. 7171022

Location D

THIS VEHICLE IS AN ALL TERRAIN VEHICLE AND IS NOT INTENDED FOR USE ON PUBLIC ROADS.

CE VÉHICULE EST UN VÉHICULE TOUT TERRAIN QUI NEST PAS DESTINE A

CE

ETRE UTILISE SUR LES CHEMINS PUBLICS.

7170983

Location H

SAFETY

Safe Riding Gear

Always wear clothing suited to the type of riding. ATV riding requires special protective clothing for comfort and to reduce the chance of injury.

1. Helmet

Your helmet is the most important piece of protective gear for safe riding. A helmet can prevent a severe head injury.

Select an approved helmet that meets or exceeds your state's safety standards and bears either the Department of Transportation (DOT) label, the American National Standards Institute label (ANSI z90.1), or the Snell Memorial Foundation label.

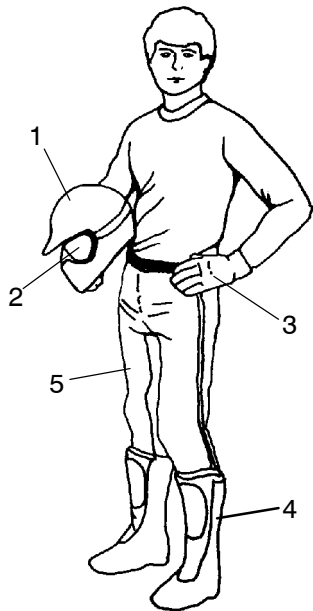

Safe Riding Gear

2. Eye Protection

Do not depend on sunglasses for proper eye protection. A pair of goggles or a helmet face shield offer the best protection for your eyes. They should be kept clean and be of shatterproof design (bearing the markings z2.1 or VESC 8).

3. Gloves

Off-road style gloves with knuckle pads are the best for comfort and protection.

4. Boots

The best footwear is a pair of strong over-the-calf boots with heels, like moto-cross boots.

5. Clothing

Always wear long sleeves and long pants to protect arms and legs. Riding pants with kneepads and a jersey with shoulder pads provide the best protection.

SAFETY

Operator Safety

WARNING

Failure to follow the warnings contained in this manual can result in severe injury or death.

A Polaris ATV is not a toy and can be hazardous to operate. This vehicle handles differently than other vehicles. A collision or rollover can occur quickly, even during routine maneuvers like turning, or driving on hills or over obstacles, if you fail to take proper precautions. Read and understand your owner's manual and all warnings before operating your Polaris ATV.

Operator Restrictions

This vehicle is an **ADULT VEHICLE ONLY**. Operation is prohibited for anyone under 16 years of age. This category S (Sport) ATV is a high performance vehicle intended for off road use only, for sport-type recreation and for competitive use by operators with advanced skills and substantial experience.

Operator Safety

Know Your Vehicle

As the operator of the ATV, you are responsible for your safety, the safety of others, and the protection of our environment. Read and understand your owner's manual, which includes valuable information about all aspects of your ATV, including safe operating procedures.

Safety Training

When you purchased your new Polaris ATV, your dealer offered a hands-on safety training course covering all aspects of vehicle safety. You were also provided with printed materials that explain safe operating procedures, which you should review on a regular basis. If your model is recommended for use by experienced operators only, you also received a safety video. Be sure to view it before operating the ATV.

If you purchased a used Polaris ATV from a party other than a Polaris dealer, you can request this free safety training from any authorized Polaris dealer.

A Polaris ATV is an off-road vehicle. Familiarize yourself with all laws and regulations concerning the operation of this vehicle in your area.

Follow the recommended maintenance program outlined in your owner's manual. This program is designed to ensure that all critical components on the ATV are thoroughly inspected at specific intervals.

SAFETY

Operator Safety

The following two pages identify signal words and symbols that appear in this manual. Your safety is involved when these words and symbols are used. Become familiar with their meanings before reading the manual.



The *safety alert symbol*, on your vehicle or in this manual, alerts you to the potential for personal injury.

WARNING

The *safety alert warning* indicates a potential hazard that may result in serious injury or death.

Operator Safety

CAUTION

The *safety alert caution* indicates a potential hazard that may result in minor personal injury or damage to the vehicle.

CAUTION

A *caution* indicates a situation that may result in damage to the vehicle.

NOTE:

A *note* will alert you to important information or instructions.

SAFETY

Operator Safety

WARNING

Serious injury or death can result if you do not follow these instructions and procedures, which are outlined in further detail within your owner's manual.

- Read this manual and all labels carefully, and follow the operating procedures described.
- Never operate an ATV without proper instruction. *Take a training course.* Beginners should receive training from a certified instructor. Contact an authorized Polaris ATV dealer or call Polaris at 1-800-342-3764 to find out about the training courses nearest you.
- Never allow anyone under 16 years of age to operate this ATV.
- Never permit a guest to operate the ATV unless the guest has read this manual and all product labels and has completed a certified safety training course.
- Always avoid operating an ATV on paved surfaces, including sidewalks, driveways, parking lots, and streets.

Operator Safety

- Never operate an ATV on a public street, road or highway, including a dirt or gravel road.
- Never operate an ATV without wearing an approved helmet that fits properly. Always wear eye protection (goggles or face shield), gloves, boots, a long-sleeved shirt or jacket, and long pants.
- Never consume alcohol or drugs before or while operating an ATV.
- Never operate at excessive speeds. Travel at speeds appropriate for the terrain, visibility and operating conditions, and your experience.
- Never attempt wheelies, jumps or other stunts.
- Always inspect your ATV before each use to make sure it's in safe operating condition. Always follow the inspection and maintenance procedures and schedules outlined in your owner's manual.
- Always keep both hands on the handlebars and both feet on the footpegs of the ATV during operation.
- Always travel slowly and use extra caution when operating on unfamiliar terrain. Be alert to changing terrain conditions.

SAFETY

Operator Safety

- Never operate on excessively rough, slippery, or loose terrain.
- Always follow proper turning procedures as described in this manual. Practice turning at low speeds before attempting to turn at faster speeds. Do not turn at excessive speeds.
- Always have the ATV inspected by an authorized Polaris dealer if it's been involved in an accident.
- Never operate on hills too steep for the ATV or for your abilities. Practice on smaller hills before attempting larger hills.
- Always follow proper procedures for climbing hills. Check the terrain carefully before ascending a hill. Never climb hills with excessively slippery or loose surfaces. Shift your weight forward. Never open the throttle suddenly or make sudden gear changes. Never go over the top of a hill at high speed.
- Always follow proper procedures for going downhill and for braking on hills. Check the terrain carefully before you start down a hill. Shift your weight backward. Never go down a hill at high speed. Avoid going down a hill at an angle, which would cause the vehicle to lean sharply to one side. Travel straight down the hill when possible.

Operator Safety

- Always follow proper procedures for crossing the side of a hill. Avoid hills with excessively slippery or loose surfaces. Shift your weight to the uphill side of the ATV. Never attempt to turn the ATV around on any hill until you've mastered (on level ground) the turning technique outlined in this manual. Avoid crossing the side of a steep hill when possible.
- Always use proper procedures if you stall or roll backwards while climbing a hill. To avoid stalling, maintain a steady speed when climbing a hill. If you stall or roll backwards, follow the special procedure for braking described in this manual. Always dismount on the uphill side, or to either side if the ATV is pointed straight uphill. Turn the ATV around and remount following the procedure described in this manual.
- Always check for obstacles before operating in a new area. Never attempt to operate over large obstacles, such as rocks or fallen trees. Always follow proper procedures when operating over obstacles as described in this manual.
- Always be careful of skidding or sliding. On slippery surfaces like ice, travel slowly and use extra caution to reduce the chance of skidding or sliding out of control.

SAFETY

Operator Safety

- Avoid operating the ATV through deep or fast-flowing water. If it's unavoidable, travel slowly, balance your weight carefully, avoid sudden movements, and maintain a slow and steady forward motion. Do not make sudden turns or stops, and do not make sudden throttle changes.
- Wet brakes may have reduced stopping ability. Test the brakes after leaving water. If necessary, apply them lightly several times to allow friction to dry out the pads.
- Always use the size and type of tires specified for your ATV, and always maintain proper tire pressure.
- Never modify an ATV through improper installation or use of accessories.
- Never exceed the stated load capacity for your ATV.

FOR MORE INFORMATION ABOUT ATV SAFETY, call the Consumer Product Safety Commission at 1-800-638-2772, or call Polaris at 1-800-342-3764.

Operator Safety

Equipment Modifications

We are concerned for the safety of our customers and for the general public. Therefore, we strongly recommend that consumers do not install on a Polaris ATV any equipment that may increase the speed or power of the vehicle, or make any other modifications to the vehicle for these purposes. Any modifications to the original equipment of the vehicle create a substantial safety hazard and increase the risk of bodily injury.

The warranty on your Polaris ATV is terminated if any equipment has been added to the vehicle, or if any modifications have been made to the vehicle, that increase its speed or power.

NOTE: The addition of certain accessories may change the handling characteristics of the vehicle. Use only Polaris-approved accessories, and familiarize yourself with their function and effect on the vehicle.

SAFETY

Operator Safety

WARNING

POTENTIAL HAZARD: Operating this ATV without proper instruction.

WHAT CAN HAPPEN: The risk of an accident is greatly increased if the operator does not know how to operate the ATV properly in different situations and on different types of terrain.

HOW TO AVOID THE HAZARD: Beginning and inexperienced operators should complete the certified training course offered by Polaris. Operators should regularly practice the skills learned in the course and the operating techniques described in the owner's manual.

For more information about the training course, contact an authorized ATV dealer or call Polaris at 1-800-342-3764.

Operator Safety

WARNING

POTENTIAL HAZARD: Failure to follow the skill and experience recommendations for this ATV.

WHAT CAN HAPPEN: Severe injury and/or death could occur if a beginner or inexperienced driver operates this ATV.

HOW TO AVOID THE HAZARD: Only operators with advanced skills and substantial experience should operate this ATV.

SAFETY

Operator Safety

WARNING

POTENTIAL HAZARD: Failure to follow the age recommendations for this ATV.

WHAT CAN HAPPEN: Severe injury and/or death could occur if a child under the minimum age recommendation operates this ATV.

Even though a child may be within the recommended age group for operating some ATVs, he/she may not have the skills, abilities, or judgment needed to operate an ATV safely and could be susceptible to accident or injury.

HOW TO AVOID THE HAZARD: No one under the age of 16 should operate a Polaris ATV. Only operators with advanced skills and substantial experience should operate this ATV.

Operator Safety

⚠ WARNING

POTENTIAL HAZARD: Carrying a passenger on an ATV.

WHAT CAN HAPPEN: Carrying a passenger greatly reduces the operator's ability to balance and control the ATV, which could cause an accident and injury to the operator and/or passenger.

HOW TO AVOID THE HAZARD: Never carry a passenger. The purpose of the long seat is to allow the operator to shift position as needed during operation. It is not intended for carrying passengers.

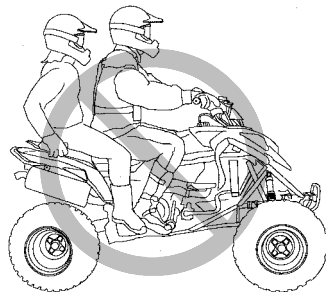

SAFETY

Operator Safety

⚠️ WARNING

POTENTIAL HAZARD: Operating an ATV on paved surfaces, including sidewalks, paths, parking lots, and driveways.

WHAT CAN HAPPEN: ATV tires are designed for off-road use. Operating on paved surfaces may adversely affect the handling of the ATV and could result in loss of control, accident, and/or injury.

HOW TO AVOID THE HAZARD: Avoid operating the ATV on pavement. If it's unavoidable, travel slowly and avoid sudden turns or stops.

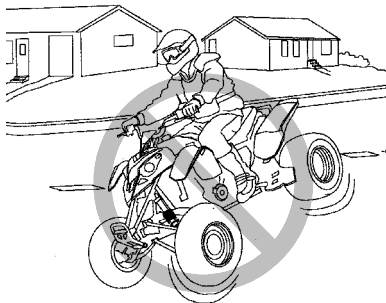

Operator Safety

⚠ WARNING

POTENTIAL HAZARD: Operating this ATV on public streets, roads or highways.

WHAT CAN HAPPEN: The ATV could collide with another vehicle.

HOW TO AVOID THE HAZARD: Never operate the ATV on any public street, road or highway, including dirt and gravel roads. In many states it's illegal to operate ATVs on public streets, roads and highways.

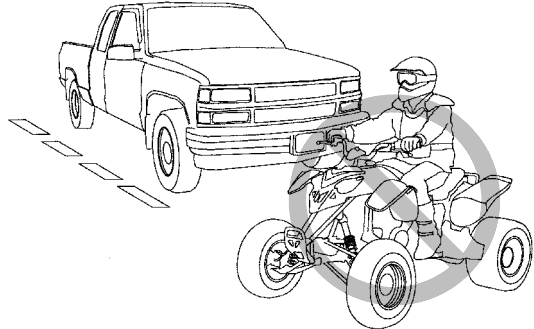

SAFETY

Operator Safety

WARNING

POTENTIAL HAZARD: Operating this ATV without wearing an approved helmet, eye protection and protective clothing.

WHAT CAN HAPPEN: Operating an ATV without an approved helmet increases the risk of a severe head injury or death in the event of an accident.

Operating without eye protection could result in an accident and could increase the chance of a severe injury in the event of an accident.

HOW TO AVOID THE HAZARD: Always wear an approved helmet that fits properly. Always wear eye protection (goggles or face shield), gloves, boots, long-sleeved shirt or jacket, and long pants.

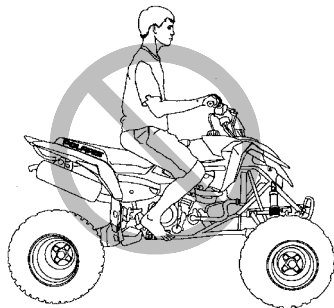

Operator Safety

WARNING

POTENTIAL HAZARD: Operating the ATV after consuming alcohol or drugs.

WHAT CAN HAPPEN: Consumption of alcohol and/or drugs could seriously affect operator judgment. Reaction time may be slower and operator balance and perception could be affected.

Consuming alcohol and/or drugs before or while operating an ATV could result in an accident causing severe injury or death.

HOW TO AVOID THE HAZARD: Never consume alcohol or drugs before or while operating an ATV.

SAFETY

Operator Safety

WARNING

POTENTIAL HAZARD: Operating the ATV at excessive speeds.

WHAT CAN HAPPEN: Excessive speed increases the operator's chance of losing control of the ATV, which can result in an accident causing severe injury or death.

HOW TO AVOID THE HAZARD: Always operate the ATV at a speed that's proper for the terrain, visibility and operating conditions, and your experience.

Operator Safety

⚠ WARNING

POTENTIAL HAZARD: Attempting wheelies, jumps and other stunts.

WHAT CAN HAPPEN: Attempting stunts increases the chance of an accident, including an overturn.

HOW TO AVOID THE HAZARD: Never attempt wheelies, jumps, or other stunts. Avoid exhibition driving.

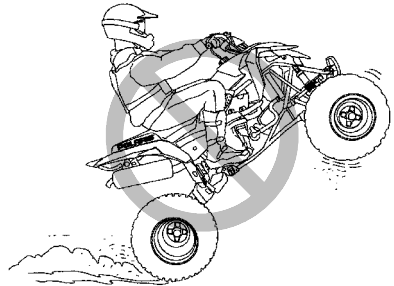

SAFETY

Operator Safety

WARNING

POTENTIAL HAZARD: Failure to inspect the ATV before operating.

Failure to properly maintain the ATV.

WHAT CAN HAPPEN: Poor maintenance increases the possibility of an accident or equipment damage.

HOW TO AVOID THE HAZARD: Always inspect your ATV before each use to make sure it's in safe operating condition. Always follow the inspection and maintenance procedures and schedules described in the owner's manual.

Operator Safety

 **WARNING**

POTENTIAL HAZARD: Removing hands from the handlebars or feet from the footpegs during operation.

WHAT CAN HAPPEN: Removing even one hand or foot can reduce ability to control the vehicle or could cause loss of balance and ejection from the ATV.

If the operator's foot is not firmly planted on the footpeg, it could come into contact with the rear wheels and lead to accident or injury.

HOW TO AVOID THE HAZARD: Always keep both hands on the handlebars and both feet on the footpegs of the ATV during operation.

SAFETY

Operator Safety

WARNING

POTENTIAL HAZARD: Failure to use extra caution when operating the ATV on unfamiliar terrain.

WHAT CAN HAPPEN: Unfamiliar terrain may contain hidden rocks, bumps, or holes that could cause loss of control or overturn.

HOW TO AVOID THE HAZARD: Travel slowly and use extra caution when operating on unfamiliar terrain. Always be alert to changing terrain conditions.

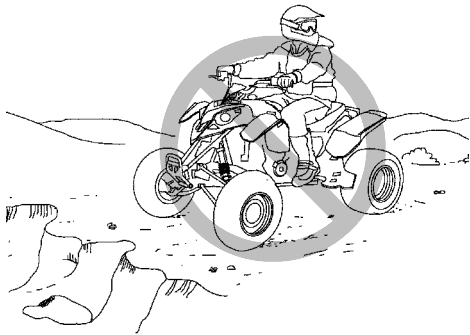

Operator Safety

⚠ WARNING

POTENTIAL HAZARD: Failure to use extra caution when operating on excessively rough, slippery or loose terrain.

WHAT CAN HAPPEN: Operating on excessively rough, slippery or loose terrain could cause loss of traction or loss of control, which could result in an accident or overturn.

HOW TO AVOID THE HAZARD: Do not operate on excessively rough, slippery or loose terrain until you've learned and practiced the skills necessary to control the ATV on such terrain. Always use extra caution on rough, slippery or loose terrain.

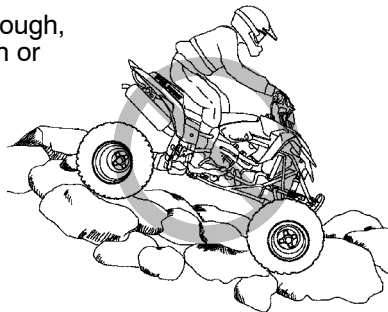

SAFETY

Operator Safety

WARNING

POTENTIAL HAZARD: Turning improperly.

WHAT CAN HAPPEN: Improper turns could cause loss of control and lead to a collision or overturn.

HOW TO AVOID THE HAZARD: Always follow proper procedures for turning as described in the owner's manual. Practice turning at slow speeds before attempting to turn at faster speeds. Never turn at excessive speed.

Operator Safety

 **WARNING**

POTENTIAL HAZARD: Operating on excessively steep hills.

WHAT CAN HAPPEN: The vehicle may overturn.

HOW TO AVOID THE HAZARD: Never operate on hills too steep for the ATV or for your abilities. Never operate the ATV on hills steeper than 25 degrees  25°. Practice on smaller hills before attempting large hills.

SAFETY

Operator Safety

WARNING

POTENTIAL HAZARD: Climbing hills improperly.

WHAT CAN HAPPEN: Improper hill climbing could cause loss of control or overturn.

HOW TO AVOID THE HAZARD: Always follow proper procedures for climbing hills as described in the owner's manual. Always check the terrain carefully before ascending any hill. Never operate the ATV on hills steeper than 25°. Never climb hills with excessively slippery or loose surfaces. Shift your weight forward. Never open the throttle suddenly while traveling uphill. The ATV could flip over backwards. Never go over the top of any hill at high speed. An obstacle, a sharp drop, or another vehicle or person could be on the other side of the hill.

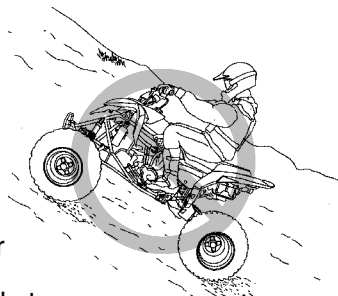

Operator Safety

⚠ WARNING

POTENTIAL HAZARD: Traveling downhill improperly.

WHAT CAN HAPPEN: Improperly descending a hill could cause loss of control or overturn.

HOW TO AVOID THE HAZARD: Always follow proper procedures for traveling down hills as described in the owner's manual. **NOTE:** A special technique is required when braking while traveling downhill. See page 84. Always check the terrain carefully before descending a hill. Shift your weight backward. Never travel down a hill at high speed. Avoid traveling down a hill at an angle, which would cause the vehicle to lean sharply to one side. Travel straight down the hill when possible.

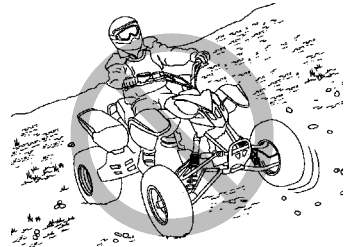

SAFETY

Operator Safety

⚠️ WARNING

POTENTIAL HAZARD: Improperly crossing hills and turning on hills.

WHAT CAN HAPPEN: Improperly crossing or turning as hills could cause loss of control or overturn.

HOW TO AVOID THE HAZARD: Never attempt to turn the ATV around on any hill until you've mastered the turning technique (on level ground) as described in the owner's manual. See page 82. Use extra caution when turning on any hill. Avoid crossing the side of a steep hill.

When crossing the side of a hill:

Always follow proper procedures as described in the owner's manual. Avoid hills with excessively slippery or loose surfaces. Shift your weight to the uphill side of the ATV.



Operator Safety

⚠ WARNING

POTENTIAL HAZARD: Stalling, rolling or improperly dismounting while climbing a hill.

WHAT CAN HAPPEN: The vehicle could overturn.

HOW TO AVOID THE HAZARD: Maintain steady speed when climbing a hill.

If all forward speed is lost: Keep your weight uphill. Apply front brakes gradually. When fully stopped, apply rear brake as well, then lock the parking brake.

If the ATV begins rolling backwards: Keep weight uphill. Never apply engine power. Never apply the rear brake while rolling backwards. Apply the front brake gradually. When fully stopped, apply the rear brake as well, and then lock the parking brake. Dismount on uphill side, or to either side if ATV is pointed straight uphill. Turn the ATV around and remount, following the procedure described in the owner's manual. See page 82.

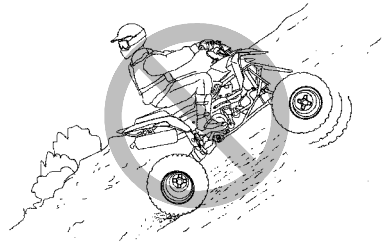

SAFETY

Operator Safety

WARNING

POTENTIAL HAZARD: Improperly operating over obstacles.

WHAT CAN HAPPEN: Operating over obstacles could cause loss of control or overturn.

HOW TO AVOID THE HAZARD: Before operating in a new area, check for obstacles. Avoid operating over large obstacles such as rocks and fallen trees when possible. If unavoidable, use extreme caution and always follow proper procedures as outlined in the owner's manual.

Operator Safety

WARNING

POTENTIAL HAZARD: Skidding or sliding.

WHAT CAN HAPPEN: Skidding or sliding can cause loss of control. If the tires regain traction unexpectedly, the ATV could overturn.

HOW TO AVOID THE HAZARD: On slippery surfaces such as ice, travel slowly and use extra caution to reduce the chance of skidding or sliding out of control.

SAFETY

Operator Safety

WARNING

POTENTIAL HAZARD: Operating the ATV through deep or fast-flowing water.

WHAT CAN HAPPEN: Tires may float, causing loss of traction and loss of control, which could lead to an accident or overturn.

HOW TO AVOID THE HAZARD: Avoid operating the ATV through deep or fast-flowing water. If it's unavoidable to enter water that exceeds the recommended maximum depth (see page 87), travel slowly, balance your weight carefully, avoid sudden movements, and maintain a slow and steady forward motion. Do not make sudden turns or stops, and do not make sudden throttle changes.

Wet brakes may have reduced stopping ability. Always test the brakes after leaving water. If necessary, apply them several times to let friction dry out the pads.

Operator Safety

 **WARNING**

POTENTIAL HAZARD: Operating this ATV with improper tires, or with improper or uneven tire pressure.

WHAT CAN HAPPEN: Use of improper tires, or operation of the ATV with improper or uneven tire pressure, could cause loss of control or accident.

HOW TO AVOID THE HAZARD: Always use the size and type of tires specified for the ATV in the owner's manual. Always maintain proper tire pressure as described in the owner's manual and on safety decals.

SAFETY

Operator Safety

WARNING

POTENTIAL HAZARD: Operating the ATV with improper modifications.

WHAT CAN HAPPEN: Improper installation of accessories or modification of the ATV may cause changes in handling, which could lead to an accident.

HOW TO AVOID THE HAZARD: Never modify the ATV through improper installation or use of accessories. All parts and accessories added to the vehicle must be genuine Polaris Industries Inc. or equivalent components designed for use on this ATV and should be installed and used according to approved instructions. See your authorized Polaris ATV dealer for more information.

Operator Safety

WARNING

POTENTIAL HAZARD: Overloading the ATV or carrying/towing cargo.

WHAT CAN HAPPEN: Overloading or carrying/towing cargo can cause changes in vehicle handling, which could lead to loss of control or an accident.

HOW TO AVOID THE HAZARD: Never haul cargo or tow a load with this ATV. Never exceed the stated load capacity for this ATV.

SAFETY

Operator Safety

WARNING

POTENTIAL HAZARD: Operating on frozen bodies of water.

WHAT CAN HAPPEN: Severe injury or death can result if the ATV and/or the operator fall through the ice.

HOW TO AVOID THE HAZARD: Never operate the ATV on a frozen body of water.

Operator Safety

WARNING

Operating a damaged ATV can result in an accident with serious injury or death. After any overturn or accident, have a qualified service dealer inspect the entire machine for possible damage, including (but not limited to) brakes, throttle and steering systems.

WARNING

Safe operation of this rider-active vehicle requires good judgement and physical skills. Persons with cognitive or physical disabilities who operate this vehicle have an increased risk of overturn and loss of control, which could result in severe injury or death.

CAUTION

Exposure to the hot components could result in a fire. Always keep combustible materials away from the exhaust system.

FEATURES AND CONTROLS

Engine Electrical Switches

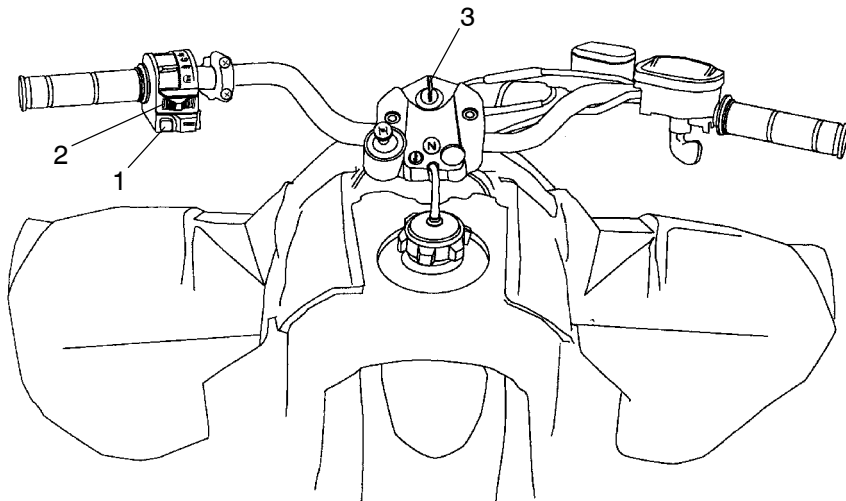

FEATURES AND CONTROLS

Engine Electrical Switches

1. **Start Button** - The start button engages the starter. Always release the start button as soon as the engine starts.
2. **Engine Stop Switch** - The purpose of this switch is to provide the operator with a quick means of engine shutdown in case of an emergency. The engine will not start or run when the switch is in the *OFF* position.
3. **Main Key Switch** - To start the engine, the main key switch must be in the *RUN* position.

NOTE: Both the main switch and the emergency engine stop switch will shut off all electrical power to the vehicle, including lights. To stop the engine quickly, slide the stop switch either right or left to the *OFF* position.

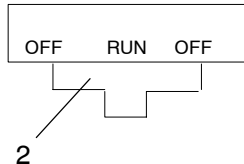

FEATURES AND CONTROLS

Lights

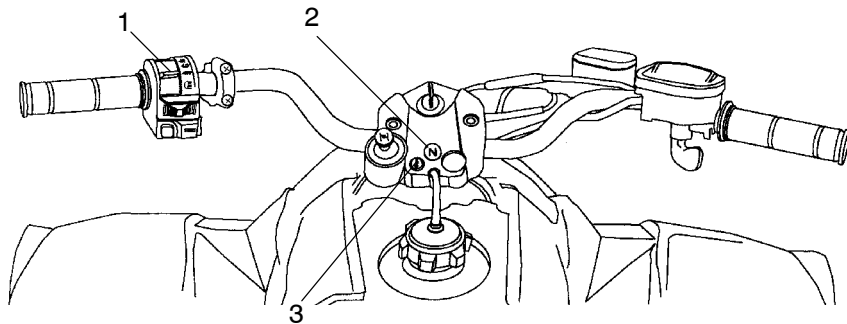

1. Headlight HI/LO Switch
2. Neutral Indicator Lamp
3. High Temp Indicator Lamp

FEATURES AND CONTROLS

Light Switches

The light switch is located on the left handlebar. It's used to turn the lights on and off and to switch the lights from HI to LO. **NOTE:** The lights won't work unless the key is in the *ON* position and the engine stop switch is in the *RUN* position.

WARNING

Operating the ATV on streets or roads, especially in darkness, could result in an accident and serious injury or death.

Your ATV is not equipped with highway-approved lights. It's designed for and must be used for *off-road use only*. Use caution and drive at reduced speeds in conditions of reduced visibility such as fog, rain and darkness.

FEATURES AND CONTROLS

⚠ WARNING

Operating an ATV with sticking or improperly operating throttle controls could cause an accident and lead to severe injury or death.

Never start or operate an ATV with a sticking or improperly operating throttle. Always contact your dealer for service if throttle problems arise.

Failure to check or maintain proper operation of the throttle system can result in an accident if the throttle lever sticks during operation. Always check the lever for free movement and return before starting the engine. Also check occasionally during operation.

Throttle Lever

Engine speed and vehicle movement are controlled by pressing the throttle lever (1) toward the handlebar. The throttle lever is spring loaded. Engine speed returns to idle and the ATV will slow down when the lever is released.

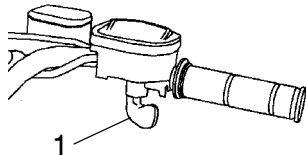

FEATURES AND CONTROLS

Electronic Throttle Control

This ATV is equipped with Polaris Electronic Throttle Control (ETC), which is designed to reduce the risk of a frozen or stuck throttle. If the throttle cable should stick in an open position when the operator releases the throttle lever, the engine will stop, and power to the rear wheels will cease.

⚠️ WARNING

The Electronic Throttle Control (ETC) stops the engine in the event of a throttle system malfunction and is provided for your safety. Do not attempt to modify the ETC system or replace it with any after market throttle mechanisms.

Clutch Lever

The clutch lever (1) is located on the left-hand handlebar. Squeeze the clutch lever toward the handlebar to disengage the clutch. *Disengage the clutch before shifting gears.*

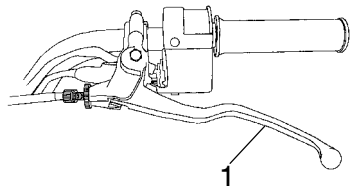

FEATURES AND CONTROLS

Foot Brake

Your Polaris ATV has a foot pedal (1) that activates the rear brakes. It's located in front of the right-hand footpeg (2) and is operated by the right foot.

If the rear wheels slide while using the foot brake, *reduce* brake pedal pressure to brake the wheels without skidding.

Check the brake fluid level frequently for the foot brake system. The reservoir is located behind the right side panel. Maintain the fluid level between the MIN and MAX marks.

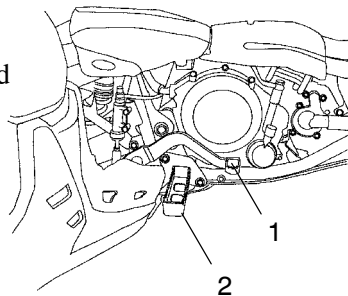

WARNING

Aggressively applying the foot brake when backing down a hill may cause rear tipover, which could result in serious injury or death.

Use caution when applying the foot brake. Do not aggressively apply the foot brake when going forward. The rear wheels may skid and slide sideways, causing loss of control and serious injury or death.

FEATURES AND CONTROLS

Brake Lever

The Predator ATV has a single brake lever for the front brakes. It's located on the right handlebar. The front brakes are applied by squeezing the brake lever (1) toward the handlebar. The front brakes are hydraulically activated disc type brakes.

Always test brake lever travel and master cylinder fluid level before riding. When squeezed, the lever should feel firm. Any sponginess would indicate a possible fluid leak or low master cylinder fluid level, which must be corrected before riding. Contact your dealer for proper diagnosis and repairs.

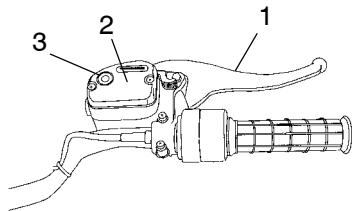

⚠️ WARNING

Operating the ATV with a spongy brake lever can result in loss of braking, which could cause an accident. Never operate the ATV with a spongy-feeling brake lever.

FEATURES AND CONTROLS

Master Cylinder

The master cylinder (2) is located on the right-hand handlebar. The brake fluid level should be checked before each ride. The fluid level can be seen through the indicator window (3) on the top of the master cylinder. This *eye* will appear dark when the fluid level is full. When fluid needs to be added, the eye will be clear.

NOTE: When checking the fluid level, the ATV must be on level ground with the handlebars straight. If the fluid level is low add DOT 3 brake fluid only. Do not overfill. See page 175 for the part numbers of Polaris products.

WARNING

Overfilling the master cylinder will result in brake failure. Without room to expand, the excess fluid will cause the brakes to apply automatically, which could result in serious injury or death. Always maintain the fluid level between the MIN and MAX marks.

After opening a bottle of brake fluid, always discard any unused portion. Never store or use a partial bottle. Brake fluid is hygroscopic, meaning it rapidly absorbs moisture from the air. The moisture causes the boiling temperature of the brake fluid to drop, which can lead to early brake fade and the possibility of accident or severe injury. See page 142.

FEATURES AND CONTROLS

Parking Brake

WARNING

Operating the ATV while the parking brake is engaged could result in an accident and serious injury or death. Always check to be sure the parking brake is disengaged before operating.

Setting the Parking Brake

1. Place the transmission in first gear or neutral.
2. Squeeze and release the brake lever (1) two or three times, then squeeze and hold.
3. Push the park brake lock (2) forward to engage the lock. Release the brake lever.
4. To release the parking brake lock, squeeze and release the brake lever. It will return to its unlocked position.

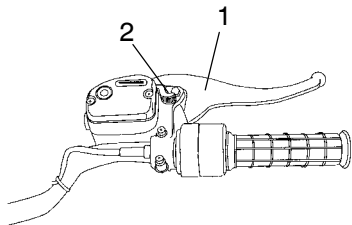

FEATURES AND CONTROLS

Parking Brake

Important Safeguards

- The parking brake may relax if left on for a long period of time. Always block the wheels to prevent rolling.
- Always block the wheels on the downhill side of the ATV if leaving it parked on a hill. Another option is to park the ATV in a sidehill position.
- Never depend on the parking brake alone if the ATV is parked on a hill. Always block the wheels to prevent rolling.
- Place the transmission in first gear or neutral before locking the park brake.

FEATURES AND CONTROLS

Fuel Valve

The fuel valve (1) is located under the fuel tank on the left side of the ATV. It has three positions:

OFF: For vehicle storage and when transporting.

ON: For normal operation.

RES: For reserve supply if main supply is exhausted.

NOTE: There's about a 5 to 8 mile (8 to 13 km) range on reserve gas. Always refill the gas tank as soon as possible after using the main supply.

Always return the valve to the *ON* position after refueling.

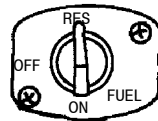
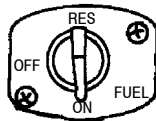
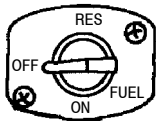
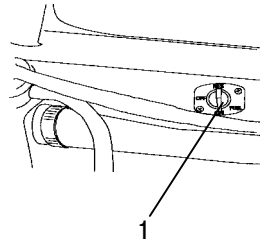

FEATURES AND CONTROLS

Fuel Tank

The fuel tank filler cap is located directly below the handlebar. Use either leaded or unleaded gasoline with a minimum pump octane number of $87=(R+ M/2)$ octane.

Fuel Filter

The fuel valve has an internal fuel filter. Do not attempt to clean the fuel filter. See your Polaris dealer for service if you suspect the fuel filter is plugged.

Choke

The choke assists in starting a cold engine. Refer to the engine starting procedure on page 74 for correct choke and throttle settings during starting. The choke is fully on when the choke knob (1) is pulled completely out. The choke is off when the knob is pushed completely in.

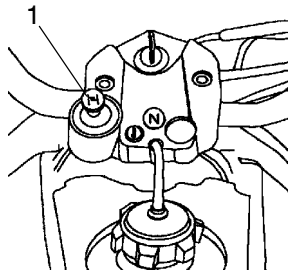

FEATURES AND CONTROLS

Manual Shift

Shift Pedal

The gear shift pedal is located in front of the left-hand footpeg. One full stroke of the pedal shifts the transmission to the next gear in the shifting sequence. The pedal automatically returns to a horizontal position when released.

To upshift to a higher gear, place the toe of your boot under the gear shift pedal and raise the pedal one full stroke. To downshift, place your foot on the gear shift pedal and depress the pedal one full stroke. See page 67.

⚠️ WARNING

Shifting without releasing the throttle and disengaging the clutch could cause loss of control or vehicle overturn. Always release the throttle and fully squeeze the clutch lever while shifting gears.

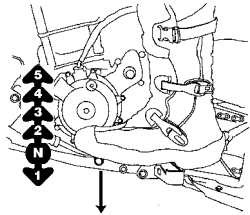
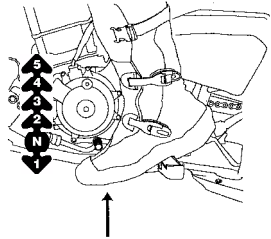

FEATURES AND CONTROLS

Manual Shift

The engine can be started when the transmission is in neutral, or while in gear if the clutch is disengaged.

Place the stop switch in the *RUN* position, then turn the key to *ON*.

If starting while in neutral, the neutral indicator light should be on. If it isn't, disengage the clutch (squeeze the clutch lever fully) and shift the foot pedal to find neutral. See page 65.

When the vehicle is in neutral, press the start button to start the engine.

If starting the engine while in gear:

1. Apply the hand brake.
2. Squeeze the clutch lever fully to disengage the clutch.
3. Press the start button to start the engine. Release the start button immediately when the engine starts.

FEATURES AND CONTROLS

Manual Shift

Shifting Gears

NOTE: Always allow the engine to warm up before shifting gears.

1. When starting from a stopped position with the transmission in neutral, squeeze and hold the brake lever.
2. With the throttle closed (not depressed), squeeze the clutch lever to disengage the clutch. Depress the gear shift pedal one full stroke to shift into first gear.
3. Release the brake lever. Increase engine speed by gradually opening the throttle (squeezing the throttle lever) while slowly releasing the clutch lever.
4. As engine speed (RPM) increases in first gear, simultaneously release the throttle, disengage the clutch and shift to second gear by raising the gear shift pedal one full stroke. Repeat this procedure to progressively upshift to additional gears.
5. Use the same procedure to downshift.

FEATURES AND CONTROLS

Manual Shift

Deceleration

To slow or stop the ATV, release the throttle lever and apply the brakes smoothly and evenly. As the vehicle slows and engine RPM decreases, disengage the clutch and shift to a lower gear. **NOTE:** Be sure the engine RPM has sufficiently decreased before shifting to a lower gear.

WARNING

Improper use of the brakes, or shifting when the engine RPM is too high can cause the tires to lose traction or stop rotating, which could lead to loss of control, accident, and injury. It could also cause engine or drive train damage.

Make sure the engine RPM has sufficiently decreased before shifting to a lower gear.

Fuel Safety

WARNING

Gasoline is highly flammable and explosive under certain conditions.

- Always exercise extreme caution whenever handling gasoline.
- Always refuel with the engine stopped, and outdoors or in a well ventilated area.
- Do not smoke or allow open flames or sparks in or near the area where refueling is performed or where gasoline is stored.
- Do not overfill the tank. Do not fill the tank neck.
- If gasoline spills on your skin or clothing, immediately wash it off with soap and water and change clothing.
- Never start the engine or let it run in an enclosed area. Engine exhaust fumes are poisonous and can cause loss of consciousness or death in a short time.
- Turn the fuel valve off whenever the ATV is stored or parked.
- Make sure the vent line is in good condition and is routed properly.

OPERATION

Break-In Period

Careful treatment of a new engine and transmission will result in more efficient performance and longer life for both. The break-in period for your new Polaris Predator is defined as the first one hour of operation (followed by an additional two hours of cautious operation), or the time it takes to use the first full tank of gasoline. No single action on your part is as important as following the procedures for a proper break-in. Perform the following procedures carefully.

CAUTION

Excessive heat build-up during the first three hours of operation may damage close-fitted engine and transmission parts. Do not operate at full throttle or high speeds for extended periods during the first three hours of use.

Use of any lubricants other than those recommended by Polaris may cause serious engine damage. We recommend the use of Polaris lubricants for your vehicle.

Break-In Period

1. Fill the fuel tank with gasoline. See page 64.
2. Check the oil level on the dipstick. See page 105. Add oil if necessary to maintain the level between the safe and add marks.
3. Allow the engine sufficient time to warm up before operating.
4. Drive slowly at first. Select an open area that allows room to familiarize yourself with vehicle operation and handling.
5. Vary the throttle positions. Do not operate at sustained idle.
6. Perform regular checks on fluid levels, controls and areas outlined on the daily pre-ride inspection checklist. See page 72.
7. During the break-in period, change both the oil and the filter after one hour of operation, or after using the first tank of fuel.

OPERATION

Pre-Ride Inspection

WARNING

If a proper inspection is not done before each use, severe injury or death could result. Always inspect the vehicle before each use to ensure it's in proper operating condition.

Use the following checklist to verify that your vehicle is in proper working condition before each use.

Item/Inspection Procedure

1. Fuel tank and engine oil level - Fill both to their proper levels. See page 105.
2. Engine coolant - Check for proper level at the recovery bottle. See page 115.
3. All brakes - Check operation, adjustment and fluid levels (includes foot brake). See page 143.
4. Clutch Lever - Check for proper operation and correct adjustment. See page 155.

Pre-Ride Inspection

5. Throttle - Check for free operation and closing. See page 156.
6. Steering - Check for free operation, noting any unusual looseness in any area.
7. Headlight/Taillight/Brakelight - Check operation of all indicator lights and switches.
8. Engine stop switch - Check for proper function.
9. Air cleaner element - Check for dirt; clean or replace.
10. Tires - Check condition and pressures.
11. Wheels - Check for tightness of wheel nuts and axle nuts. Check that axle nuts are secured by cotter pins.
12. A-arm ball joints - Check freeplay. If the tire moves excessively, see your Polaris dealer for replacement before operating.
13. Loose parts - Visually inspect the vehicle for any damaged components or loose nuts/bolts or fasteners.
14. Riding gear - Wear a helmet, goggles and protective clothing.

OPERATION

Starting a Cold Engine

⚠️ WARNING

Engine exhaust contains poisonous carbon monoxide and can cause loss of consciousness resulting in severe injury or death. Never run an engine in an enclosed area.

CAUTION

Operating the vehicle immediately after starting could cause engine damage. Allow the engine to warm up for several minutes before operating.

1. Place the transmission in neutral, lock the parking brake and disengage the clutch. Make sure the fuel valve is on.
2. Sit on the ATV and pull the choke knob (1) out until it stops. **NOTE:** If the knob doesn't stay where positioned, increase the tension by rotating the tension adjusting nut clockwise.

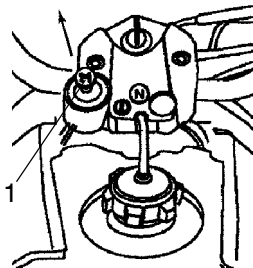

Starting a Cold Engine

NOTE: The variable choke is fully on when the knob is pulled completely out. The choke is off when the knob is pushed completely in. The choke can be adjusted gradually, depending on how much choke is needed for starting. Be sure the choke is off during operation, as excess fuel washing into the engine oil will increase wear on engine components.

3. Move the engine stop switch to the *RUN* position. **NOTE:** Do not press the throttle lever while starting the engine.
4. Turn the ignition key to the *ON* position and press the start button to engage the starter. Activate the starter for a maximum of five seconds, releasing the button when the vehicle starts. **NOTE:** Excessive engagement may result in starter damage.
5. If the engine does not start, wait five seconds after releasing the start button, then activate the starter for another five seconds. Repeat until the engine starts.
6. If the engine slows or stops, position the choke knob half way in to allow proper engine warm-up.
7. Vary the engine RPM slightly with the throttle to aid in warm-up. When the engine idles smoothly, push the choke completely in.

OPERATION

Starting a Warm Engine

Warm engines do not normally require the use of the choke. Excessive use of the choke can cause the spark plug to become wet fouled.

1. Place the transmission in neutral and lock the parking brake.
2. Turn the fuel tank valve on, sit on the vehicle, and turn the engine stop switch to *RUN*.
3. Disengage the clutch and press the start button to start the engine.

NOTE: If the engine has cooled to a point where it does not readily start, intermittent use of the choke button (pulled half way out) may be necessary.

NOTE: If you believe the engine is over-choke when warm, push the choke lever completely in and depress the throttle lever fully while cranking to aid in starting. Release the throttle lever *immediately* after the engine starts.

4. If the engine does not start, review the engine troubleshooting information beginning on page 167. If all conditions are favorable and the engine still does not start, see your Polaris dealer for service.

Driving Safely

Driving Procedures

1. Sit upright with both feet on the footpegs and both hands on the handlebars.
2. Start the engine and allow it to warm up, then shift the transmission into gear. See page 67.
3. Check your surroundings and determine your path of travel.
4. Release the parking brake.
5. Slowly depress the throttle with your right thumb while slowly releasing the clutch lever to begin driving.
6. Drive slowly. Practice maneuvering and using the throttle, clutch and brakes on level surfaces.

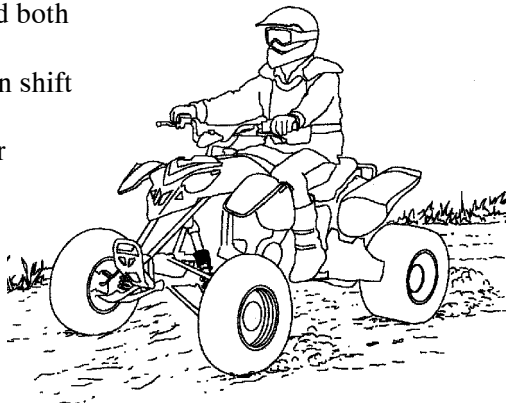

OPERATION

Driving Safely

Making Turns

Your ATV is equipped with a solid rear axle, which drives both rear wheels equally at all times. The wheel on the outside of the turn travels a greater distance than the inside wheel when turning, and the inside tire slips traction slightly. To turn, steer in the direction of the turn, leaning your upper body to the inside of the turn while supporting your weight on the outer footpeg. This technique alters the balance of traction between the rear wheels, allowing the turn to be made smoothly.

NOTE: Practice making turns at slow speeds before attempting to turn at faster speeds.

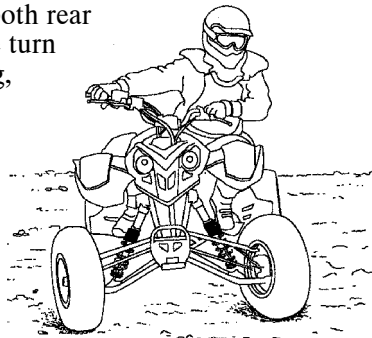

WARNING

Turning at sharp angles or at excessive speeds can result in vehicle overturn and lead to serious injury or death. Avoid turning at sharp angles. Never turn at high speeds.

Driving Safely

Driving on Slippery Surfaces

Whenever riding on slippery surfaces such as wet trails or loose gravel, or during freezing weather, follow these precautions:

1. Slow down when entering slippery areas.
2. Maintain a high level of alertness, reading the trail and avoiding quick, sharp turns, which can cause skids.
3. Correct a skid by turning the handlebars in the direction of the skid and shifting your body weight forward.

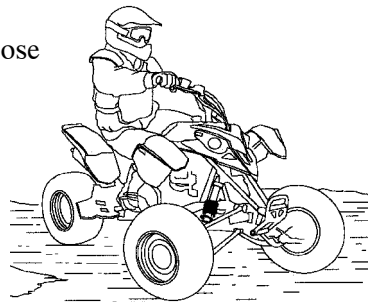

WARNING

Failure to exercise care when operating on slippery surfaces can result in loss of tire traction and cause loss of control, accident, and serious injury or death.

Never apply the brakes during a skid. Do not operate on excessively slippery surfaces. Always reduce speed and use additional caution, especially when downshifting.

OPERATION

Driving Safely

Driving Uphill

Whenever traveling uphill, follow these precautions:

1. Always travel straight uphill.
2. Avoid steep hills (25° maximum).
3. Keep both feet on the footpegs and transfer your weight forward.
4. Proceed at a steady rate of speed and throttle opening.
5. Be alert and prepared to take emergency action. This may include quick dismounting of the vehicle.

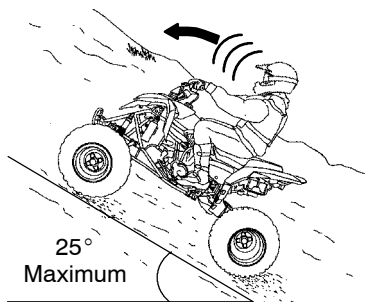

WARNING

Braking and handling are greatly affected when operating in hilly terrain. Improper procedure could cause loss of control or overturn and result in serious injury or death. Use extreme caution when operating on hills, and follow all procedures outlined in the owner's manual.

Driving Safely

Driving Across Hills

WARNING

Improperly crossing hills or turning on hills can result in loss of control or vehicle overturn, resulting in severe injury or death. Avoid crossing the side of a hill when possible. Follow proper procedures as outlined in the owner's manual.

If you enter into a situation where sidehilling is unavoidable:

1. Slow down.
2. Lean into the hill, transferring your upper body weight toward the hill while keeping your feet on the footpegs.
3. Steer slightly into the hill to maintain vehicle direction.

NOTE: If the vehicle begins to tip, quickly turn the front wheels downhill, if possible, or dismount on the uphill side *immediately!*

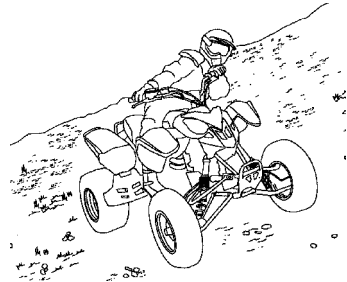

OPERATION

Driving Safely

Turning Around on a Hill

WARNING

Improper hill climbing procedures could cause loss of control or overturn and result in serious injury or death. Avoid climbing steep hills (25° maximum). Use extreme caution when operating on hills, and follow proper operating procedures outlined in the owner's manual.

If the vehicle stalls while climbing a hill, never back it down the hill! One maneuver that can be used when it's necessary to turn around while climbing a hill is the K-turn:

1. Keep your body weight uphill.
2. Pull in the clutch lever and apply the front and rear brakes.
3. When completely stopped, shut off the engine. Leaving the transmission in gear, release the clutch lever and lock the park brake.
4. Dismount on the uphill side of the vehicle, or on the left side if the vehicle is pointing straight uphill.

Driving Safely

Turning Around on a Hill

5. Staying uphill of the ATV, turn the handlebars full left. Reach across the handlebar and apply the front brakes to unlock the park brake.
6. With the front brakes applied, pull in the clutch lever. Use the brakes to slowly allow the vehicle to roll around to your right until it's pointing across the hill or slightly downward.
7. With the front brakes still applied, release the clutch lever and lock the park brake. Remount from the uphill side, keeping body weight uphill.
8. Pull in the clutch lever, shift into neutral and restart the engine.
9. Release the park brake and slowly release the clutch lever, allowing the ATV to proceed *slowly*. Stay in first gear, using the brakes for additional speed control if necessary, until more level ground is reached. Do not apply the brakes abruptly when driving downhill.

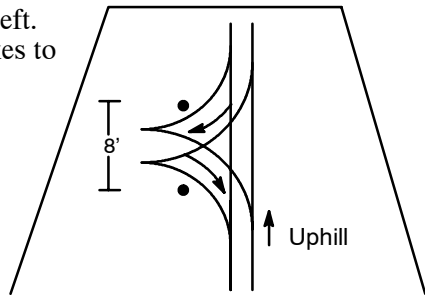

OPERATION

Driving Safely

Driving Downhill

Whenever descending a hill, follow these precautions:

1. Proceed directly downhill.
2. Transfer your weight to the rear of the vehicle.
3. Slow down.
4. Shift to the lowest gear possible while maintaining a safe speed.
5. Apply the foot brake *slightly* to aid in slowing.

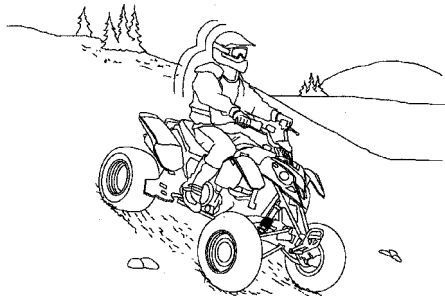

WARNING

Excessive speed can cause loss of control and lead to serious injury or death. Always operate slowly when traveling downhill.

Driving Safely

Parking on an Incline

Avoid parking on an incline if possible. If it's unavoidable, follow these precautions:

1. Turn the engine off.
2. Place the transmission in first gear.
3. Lock the parking brake.
4. Always block the rear wheels on the downhill side. See illustration.
5. Shut off the fuel supply.

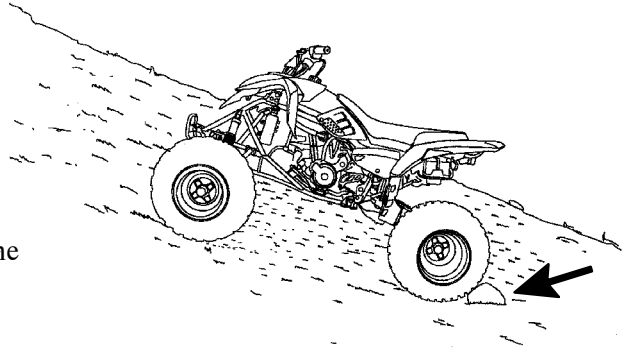

OPERATION

Driving Safely

Driving Through Water

Your ATV can operate through water with a maximum recommended depth equal to the level of the footpegs (1). Follow these procedures when operating through water:

1. Determine water depths and current before crossing.
2. Choose a crossing where both banks have gradual inclines.
3. Proceed slowly, avoiding rocks and obstacles if possible.
4. After crossing, dry the brakes by applying light pressure to the lever until braking action is normal.

After running the vehicle in water, it's *critical* to have it serviced as outlined in the maintenance chart. See page 91. The engine oil and all grease fittings need special attention.

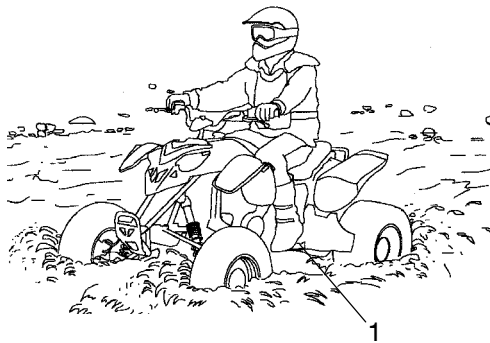

Driving Safely

Driving Through Water

CAUTION

Major engine damage can result if the vehicle is not thoroughly inspected after operation in water. Perform the services outlined in the maintenance chart.

If your vehicle becomes immersed or is operated in water that exceeds the footpeg level, take it to your dealer for service before starting the engine.

NOTE: Avoid operating the vehicle through deep or fast-flowing water. If you cannot avoid water that exceeds the recommended maximum depth, go slowly, balance your weight carefully, avoid sudden movements, and maintain a slow and steady forward motion. Do not make sudden turns or stops, and do not make sudden throttle changes.

If your vehicle becomes immersed, and it's impossible to take it to a dealer before starting it, follow the steps described on page 132. Have the vehicle serviced by your dealer at the first opportunity.

OPERATION

Driving Safely

Driving Over Obstacles

Be alert!

Look ahead and learn to read the terrain you're traveling on. Be constantly alert for hazards such as logs, rocks and low hanging branches.

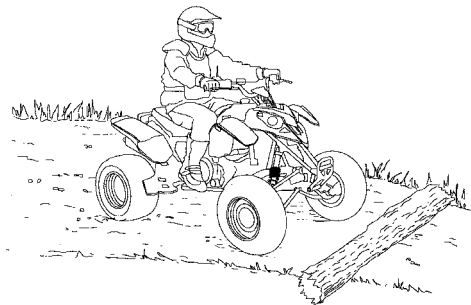

⚠️ WARNING

Severe injury or death can result if your vehicle comes in contact with a hidden obstacle. Not all obstacles are immediately visible. Travel with caution in unfamiliar terrain.

EMISSION CONTROL SYSTEMS

Noise Emission Control System

Do not modify the engine, intake or exhaust components, as doing so may affect compliance with state and local noise level requirements.

Spark Arrestor

Your Polaris vehicle has a spark arrestor that was tested and approved in accordance with the USDA Forest Service Standard 5100-1C. Federal law requires that this spark arrestor be installed and functional when the vehicle is operated on public lands.

Crankcase Emission Control System

This engine is equipped with a closed crankcase system. Blow-by gases are forced back to the combustion chamber by the intake system. The system does not allow the blow-by gases to enter the atmosphere.

EMISSION CONTROL SYSTEMS

Exhaust Emission Control System

The emissions from the exhaust of this vehicle are controlled by engine design, including factory-set carburetion and ignition. The engine and related components must be maintained at Polaris specifications to achieve optimal performance.

Adjustment to engine idle is the only adjustment Polaris recommends that the operator perform. Any other adjustments should be performed by an authorized Polaris dealer.

The emissions label (1) is located on the recoil cover.

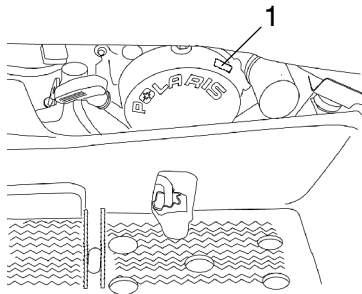

MAINTENANCE AND LUBRICATION

Periodic Maintenance Schedule

Careful periodic maintenance will help keep your vehicle in the safest, most reliable condition. Inspection, adjustment and lubrication of important components are explained in the following pages. And to help you perform routine maintenance, a tool kit is provided in the storage compartment under the seat. Items included in the kit are:

- Spark plug socket and handle
- Open end wrench, 1/2 in. and 10 mm
- Torx® T25 screwdriver
- L-wrench, T-27
- Tire pressure gauge

Maintenance intervals are based upon average riding conditions and an average vehicle speed of approximately 10 miles per hour. Vehicles subjected to severe use, such as operation in wet or dusty areas, should be inspected and serviced more frequently.

Inspect, clean, lubricate, adjust and replace parts as necessary. When inspection reveals the need for replacement parts, use genuine Polaris parts available from your Polaris dealer.

NOTE: Service and adjustments are critical. If you're not familiar with safe service and adjustment procedures, have a qualified dealer perform these operations.

MAINTENANCE AND LUBRICATION

Periodic Maintenance Schedule

Hours of operation are based on a 10 mph average. For example, if a service is due at 20 hours, the equivalent odometer reading would be 200 miles. Perform all services at whichever reading is reached first: hours of operation, miles logged, or time elapsed. Perform all services more frequently under severe use.

WARNING

Improperly performing the procedures marked with a ■ could result in component failure and lead to serious injury or death. Have an authorized Polaris dealer perform these services.

Maintenance Chart Key

- ▶ Perform these operations more often under severe use, such as in dirty or wet conditions, to purge water or dirt contamination from grease fittings and other critical components.
- ★ Emission Control System Service (California - 4-Cycle)
- Dealer service item.
- Use Polaris Premium All Season Grease or grease conforming to NLGI No. 2, such as Conoco Superlube M or Mobilegrease Special

MAINTENANCE AND LUBRICATION

Periodic Maintenance Schedule

	Item	Hours/Miles	Frequency	Remarks
	Brake systems/fluid	Pre-Ride	Pre-Ride	Inspect; maintain fluid level between fill lines (see page 60); change every 200 mi. or 24 months
	Tires	Pre-Ride	Pre-Ride	Inspect
	Wheels/lug nuts	Pre-Ride	Pre-Ride	Inspect; tighten
	Frame fasteners	Pre-Ride	Pre-Ride	Inspect; tighten
▶ ★	Air filter and Pre-cleaner	Pre-Ride	Pre-Ride	Inspect; clean
	Coolant	Pre-Ride	Pre-Ride	Inspect level; add as needed
	Fuel	Pre-Ride	Pre-Ride	Fill to proper levels
▶	Engine/transmission oil	Pre-Ride	Pre-Ride	Fill to proper level with Polaris PS-4 oil
	Throttle	Pre-Ride	Pre-Ride	Check operation
▶	Clutch	Pre-Ride	Pre-Ride	Check operation and adjustment
	Lights	Pre-Ride	Pre-Ride	Check operation
	Engine stop switch	Pre-Ride	Pre-Ride	Check operation

MAINTENANCE AND LUBRICATION

Periodic Maintenance Schedule

WARNING

Improperly performing the procedures marked with a ■ could result in component failure and lead to serious injury or death. Have a Polaris dealer perform these services.

	Item	Hours/Miles	Frequency	Remarks
▶	Steering	Pre-Ride	Pre-Ride	Check for free operation and loose components
▶	Air box sediment tubes	Pre-Ride	Pre-Ride	Drain deposits when visible
	Headlamp	Pre-Ride	Pre-Ride	Check daily; apply Polaris dielectric grease to connector when replaced
	Tail lamp/brake lamp	Pre-Ride	Pre-Ride	Check daily; apply Polaris dielectric grease to socket when replaced
■	A-arm ball joint	Pre-Ride	Pre-Ride	Check freeplay daily; have dealer replace if wheel moves excessively

MAINTENANCE AND LUBRICATION

Periodic Maintenance Schedule

	Item	Hours/Miles	Frequency	Remarks
▶ ★	Air filter, main element	Weekly	Weekly	Inspect; replace as needed
▶	Oil Change	10 hrs.	6 months	Perform break-in service at one hour; change oil more often in very cold or hot weather or under severe use
▶ ★	Oil Filter	10 hrs.	6 months	Replace with oil change; perform break-in oil/filter change at one hour
■	Brake pad wear	10 hrs.	Monthly	Inspect periodically
	Battery	20 hrs.	Monthly	Check terminals; clean
▶ ★	Engine breather filter	20 hrs.	Monthly	Inspect; clean as needed
▶ ●	General lubrication	50 hrs.	3 months	Lubricate all fittings, pivots, cables









- ▶ More often under severe use, such as dirty or wet conditions
- ★ Emission Control System Service (California)
- Dealer service item
- Polaris Premium All Season Grease

MAINTENANCE AND LUBRICATION

Periodic Maintenance Schedule

WARNING

Improperly performing the procedures marked with a ■ could result in component failure and lead to serious injury or death. Have a Polaris dealer perform these services.

	Item	Hours/Miles	Frequency	Remarks
 	A-Arm (A)	50 hrs.	3 months	Inspect; tighten fasteners; grease (also after washing ATV or driving in water)
 	Rear axle/ Rear eccentric (B)	25 hrs.	3 months	Inspect; grease (also after washing ATV or driving in water)
 	Swing arm pivot	25 hrs.	3 months	Disassemble components, clean and grease
 	Upper steering post (C)	50 hrs.	6 months	Inspect; tighten fasteners; grease after washing ATV or driving in water

 More often under severe use, such as dirty or wet conditions

 Emission Control System Service (California)

 Dealer service item

 Polaris Premium All Season Grease

MAINTENANCE AND LUBRICATION

Periodic Maintenance Schedule

Lubrication Points

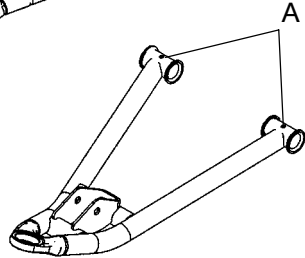
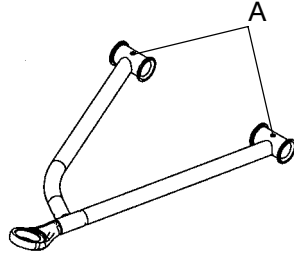
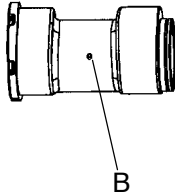
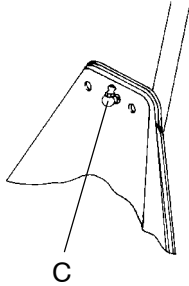

MAINTENANCE AND LUBRICATION

Periodic Maintenance Schedule

WARNING

Improperly performing the procedures marked with a ■ could result in component failure and lead to serious injury or death. Have a Polaris dealer perform these services.

	Item	Hours/Miles	Frequency	Remarks
	Carburetor float bowl	50 hrs.	6 months	Drain bowl periodically and prior to storage
■	Throttle Cable/ETC Switch	50 hrs.	6 months	Inspect; adjust; replace if necessary
★	Choke (enricher) cable	50 hrs.	6 months	Inspect; adjust; lubricate; replace if necessary
▶	Drive chain(s)	50 hrs.	6 months	Inspect daily; adjust and lubricate if needed
★ ▶	Engine breather hose and filter (in airbox)	50 hrs.	6 months	Inspect

MAINTENANCE AND LUBRICATION

Periodic Maintenance Schedule

	Item	Hours/Miles	Frequency	Remarks
	Coolant strength	50 hrs.	6 months	Inspect strength seasonally; pressure test system annually
	Coolant system pressure test	100 hrs.	Annually	Pressure test system annually
★	Spark plug	100 hrs.	Annually	Inspect; replace as needed
■ ★	Ignition Timing	NA	Annually	Inspect; adjust as needed
■ ★	Fuel system	100 hrs.	Annually	Check for leaks at tank cap, lines, fuel valve, pump and carburetor; replace lines every two years

- ▶ More often under severe use, such as dirty or wet conditions
- ★ Emission Control System Service (California)
- Dealer service item
- Polaris Premium All Season Grease

MAINTENANCE AND LUBRICATION

Periodic Maintenance Schedule

	Item	Hours/Miles	Frequency	Remarks
	Radiator	100 hrs.	Annually	Inspect; clean external surface; change coolant every 2 years
▶	Cooling system hoses	100 hrs.	Annually	Inspect
	Engine mounts	100 hrs.	Annually	Inspect
■	Brake fluid	200 hrs.	24 months	Change every two years
	Spark arrestor	300 hrs.	36 months	Clean out
■	Front wheel bearings	300 hrs.	36 months	Inspect; replace as needed
★	Idle speed		As required	Adjust
■	Toe adjustment		As required	Periodic inspection; adjust when parts are replaced
	Headlight aim		As required	Adjust as needed

▶ More often under severe use, such as dirty or wet conditions

★ Emission Control System Service (California)

■ Dealer service item

● Polaris Premium All Season Grease

NOTES

MAINTENANCE AND LUBRICATION

Periodic Maintenance Record

Use the following chart to record periodic maintenance.

Maintenance Interval Performed	Servicing Date	Servicing Dealer or Person	Remarks
10 hrs.			
20 hrs.			
50 hrs.			
100 hrs.			

MAINTENANCE AND LUBRICATION

Periodic Maintenance Record

Maintenance Interval Performed	Servicing Date	Servicing Dealer or Person	Remarks

MAINTENANCE AND LUBRICATION

Lubrication Recommendations

Performance Synthetic 4-Stroke (PS-4) Oil

Polaris highly recommends the use of Polaris PS-4 or a similar oil designed for use in 4-stroke manual clutch ATV and motorcycle applications. PS-4 has been specifically formulated for use in high performance engines. PS-4 is a fully synthetic, high performance, multi-viscosity oil designed to provide the ultimate in lubrication performance and protection and prolonged clutch life. **NOTE:** See page 175 for the part numbers of Polaris products.

PS-4 oil possesses unsurpassed film strength over the widest possible temperature range. It resists viscosity and frictional breakdown in ambient temperatures from -40° F. to $+120^{\circ}$ F. (-40° to $+49^{\circ}$ C.). Its exceptional frictional properties result in more efficient operation, more power output and lower fuel consumption.

CAUTION

Mixing brands or using a non-recommended oil may cause serious engine damage. Polaris recommends the use of Polaris PS-4 oil. Never mix oil brands.

MAINTENANCE AND LUBRICATION

Engine Oil Level

Check the oil level before each use of the vehicle.
The dipstick (1) is located on the left side of the ATV.

1. Position the ATV on a level surface.
2. Start the engine and let it idle for one minute.
3. Stop the engine and remove the dipstick. Wipe it dry with a clean cloth.
4. Reinstall the dipstick completely. **NOTE:** The dipstick must be screwed completely in to keep the angle and depth of the stick consistent.
5. Remove the dipstick and check the oil level. Maintain the oil level in the safe range (2), between the full and add marks. Do not overfill.
6. Reinstall the dipstick.

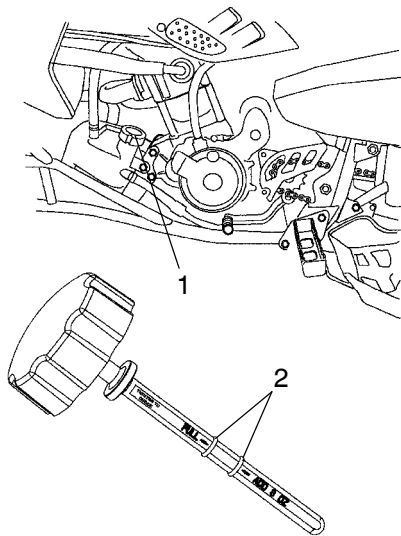

MAINTENANCE AND LUBRICATION

Engine Oil Level

If the ATV is used year-round, check the oil level frequently. A rising oil level could indicate the accumulation of contaminants such as water or excess fuel in the bottom of the oil tank. Water in the bottom of the tank can lead to engine damage and must be drained. Water accumulation increases as outside temperature decreases.

MAINTENANCE AND LUBRICATION

Oil and Filter Change

CAUTION

If the ATV is left without oil in the system for extended periods, the oil pump may lose its prime, which could result in engine damage. Do not allow the vehicle to be without oil and filter overnight. Always replace the oil and filter within a few hours of draining the oil.

The suggested break-in oil change should be performed after one hour of operation, or after the first tank of fuel, whichever comes first. Perform the next oil and filter changes every 10 hours or every six months, whichever comes first.

Severe use operation requires more frequent service. Severe use includes continuous duty in dusty or wet conditions and operating in very cold or very hot weather. Severe use cold weather riding is all riding below 10° F. (-12° C.), and riding between 10° F. and 40° F. (-12° and 4° C.) when most trips are slow speed and less than 5 miles.

MAINTENANCE AND LUBRICATION

Oil and Filter Change

1. Place the vehicle on a level surface.
2. Clean the area around the oil tank (1) and crankcase (2) drain plugs with clean shop towels.
3. Run the engine for two to three minutes until warm, then stop the engine.
4. Place a drain pan beneath the oil tank and remove the drain plug.

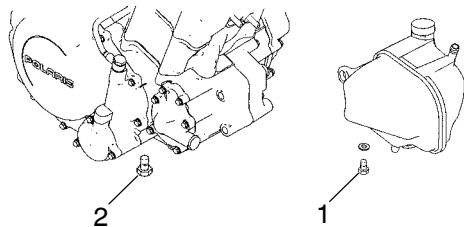

CAUTION

Hot oil can cause serious burns to skin. Do not allow hot oil to contact skin.

5. Allow the oil to drain completely.
6. Replace the sealing washer and reinstall the plug. Torque to 14 ft. lbs. (19 Nm).
NOTE: The sealing surfaces on drain plugs, oil tank and crankcase should be clean and free of burrs, nicks or scratches.

MAINTENANCE AND LUBRICATION

Oil and Filter Change

7. Place a drain pan beneath the crankcase and remove the drain plug.
8. Allow the oil to drain completely.
9. Replace the sealing washer and reinstall the plug. Torque to 14 ft. lbs. (19 Nm).
10. Place shop towels beneath the oil filter.
11. Remove the three cover bolts and remove the cover.
12. Pull out the oil filter. **NOTE:** A spring located behind the filter may pop out as the filter is removed. The spring must be reinstalled with the new filter.
13. Using a clean dry cloth, clean the filter sealing surfaces.

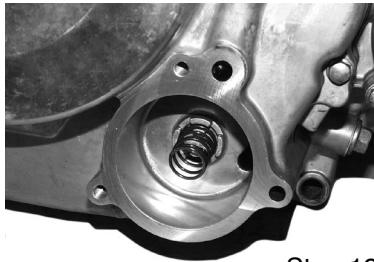

Step 12

MAINTENANCE AND LUBRICATION

Oil and Filter Change

14. Replace the o-ring in the cover.
15. Lubricate the gasket on the new filter with a film of fresh engine oil.
16. Reinstall the spring and install the new filter with the open end facing outward.
17. Install the cover and torque the bolts to 72-78 in. lbs. (8-9 Nm). **NOTE:** The long bolt must be placed in the forward hole.



Step 14



Step 16

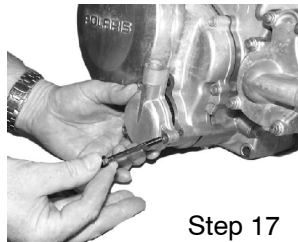

Step 17

MAINTENANCE AND LUBRICATION

Oil and Filter Change

18. Remove the dipstick and fill the oil tank with 2 quarts (1.9 l) of recommended oil.
19. Place the transmission in neutral and set the parking brake.
20. Start the engine and let it idle for one to two minutes. Stop the engine and inspect for leaks.
21. Re-check the oil level on the dipstick and add oil as necessary to bring the level to the upper mark on the dipstick.
22. Dispose of the used filter, oil and shop towels properly.

MAINTENANCE AND LUBRICATION

Air Filter Systems

1. Unlatch and remove the seat.
2. Loosen the intake duct clamp (1) on the carburetor.
3. Pull the duct (2) off the carburetor.
4. Release the eight airbox cover clips (3) and remove the cover (4).
5. Remove the air filter (5). Inspect and replace if necessary.
6. Remove the pre-filter (6) and breather filter (7). Wash both in soapy water, then rinse, let dry and reinstall.

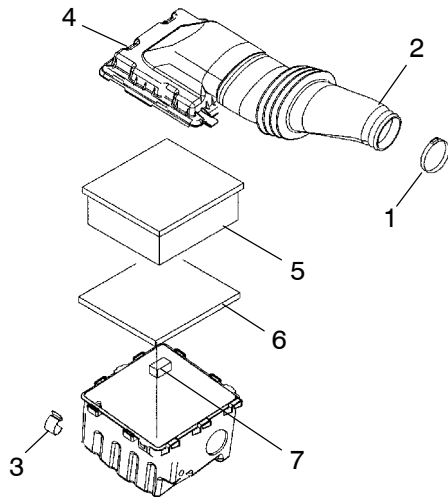

MAINTENANCE AND LUBRICATION

Air Filter Systems

7. Reinstall the air filter.
8. Reinstall the airbox cover and secure the clips.
9. Reinstall the intake duct to the carburetor and secure the clamp.
10. Check the hoses for cracks, deterioration, abrasion, or leaks. Replace as needed.

CAUTION

Operation of your vehicle without a breather filter can cause engine damage. Always reinstall the breather filter after removing for service.

MAINTENANCE AND LUBRICATION

Engine Cooling System

The engine coolant level is controlled or maintained by the recovery system. The recovery system components are the recovery bottle, radiator filler neck, radiator pressure cap and connecting hose.

To ensure that the coolant maintains its ability to protect the engine, we recommend that you completely drain the cooling system every two years and add a fresh mixture of antifreeze and water.

Polaris recommends the use of Polaris Premium 60/40 anti-freeze/coolant or a 50/50 mixture of high quality aluminum compatible anti-freeze/coolant and distilled water. See page 175 for the part numbers of Polaris products.

NOTE: Polaris Premium 60/40 is already premixed and ready to use. Do not dilute with water.

NOTE: Always follow the manufacturer's mixing recommendations for the freeze protection required in your area.

MAINTENANCE AND LUBRICATION

Engine Cooling System

Coolant Level

The recovery bottle (1) is located on the left side of the machine under the front fender. The fluid level must be maintained between the minimum and maximum marks on the bottle (when the fluid is cool).

As coolant operating temperature increases, the expanding (heated) excess coolant is forced out of the radiator, past the pressure cap, and into the recovery bottle. As engine coolant temperature decreases, the contracting (cooled) coolant is drawn back up from the tank, past the pressure cap, and into the radiator.

NOTE: Some coolant level drop on new machines is normal, as the system is purging itself of trapped air. Observe coolant levels and maintain as recommended by adding coolant to the recovery bottle.

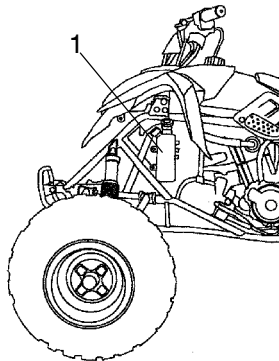

MAINTENANCE AND LUBRICATION

Engine Cooling System

WARNING

Escaping steam can cause severe burns. Never remove the pressure cap while the engine is warm or hot. Always allow the engine to cool before removing the cap.

Radiator Coolant Level

NOTE: This procedure is required only if the cooling system has been drained for maintenance and/or repair. However, if the recovery bottle has run dry, inspect the level in the radiator and add coolant if necessary.

1. Remove the pressure cap.
2. Using a funnel, slowly add coolant as necessary through the radiator filler neck.
3. Replace the pressure cap.

NOTE: Use of a non-standard pressure cap will not allow the recovery system to function properly. Contact your dealer for the correct replacement part.

MAINTENANCE AND LUBRICATION

Lights

When servicing a halogen lamp, don't touch the lamp with bare fingers. Oil from your skin leaves a residue, causing a hot spot that will shorten the life of the lamp.

WARNING

Poor lighting while driving can result in severe injury or death. Headlight and taillight lenses become dirty during normal operation. Wash the headlights frequently to maintain lighting quality.

Hot components can cause serious burns to skin. Do not service the headlamps until they've cooled sufficiently.

MAINTENANCE AND LUBRICATION

Lights

Headlight Lamp Replacement

1. Remove the wire harness connector from the back of the headlight.
2. On the left headlamp, grasp the bulb housing and turn it *counterclockwise* (1) to remove the bulb. On the right headlamp, turn the bulb housing *clockwise* (2) to remove the bulb.
3. Apply dielectric grease to the light bulb socket before installing the new bulb. Install the replacement bulb into headlight housing and rotate clockwise firmly. **NOTE:** The bulb must be positioned so the harness installs into the lamp at outer side.
4. Reinstall the connector to the back of the headlight.

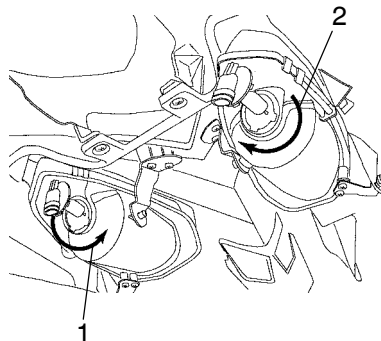

MAINTENANCE AND LUBRICATION

Lights

Headlight Assembly Replacement

1. Remove the wire harness connector from the headlights.
2. Remove the front cab (see page 124). Position the cab upside down on a soft protective surface to prevent scratching.
3. Remove the small adjuster bracket (1) and install it on the new lamp.
4. Remove the large pivot bracket (2) and remove the headlamp.

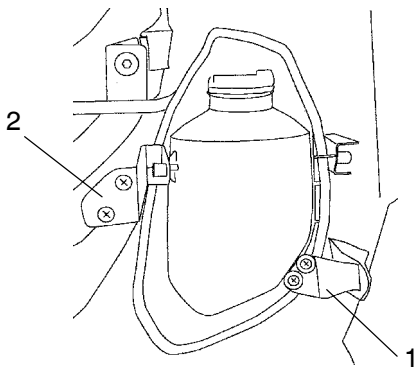

MAINTENANCE AND LUBRICATION

Lights

Headlight Assembly Replacement

5. Install the new headlamp by inserting the outboard pivot pin in the hole of the mounting tab on the cab.
6. Install the adjuster bracket onto the inboard pivot pin of the headlamp.
7. Adjust for approximately 1/16" clearance between the bracket and the edge of the headlight. Tighten the mounting screws. **IMPORTANT:** Be sure the bracket is 90 degrees to the pivot pin so the lamp can move freely.
8. Install the adjusting screw, leaving it loose so the headlight can be adjusted.
9. Reinstall the front cab and connect the wire harness to the headlamp.
10. Adjust the lamps as needed, then tighten the adjuster screw. See page 122.

MAINTENANCE AND LUBRICATION

Lights

Taillight/Brakelight Lamp Replacement

If the taillight/brakelight does not work the lamp may need to be replaced.

1. Remove the taillight lens cover mounting screws (1). Remove the lens cover (2) and gasket and set aside for reassembly.
2. Remove the lamp (3) and replace it with a new lamp.
3. Test the taillight/brakelight to see that it's working.
4. Reinstall the gasket and lens cover.

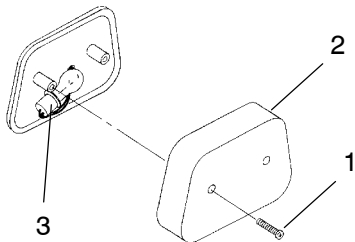

MAINTENANCE AND LUBRICATION

Lights

Headlight Adjustment

1. Position the ATV on a level surface with the headlight approximately 25 ft. (7.6 m) from a flat wall.
2. Measure the distance from the floor to the center of the headlight and make a mark on the wall at the same height.
3. Start the engine and turn the headlight switch to high beam.
4. Observe the headlight aim on the wall. The most intense part of the headlight beam should be aimed 2" (5.1 cm) below the mark placed on the wall. **NOTE:** Include rider weight on the seat when measuring.
5. Loosen the pivot screw (1) and adjust the beam to the desired position.
6. Tighten the screw and torque to 27 in. lbs. (3 Nm).

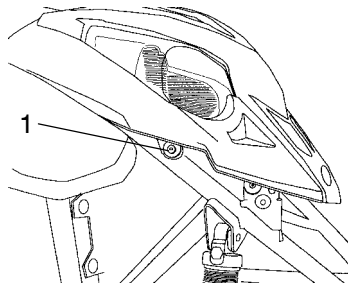

MAINTENANCE AND LUBRICATION

Side Panel Removal

1. Unlatch and remove the seat.
2. Remove the four screws (1) securing the side panel.
3. Remove the side panel.

Rear Cab Removal

1. Unlatch and remove the seat.
2. Remove the four bolts (2) on the rear fenders of the cab and the two bolts (3), washers and grommets (4) on the top of the cab.
3. Remove the two screws (5) from the rear cab supports.
4. Remove the cab.

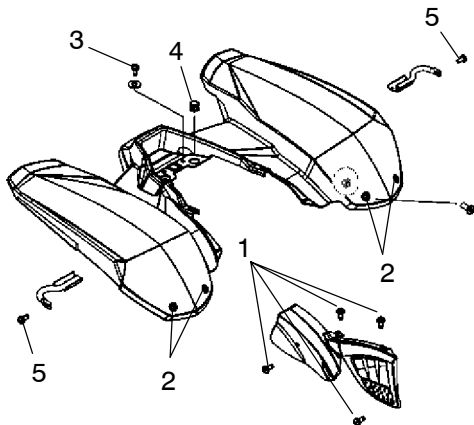

MAINTENANCE AND LUBRICATION

Front Cab Removal

1. Remove the screws and washers (1) from the front left-hand and right-hand cab mounts.
2. Remove the wire harness connector from the headlights.
3. Loosen the screw (2) located inside the cab under the front cover.
4. Gently pull the cab forward to remove the cab and disengage it from the stand-offs on the fuel tank.
5. Reverse all steps to reinstall the front cab.

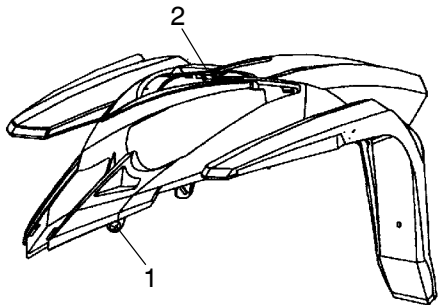

MAINTENANCE AND LUBRICATION

Spark Plugs

- Use NGK DCPR8E spark plugs.
- Proper electrode gap is .035" (.90 mm).
- Spark plug torque is 14 ft. lbs. (19 Nm).

CAUTION

Using non-recommended spark plugs may result in serious engine damage and may void your emission-related warranty. Always use Polaris-recommended spark plugs.

Spark plug condition is indicative of engine operation. The spark plug firing end condition should be read after the engine has been warmed up and the vehicle has been driven at higher speeds. Immediately check the spark plug for correct color.

WARNING

A hot exhaust system and engine can cause serious burns. Wear protective gloves when removing a spark plug for inspection. Allow components to cool before continuing.

MAINTENANCE AND LUBRICATION

Spark Plugs

1. Normal

The normal insulator tip is gray, tan or light brown. There will be few combustion deposits. The electrodes are not burned or eroded. This indicates the proper type and heat range for the engine and the service.

NOTE: The tip should not be white. A white insulator tip indicates overheating, caused by use of an improper spark plug or incorrect carburetion adjustments.

2. Wet Fouled

The wet fouled insulator tip is black. A damp oil film covers the firing end. There may be a carbon layer over the entire nose. Generally, the electrodes are not worn. General causes of fouling are excessive oil, use of non-recommended oil, improper use of the choke, or incorrect carburetion adjustments.

MAINTENANCE AND LUBRICATION

Spark Plugs

Spark Plug Removal and Replacement

1. Remove the side panels and front cab (see pages 123-124).
2. Turn the fuel valve to OFF.

WARNING

A hot ember on the ATV could cause fuel to ignite. Allow all components to cool sufficiently before accessing the spark plug. Always exercise extreme caution when handling fuel systems and gasoline. Always heed the fuel warnings on page 69.

MAINTENANCE AND LUBRICATION

Spark Plugs

Spark Plug Removal and Replacement

3. Move the fuel valve hose clamp (1) forward and gently remove the hose from the fuel valve fitting on the gas tank.
4. Remove the vent hose (2) from the instrument panel, taking note of the hose routing for reinstallation.
5. Remove the tank mounting bolt (3) at the rear of the gas tank.
6. Move the tank rearward and upward over the engine. Slowly remove the tank and be careful not to catch any hoses, wires or other components. Place the tank on a stable surface or work bench. Be sure to protect the valve from contamination or damage.

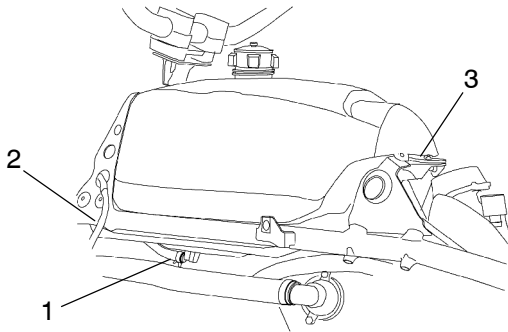

MAINTENANCE AND LUBRICATION

Spark Plugs

Spark Plug Removal and Replacement

7. Using the forked end of the spark plug wrench handle, remove the spark plug boot.
IMPORTANT: Do not pull on the wire to remove the boot. Doing so may cause a wire disconnection inside the boot.
8. Using the spark plug wrench and handle, rotate counterclockwise to remove the spark plug.
9. Reverse all steps to install the spark plug and reassemble the body. Torque the spark plug to 14 ft. lbs. (19 Nm). Be sure to reroute the vent hose (1) through the instrument panel. Torque the tank mounting bolt to 9 ft. lbs. (12 Nm).

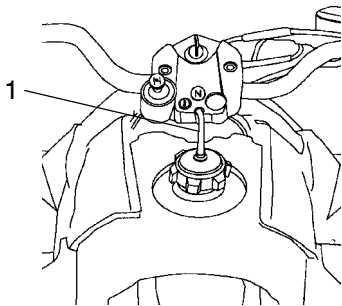

MAINTENANCE AND LUBRICATION

Spark Arrestor

WARNING

Failure to heed the following warnings while servicing the spark arrestor could result in serious injury or death.

Do not perform service on the spark arrestor while the system is hot. Exhaust system temperatures can reach 1000° F. Allow components to cool sufficiently before proceeding.

Remove any combustible materials from the area. Wear eye protection and leather work gloves. Do not stand behind or in front of the vehicle while purging. Never run the engine in an enclosed area. Exhaust contains poisonous carbon monoxide gas. Never go under the vehicle while it's inclined.

MAINTENANCE AND LUBRICATION

Spark Arrestor

Periodically clean the spark arrestor to remove accumulated carbon.

1. Remove the three screws (1) and remove the arrestor (2) from the end of the muffler.
2. Use a non-synthetic brush to clean the arrestor screen (3). A synthetic brush may melt if components are warm.
3. Inspect the screen for erosion and replace if necessary.
4. Remove and inspect the gasket. Replace if worn or damaged.
5. Reinstall the gasket and arrestor.
6. Torque screws to 50 in. lbs. (5.6 Nm). Do not over-tighten.

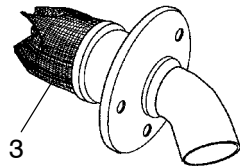
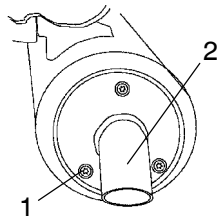

MAINTENANCE AND LUBRICATION

Vehicle Immersion

If your ATV has been submerged or overturned in water deeper than the footpeg level, it's critical to dry it promptly and properly before starting the engine.

CAUTION

Do not start the engine after an ATV has been in water that exceeds the recommended depth. Serious engine damage WILL occur. Tow or trailer the ATV to your dealer for service. In an emergency, perform the temporary drying out procedure outlined below, which will allow *short-term operation only*, to drive the ATV to a trailer or towing vehicle.

Do not perform the following procedures if you don't feel completely capable, or if you suspect that water has entered the fuel tank (likely if the water was deep or if the ATV overturned). Tow or trailer the ATV to your dealer for immediate service.

1. Turn the fuel valve off.
2. Drain water from the air box and change the air filter (if equipped). See page 112.
3. Drain the fuel/water from the carburetor for about 10 seconds.
4. Remove the spark plug. See page 127.

MAINTENANCE AND LUBRICATION

Vehicle Immersion

WARNING

Fluids will be ejected through the spark plug hole and may cause serious injury to face or other body parts. Stand clear of the spark plug while performing the following steps.

5. Intermittently and briefly touch the starter button in half-second intervals to **SLOWLY** rotate the engine three or four times. Water will eject from the spark plug hole.
6. Press and hold the starter button for 10 second intervals for about one minute or until water vapor is no longer ejecting from the spark plug hole.
7. Check the oil level on the dipstick. If the level is higher than the pre-ride inspection level, water has entered the oil tank. *Do not start the engine.* Tow the ATV and see your dealer. If the oil level is unchanged from the pre-ride inspection level, replace the spark plug, start the engine and move the ATV promptly to a trailer or towing vehicle.

CAUTION

If water isn't removed promptly from a submerged ATV, rust will form in precision components, gears, bearings, the cylinder and other areas and result in serious engine damage. Always see your dealer promptly after an ATV has been submerged.

MAINTENANCE AND LUBRICATION

Battery

The YUASA sealed battery is already filled with electrolyte and has been sealed and *fully charged* at the factory. *Never* pry the sealing strip off or add any other fluid to this battery.

Keep battery terminals and connections free of corrosion. If cleaning is necessary, remove the corrosion with a stiff wire brush. Wash with a solution of one tablespoon baking soda and one cup water. Rinse well with tap water and dry off with clean shop towels. Coat the terminals with dielectric grease or petroleum jelly.

WARNING

Improperly connecting or disconnecting battery cables can result in an explosion and cause serious injury or death. When removing a battery, always disconnect the negative (black) cable first. When reinstalling the battery, always connect the negative cable last.

Battery Removal

1. Remove the rear cab (see page 123) and disconnect the strap securing the battery in position.
2. Disconnect the black (negative) cable first, then disconnect the red (positive) cable.
3. Lift the battery out of the ATV.

MAINTENANCE AND LUBRICATION

Battery Installation

1. Set the battery in the battery holder.
2. Connect and tighten the red (positive) cable first, then connect and tighten the black (negative) cable.
3. Attach the hold-down strap and reinstall the rear cab.
4. Verify that cables are properly routed.

NOTE: When installing a new battery, make sure it's fully charged prior to its initial use. Using a new battery that has not been fully charged can damage the battery and result in a shorter life. It can also hinder vehicle performance.

Battery Storage

When the vehicle is placed in storage for three months or more, the battery should be removed and stored out of the sun in a cool, dry place. Test and recharge the battery monthly and before reusing.

MAINTENANCE AND LUBRICATION

Battery Charging (Sealed Battery)

The most important part of maintaining a sealed battery is keeping it fully charged.

The battery included with your ATV is sealed and the sealing strip cannot be removed. Use a voltmeter or multimeter to measure DC voltage. A fully charged battery will register 12.8 V or higher. If the voltage is less than 12.8 volts, recharge the battery.

NOTE: The Polaris Battery Tender™ battery charger can be left connected during the storage period and will automatically charge the battery if the voltage drops below a pre-determined point (see page 175).

When using an automatic charger such as the Polaris Battery Tender™, refer to the manufacturer's instructions for recharging. When using a constant current charger, use the guidelines on the following page for recharging.

WARNING

An overheated battery could explode, causing severe injury or death. Always watch charging times carefully. Stop charging if the battery becomes very warm to the touch. Allow it to cool before resuming charging.

MAINTENANCE AND LUBRICATION

Battery Charging (Sealed Battery)

NOTE: Always verify battery condition before and 1-2 hours after charging.

State of Charge	Voltage	Action	Charge Time* (Using constant current charger @ standard amps specified on top of battery)
100%	12.8-13.0 volts	None, check at 3 mos. from date of manufacture	None required
75%-100%	12.5-12.8 volts	May need slight charge, if no charge given, check in 3 months	3-6 hours
50%-75%	12.0-12.5 volts	Needs charge	5-11 hours
25%-50%	11.5-12.0 volts	Needs charge	At least 13 hours, verify state of charge
0%-25%	11.5 volts or less	Needs charge with desulfating charger	At least 20 hours

MAINTENANCE AND LUBRICATION

Tires

WARNING

Operating your ATV with worn tires, improperly inflated tires, non-standard tires or improperly installed tires will affect vehicle handling and could cause an accident resulting in serious injury or death.

Maintain proper tire pressure as described on the ATV decal and in the owner's manual.

Always use original equipment size and type when replacing tires.

Make sure the wheels are installed properly.

Always replace tires when the tread depth measures 1/8" (.3 cm) or less.

MAINTENANCE AND LUBRICATION

Tire Tread Depth

Always replace tires when tread depth is worn to 1/8" (.3 cm) or less. See illustration.

Wheel Removal

1. Stop the engine, place the transmission in gear and lock the parking brake.
2. Loosen the wheel nuts slightly.
3. Elevate the side of the vehicle by placing a suitable stand under the frame.
4. Remove the wheel nuts and remove the wheel.

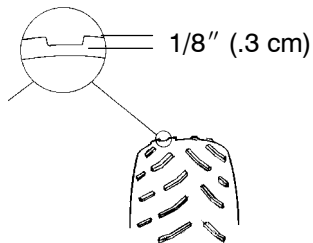

MAINTENANCE AND LUBRICATION

Wheel Installation

1. Place the transmission in gear and lock the parking brake.
2. Place the wheel on the wheel hub with the valve stem toward the outside and rotation arrows on the tire pointing toward forward rotation.
3. Install the wheel nuts and finger tighten.
4. Lower the vehicle to the ground.
5. Torque the wheel nuts according to the wheel nut torque specifications chart.

NOTE: Any nuts that have a cotter pin installed must be serviced by an authorized Polaris dealer.

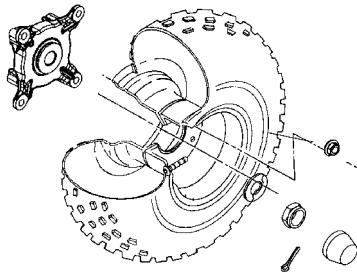

MAINTENANCE AND LUBRICATION

Wheel Nut Torque Specifications

Check the wheel nut torques occasionally and when they've been loosened for maintenance service.

Bolt Size	Specification
Front 3/8"	25 ft. lbs. (34 Nm)
Rear 3/8"	25 ft. lbs. (34 Nm)

ADJUSTMENTS

Brakes

Under normal operation, the diaphragm extends into the reservoir as fluid level drops. If the fluid level is low and the diaphragm is not extended, a leak is likely and the diaphragm should be replaced. Always fill the reservoir as needed whenever the cover is loosened or removed to ensure proper diaphragm operation. Do not overfill. See page 60.

The front brakes are hydraulic disc brakes. They're activated by squeezing the brake lever toward the handlebar. The rear brake is a hydraulic disc brake activated by the foot brake pedal. Both brakes are self-adjusting, but the following checks are recommended to keep the brake systems in good operating condition. Check more often if brakes are used heavily under normal operation.

WARNING

Overfilling the master cylinder will result in brake failure. Without room to expand, the excess fluid will cause the brakes to apply automatically, which could result in serious injury or death. Always maintain the fluid level between the MIN and MAX marks. See page 60.

ADJUSTMENTS

Brakes

1. Always maintain the brake fluid at an adequate level (see page 60).
2. Check the brake system for fluid leaks.
3. Check the brakes for excessive travel or spongy feel.
4. Check the friction pads for wear, damage and looseness.
5. Check the security and surface condition of the disc.
6. Inspect the rear brake disc spline and pad wear surface for excessive wear.

NOTE: Pads should be changed when worn to $3/64''$ (.1 cm), or about the thickness of a U.S. dime.

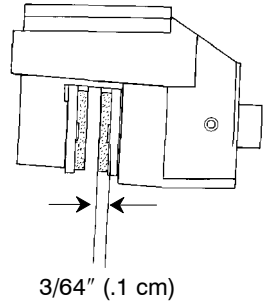

ADJUSTMENTS

WARNING

Severe injury or death can result from improper toe alignment and adjustment. Do not attempt to adjust tie rod alignment. All tie rod adjustments should be performed by an authorized Polaris dealer.

Toe Alignment

Use the following procedure to check the toe alignment of the vehicle. The Predator is designed for a neutral toe setting.

1. Set the handlebars in a straight-ahead position. Use tie straps to secure the handlebars so they can't move. **NOTE:** The steering arm can be used as an indicator of whether the handlebars are straight. The arm should always point straight back from the steering post.
2. Place stands (1) in front of the vehicle, perpendicular to the rear tires. See illustration.

ADJUSTMENTS

Toe Alignment

3. Tie an elastic string (2) around the stands, making sure the string just touches the side surface of the rear tires on each side of the vehicle and goes around the stands in front of the vehicle.
4. Measure the distance from the string to the rim at the front and rear of the front rim (3). The difference between these two measurements should be between 0" and 1/16" *toe out*.

NOTE: If you discover improper alignment, see your Polaris dealer for service.

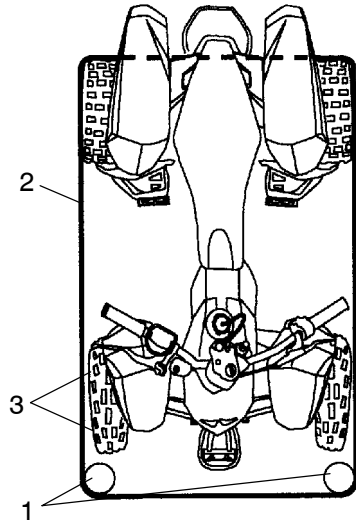

ADJUSTMENTS

Chain Tension

CAUTION

Never adjust or operate the vehicle with the rear drive chain too loose or too tight. Severe damage to the transmission and drive components can result. Chain tension must be inspected with the swing arm in the position shown in the illustration so that the axle, swing arm pivot and drive sprocket are aligned horizontally (B).

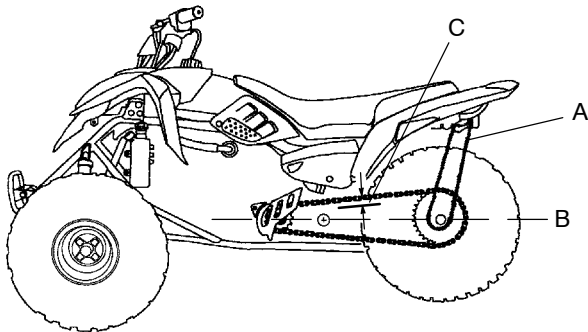

ADJUSTMENTS

Chain Tension

Check the amount of chain slack by moving the vehicle slightly forward to remove slack at the top side of the chain.

NOTE: The chain has a press-on master link. A chain tool must be used if it's necessary to remove the chain for service.

1. Collapse the suspension with an adjustable (buckle type) trailer tie down strap (A). Fasten the strap around the axle and rear bumper tube.
2. Tighten the strap until a straight line (B) can be drawn from the axle to the transmission output shaft, intersecting the swing arm pivot. This establishes the tightest chain position.
3. At this point (C) the chain should have 1/4" - 3/8" (.6 - .9 cm) deflection. Use the procedure on the following page if the chain needs adjustment.

ADJUSTMENTS

Chain Tension

1. Loosen the two eccentric locking bolts.
2. Insert a pin punch into the eccentric axle housing.
3. Roll the vehicle ahead or back to adjust chain slack to the proper dimension.
4. Tighten the eccentric locking bolts to 35 ft. lbs. (47.5 Nm).

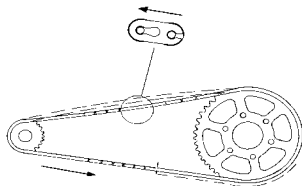
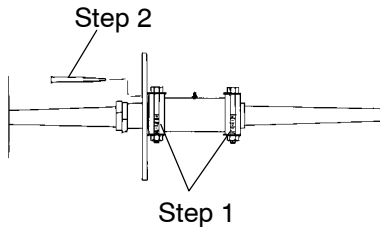

Proper Spicelink Clip Opening Position

ADJUSTMENTS

Steering Assembly

The steering assembly of the ATV should be checked periodically for loose nuts and bolts. If loose nuts and bolts are found, see your Polaris dealer for service before operating the vehicle.

Camber and Caster

The camber and caster are non-adjustable.

Suspension Settings

Setting	Compression Damping	Rebound Damping
Softest	Clicker Position 1	20 clicks from closed
Factory	Clicker Position 4	10 clicks from closed
Firmer	Clicker Position 8	Fully closed

ADJUSTMENTS

Front Suspension

The front suspension preload may be adjusted to suit different riding conditions and operator weight.

WARNING

Uneven adjustment may cause poor handling of the ATV, which could result in an accident and serious injury or death. Always adjust both the left and right spring preloads equally or have your Polaris dealer perform the adjustments.

ADJUSTMENTS

Front Suspension

Spring Preload

1. Raise and safely support the front of the ATV off the ground to allow the suspension to fully extend.
2. Turn the adjusting ring to the left (A) to increase preload. Turn the ring to the right (B) to decrease preload. **NOTE:** See Suspension Settings on page 149.

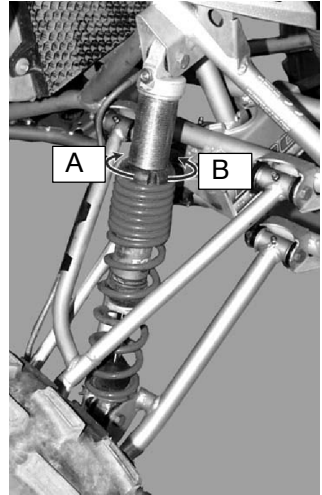

ADJUSTMENTS

Rear Suspension

The rear suspension spring preload, shock rebound damping and shock compression damping may be adjusted to suit different riding conditions and operator weight.

Spring Preload

1. Raise and safely support the rear of the ATV off the ground to allow the suspension to fully extend.
2. Loosen the jam nut (1) and back it away from the adjusting ring.
3. Turn the adjusting ring (2) to the left (A) to increase preload. Turn the ring to the right (B) to decrease preload. See Suspension Settings on page 149.
4. Tighten the jam nut firmly against the adjuster ring.

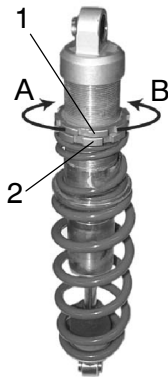

ADJUSTMENTS

Rear Suspension

Rebound Damping

1. Locate the rebound damping clicker drum between the lower spring seat and the lower shock mount.
2. Turn the clicker to the left (A) to decrease the rebound damping. Turn it to the right (B) to increase rebound damping.

NOTE: The rebound damping is factory set at 10 clicks from fully closed. See Suspension Settings on page 149.

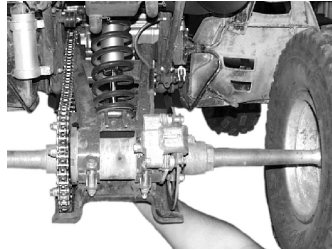

Step 1

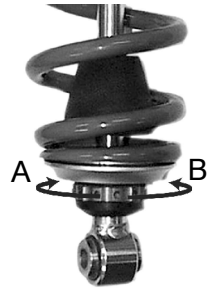

ADJUSTMENTS

Rear Suspension

Compression Damping

The compression damping clicker drum is located on top of the shock reservoir, under the left rear fender. It has eight possible positions ranging from position 1 (softest) to 8 (firmest). The compression damping is factory set at position 4. To adjust, turn the clicker drum to the desired setting. See Suspension Settings on page 149.

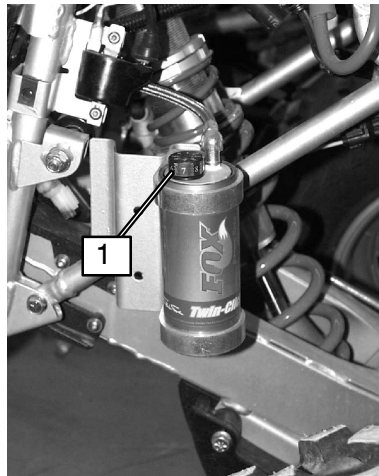

ADJUSTMENTS

Clutch Lever Freeplay

1. Measure clutch lever freeplay between the perch and the lever (A). This distance should be $1/8'' - 3/16''$ (3.1 mm - 4.7 mm).
2. If adjustment is required, slide the clutch perch pivot boot down the clutch cable to access the clutch adjustment screw (B) and lock ring (C).
3. Loosen the lock ring and turn the screw in (clockwise) to increase lever travel. Turn the screw out (counterclockwise) to decrease lever travel. Tighten the lock ring.
4. Squeeze the lever fully and release. Slightly squeeze the lever again until a slight resistance is felt. Measure the freeplay again. If necessary, repeat the adjustment procedure until proper freeplay is attained.
5. Replace the clutch perch pivot boot over the screw and lock ring.

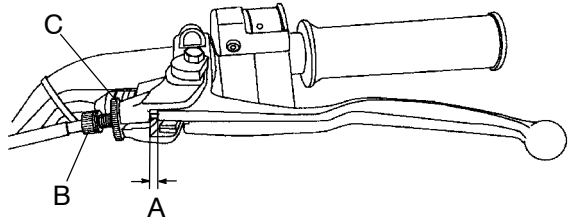

ADJUSTMENTS

Throttle Cable Freeplay

WARNING

Improper adjustment of throttle cable freeplay can result in loss of control, which could result in serious injury or death. Polaris recommends that this procedure be performed by a Polaris dealer to ensure that it's done correctly. Mechanically knowledgeable persons who perform this procedure must follow the adjustment procedures exactly.

Throttle cable freeplay is adjusted at the handlebar.

1. Slide the boots (1) off the inline cable adjuster sleeve (2) and loosen the adjuster locknut (3).
2. Turn the adjuster until $1/16''$ to $1/8''$ freeplay is achieved at the thumb lever.

NOTE: While adjusting freeplay, be sure to flip the throttle lever back and forth.

3. Tighten the locknut and slide the boots over the cable adjuster until they touch at the midpoint of the adjuster.

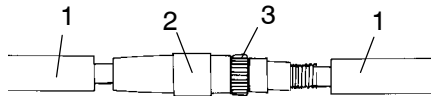

ADJUSTMENTS

Handlebars

If desired, the handlebars can be adjusted for rider preference.

⚠️ WARNING

Improper adjustment of the handlebars or incorrect torquing of the adjuster block bolts can cause limited steering or loosening of the handlebars, which could result in loss of control and serious injury or death. Follow the adjustment procedures exactly, or see your Polaris dealer for service.

1. Remove the instrument panel and locate the handlebar bolts (1).
2. Loosen the four bolts and adjust the handlebar to the desired height. Be sure the handlebars do not contact the gas tank or any other part of the machine when turned fully to the left or right.
3. Torque the front two bolts to 10-12 ft. lbs. (14-17 Nm), then torque the rear two bolts. A gap of up to 1/8" will remain at the rear bolts.

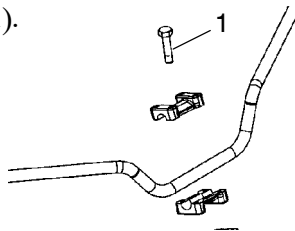

ADJUSTMENTS

Carburetor/Idle RPM

If the engine idle speed is not satisfactory, and all other conditions are favorable, the carburetor can be adjusted.

1. Warm up the engine by running the vehicle for five minutes, or until operating temperature is reached.
2. Apply the park brake and place the transmission in neutral.
3. Adjust the carburetor idle screw (1) either in or out until the desired idle RPM is reached. Turning the screw in (clockwise) will raise RPM. Turning the screw out (counterclockwise) will lower RPM.

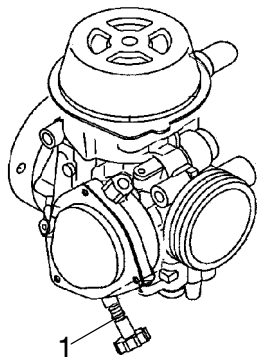

Carburetor/Idle RPM

If the vehicle is to be operated at various altitudes and temperatures, certain adjustments can be made to improve its operation and driveability. Above 6000 feet (1800 m) the engine air/fuel mixture becomes overly rich. An engine loses approximately 3% of its power for each 1000-foot (304.8 m) increase in elevation. Although this power cannot be regained, changes to the carburetor and drive system can be made to allow more efficient operation.

NOTE: Contact your dealer for altitude adjustments. Your dealer has the training and special tools required to perform these modifications.

- Carburetor re-jetting can be performed to compensate for altitude and/or temperature changes.

CLEANING AND STORAGE

See page 175 for the part numbers of Polaris products.

Cleaning the ATV

Keeping your ATV clean will not only improve its appearance but it can also extend the life of various components. With a few precautions, your ATV can be cleaned much like an automobile.

Washing the ATV

CAUTION

Do not use a high pressure washer for washing the ATV. Serious damage will result to wheel bearings, chains, transmission seals, body panels, brakes and decals.

The best and safest way to clean your ATV is with a garden hose and a pail of mild soap and water. Use a professional type washing mitten, cleaning the upper body first and the lower parts last. Rinse with water frequently and dry with a chamois to prevent water spots. **NOTE:** If warning and safety decals are damaged, contact your a Polaris dealer for free replacement. Grease all zerk fittings immediately after washing, and allow the vehicle to run for a while to evaporate any water that may have entered the engine or exhaust system.

CLEANING AND STORAGE

Waxing the ATV

Your ATV can be waxed with any non-abrasive automotive paste wax. Avoid the use of harsh cleaners since they can scratch the body finish.

CAUTION

Certain products, including insect repellants and chemicals, will damage plastic surfaces. Use caution when using these products near plastic surfaces.

CLEANING AND STORAGE

See page 175 for the part numbers of Polaris products.

Storage Recommendations

CAUTION

Starting the engine during the storage period will disturb the protective film created by fogging and damage could occur. Never start the engine during the storage period.

Clean the Exterior

Make necessary repairs and then clean the ATV thoroughly as outlined on page 160.

Stabilize the Fuel

Add Polaris Carbon Clean Fuel Treatment or Polaris Fuel Stabilizer to the fuel tank, following the instructions on the container for the recommended amount. Fill the fuel tank with fuel. Allow 15-20 minutes of operation for the stabilizer to disperse through the fuel in the tank and carburetor. Turn the fuel valve off and drain the carburetor bowl. **NOTE:** Carbon clean will also reduce the possibility of bacterial growth in the fuel system.

CLEANING AND STORAGE

Storage Recommendations

Oil and Filter

Warm the engine and change the oil and filter. See page 107.

Air Filter / Air Box

Inspect and clean or replace the pre-cleaner and air filter. Clean the air box and drain the sediment tube.

Breather Filter

Inspect and clean or replace the breather filter (inside the airbox).

Fluid Levels

Inspect all fluid levels and change as outlined in the Maintenance Schedule beginning on page 91.

Battery

Refer to pages 135-136 for battery storage and battery charging procedures.

CLEANING AND STORAGE

See page 175 for the part numbers of Polaris products.

Storage Recommendations

Fog the Engine

1. Start the engine and allow it to warm up. Turn engine off.
2. Unlatch and remove the seat.
3. Loosen the intake duct clamp at the carburetor and pull the duct off the carburetor.
4. Start the engine and spray Polaris fogging oil or a comparable product into the carburetor, following the instructions on the fogging oil container.
5. Turn the engine off, reassemble the intake duct to the carburetor, secure the clamp, and reinstall the seat.

CLEANING AND STORAGE

Storage Recommendations

Inspect and Lubricate

Inspect all cables and lubricate. Follow lubrication guidelines in the Maintenance Section of the service or owner's manual to completely grease and lubricate the entire vehicle with Polaris Premium All Season Grease.

Engine Anti-Freeze

Test engine coolant strength and add or change coolant if necessary. Replace coolant every two years.

Storage Area/Covers

Set the tire pressure and safely support the ATV with the tires 1-2" off the ground. Be sure the storage area is well ventilated, and cover the machine with a genuine Polaris ATV cover. **NOTE:** Do not use plastic or coated materials. They do not allow enough ventilation to prevent condensation, and may promote corrosion and oxidation.

CLEANING AND STORAGE

Transporting the ATV

Follow these procedures when transporting the vehicle.

1. Turn off the engine and remove the key to prevent loss during transporting.
2. Turn the fuel valve off.
3. Be sure the fuel cap, oil cap and seat are installed correctly.
4. Always tie the *frame* of the ATV to the transporting unit securely, as shown in the illustration, using suitable straps or rope.
5. Always place the transmission in first gear and lock the parking brake.

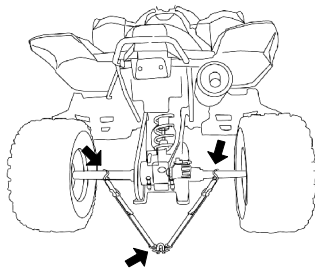
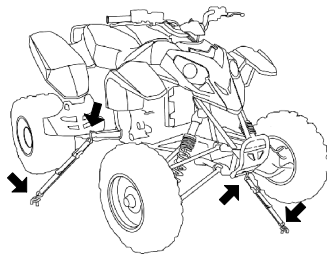

TROUBLESHOOTING

Contact your Polaris dealer for service if you're unable to identify solutions using the following charts.

Engine Doesn't Turn Over

Possible Cause	Solution
Fuseable link	See Polaris dealer for replacement
Low battery voltage	Recharge battery to 12.8 VDC
Loose battery connections	Check all connections and tighten
Loose solenoid connections	Check all connections and tighten

TROUBLESHOOTING

Engine Turns Over, Fails to Start

Possible Cause	Solution
Out of fuel	Turn fuel valve to reserve, refuel
Clogged fuel valve	Inspect and clean or replace
Water is present in fuel	Drain the fuel system and refuel
Fuel valve is turned off	Turn the fuel valve on
Old, poor or non-recommended fuel	Drain and replace with new fuel
Fouled or defective spark plug	Inspect plug(s), replace if necessary
No spark to spark plug	Inspect plug(s), verify stop switch is on
Overuse of choke	Inspect, clean and/or replace spark plugs
Low battery voltage	Recharge battery to 12.8 VDC
Mechanical failure	See your Polaris dealer
Throttle ETC switch not opening	Adjust throttle freeplay

TROUBLESHOOTING

Engine Pings or Knocks

Possible Cause	Solution
Poor quality or low octane fuel	Replace with recommended fuel
Incorrect ignition timing	See your Polaris dealer
Incorrect spark plug gap or heat range	Set gap to specs or replace plugs

Engine Backfires

Possible Cause	Solution
Weak, fouled or defective spark plug	Inspect, clean and/or replace spark plugs
Incorrect spark plug gap or heat range	Set gap to specs or replace plugs
Old, poor or non-recommended fuel	Replace with new fuel
Incorrectly installed spark plug wire	See your Polaris dealer
Incorrect ignition timing	See your Polaris dealer
Mechanical failure	See your Polaris dealer

TROUBLESHOOTING

Engine Runs Irregularly, Stalls or Misfires

Possible Cause	Solution
Fouled or defective spark plug	Inspect, clean and/or replace spark plugs
Worn or defective spark plug wire	See your Polaris dealer
Incorrect spark plug gap or heat range	Set gap to specs or replace plugs
Loose ignition connections	Check all connections and tighten
Water present in fuel	Replace with new fuel
Low battery voltage	Recharge battery to 12.8 VDC or replace
Kinked or plugged fuel tank vent line	Inspect and replace
Old, poor or non-recommended fuel	Replace with recommended fuel
Clogged air filter	Inspect and clean or replace
Electronic throttle control (ETC) malfunction	See your Polaris dealer
Other mechanical failure	See your Polaris dealer

TROUBLESHOOTING

Engine Runs Irregularly, Stalls or Misfires

Possible Lean Fuel Mixture Cause	Solution
Low or contaminated fuel	Add or change fuel, clean the fuel system
Low octane fuel	Replace with recommended fuel
Old, poor or non-recommended fuel	Replace with recommended fuel
Clogged fuel valve screen	See your Polaris dealer
Incorrect jetting	See your Polaris dealer
Possible Rich Fuel Mixture Cause	Solution
Overuse of choke	Inspect, clean and/or replace spark plugs
Fuel is very high octane	Replace with recommended lower octane fuel
Incorrect jetting	See your Polaris dealer
Plugged, dirty or wet air filter	Clean pre-filter, replace main filter as needed

TROUBLESHOOTING

Engine Stops or Loses Power

Possible Cause	Solution
Out of fuel	Turn fuel valve to reserve, refuel
Kinked or plugged fuel vent line	Inspect and replace
Water present in fuel	Replace with new fuel
Overuse of choke	Inspect, clean and/or replace spark plugs
Fouled or defective spark plug	Inspect, clean and/or replace spark plugs
Worn or defective spark plug wire	See your Polaris dealer
Incorrect spark plug gap or heat range	Set gap to specs or replace plugs
Loose ignition connections	Check all connections and tighten
Low battery voltage	Recharge battery to 12.8 VDC or replace
Old, poor or non-recommended fuel	Replace with recommended fuel

TROUBLESHOOTING

Engine Stops or Loses Power

Possible Cause	Solution
Clogged, dirty or wet air filter	Inspect and clean or replace
Electronic throttle control (ETC) malfunction	See your Polaris dealer
Other mechanical failure	See your Polaris dealer
Overheated engine	Clean radiator screen and core if equipped Clean engine exterior See your Polaris dealer

Engine Overheating

Possible Cause	Solution
Debris lodged in screen	Remove and clean the screen.
Plugged radiator	Use a garden hose to flush any debris from the radiator fins. NOTE: High pressure washers can deform the radiator fins and reduce cooling efficiency.

NOTES

POLARIS PRODUCTS

Part #	Description	Part #	Description
Engine Lubricant		Coolant	
2874414	Performance Synthetic 4-Stroke (PS-4) Oil (qt.)	2871323	60/40 Coolant (gal.)
2874415	PS-4 Oil (gal.)	2871534	60/40 Coolant (qt.)
Grease / Specialized Lubricants		Additives / Miscellaneous	
2871312	Grease Gun Kit, Premium All Season (3 oz.)		
2871322	Premium All Season Grease (3 oz. cartridge)	2871326	Carbon Clean Plus (12 oz.)
2871423	Premium All Season Grease (14 oz. cartridge)	2870652	Fuel Stabilizer (16 oz.)
2871460	Starter Drive Grease (2 oz.)	2870990	DOT3 Brake Fluid (12 oz.)
2871329	Dielectric Grease (Nyogel™)	2872893	Engine Degreaser (12 oz.)
2872073	Chain Lube (6.25 oz. aerosol)		
2872348	Chain Lube (16 oz. aerosol)		

SPECIFICATIONS

Predator 500

Gross Vehicle Weight	645 lbs./292 kg	Pilot Jet	45
Fuel Capacity	3.25 gal./12.3 l	Main Jet	150
Overall Length	71.5 in./182 cm	Needle Jet	O-OM
Overall Width	47.5 in./121 cm	Jet Needle	6CGY07-060-3
Overall Height	45 in./114 cm	Alternator Output	200 w @ 3000 RPM
Wheelbase	51 in./130 cm	Compression Ratio	10.8:1
Ground Clearance	4.5 in./11 cm	Starting System	Electric
Dry Weight	415 lbs./188 kg	Carburetor	BSR 42mm
Minimum Turning Radius	67 in./170 cm	Ignition System	CDI
Engine Oil Capacity	2.25 qts./2.1 l	Ignition Timing	30° ± 3° @ 3500 RPM
Coolant Capacity	2.25 qts./2.1 l	Spark Plug / Gap	NGK DCPR8E / 0.9 mm / .035 in.
Engine	ES50PLX	Lubrication System	Dry Sump
Displacement	499 cc		
Bore x Stroke	99.2 x 64.6 mm		

SPECIFICATIONS

Predator 500				
Driving System Type	Rear Two-Wheel Drive		Tire Size/Pressure - Front	21 x 7 - 10 / 4 psi
Shift Type	5-Speed Manual Shift		Tire Size/Pressure - Rear	20 x 11 - 9 / 4 psi
Drive Ratio - Final	14/37		Front Brake	Hydraulic Disc
Gear Ratio - 1st	2.6		Rear Brake	Hydraulic Disc
Gear Ratio - 2nd	1.7		Parking Brake	Hydraulic lock, front wheel
Gear Ratio - 3rd	1.3		Headlights	2 - Dual Beam (35w/35w)
Gear Ratio - 4th	1.1		Taillights	8.26w
Gear Ratio - 5th	0.9		Brakelight	26.9w

Jetting Chart

Altitude	AMBIENT TEMPERATURE	Below 40° F (Below 5° C)	+40° F and above (+5° C and above)
Meters (Feet)	0-1800 (0-6000)	155	150
	1800-3700 (6000-12000)	147.5	142.5

WARRANTY

LIMITED WARRANTY

Polaris Sales Inc., 2100 Highway 55, Medina, MN 55340, gives a **SIX MONTH LIMITED WARRANTY** on all components of the Polaris All Terrain Vehicle (ATV) against defects in material or workmanship. Polaris also gives a one year limited warranty on the final drive chain for failure due to defects. This warranty covers the parts and labor charges for repair or replacement of defective parts which are covered by this warranty. This warranty begins on the date of purchase. This warranty is transferrable to another consumer during the warranty period through a Polaris dealer.

REGISTRATION

At the time of sale, the Warranty Registration Form must be completed by your dealer and submitted to Polaris within ten days. Upon receipt of this registration, Polaris will record the registration for warranty. **THE PURCHASER MUST COMPLETE AN ATV SAFETY TRAINING COURSE PROVIDED BY THE DEALER IN ORDER TO HAVE VALID WARRANTY ON THE ATV.** No verification of registration will be sent to the purchaser as the copy of the Warranty Registration Form will be the warranty entitlement. If you have not signed the original registration and received the “customer copy”, please contact your dealer immediately. **NO WARRANTY COVERAGE WILL BE ALLOWED UNLESS YOUR ATV IS REGISTERED WITH POLARIS.**

Initial dealer preparation and set-up of your ATV is very important in ensuring trouble-free operation. Purchasing a machine in the crate or without proper dealer set-up will void your warranty coverage.

WARRANTY

WARRANTY COVERAGE AND EXCLUSIONS: LIMITATIONS OF WARRANTIES AND REMEDIES

The Polaris limited warranty excludes any failures that are not caused by a defect in material or workmanship. This warranty does not cover accidental damage, normal wear and tear, abuse or improper handling. This warranty also does not cover any ATV that has been altered structurally, modified, neglected, improperly maintained, used for racing, or used for purposes other than for which it was manufactured, or for any damages which occur during trailer transit or as a result of unauthorized service or the use of unauthorized parts. In addition, this warranty does not cover physical damage to paint or finish, stress cracks, tearing or puncturing of upholstery material, corrosion, or defects in parts, components or the ATV due to fire, explosions or any other cause beyond Polaris' control.

This warranty does not cover the use of unauthorized lubricants, chemicals, or fuels that are not compatible with the ATV. The exclusive remedy for breach of this warranty shall be, at Polaris' exclusive option, repair or replacement of any defective materials, or components or products. **THE REMEDIES SET FORTH IN THIS WARRANTY ARE THE ONLY REMEDIES AVAILABLE TO ANY PERSON FOR BREACH OF THIS WARRANTY. POLARIS SHALL HAVE NO LIABILITY TO ANY PERSON FOR INCIDENTAL, CONSEQUENTIAL OR SPECIAL DAMAGES OF ANY DESCRIPTION, WHETHER ARISING OUT OF EXPRESS OR IMPLIED WARRANTY OR ANY OTHER CONTRACT, NEGLIGENCE, OR OTHER TORT OR OTHERWISE.** Some states do not permit the exclusion or limitation of incidental or consequential damages or implied warranties, so the above limitations or exclusions may not apply to you if inconsistent with controlling state law.

WARRANTY

WARRANTY COVERAGE AND EXCLUSIONS: LIMITATIONS OF WARRANTIES AND REMEDIES

ALL IMPLIED WARRANTIES (INCLUDING BUT NOT LIMITED TO THE IMPLIED WARRANTIES OF MERCHANTABILITY AND FITNESS FOR A PARTICULAR PURPOSE) ARE LIMITED IN DURATION TO THE ABOVE SIX MONTH WARRANTY PERIOD. POLARIS FURTHER DISCLAIMS ALL EXPRESS WARRANTIES NOT STATED IN THIS WARRANTY. Some states do not allow limitations on how long an implied warranty lasts, so the above limitation may not apply to you if inconsistent with controlling state law.

WARRANTY

HOW TO OBTAIN WARRANTY SERVICE

If your ATV requires warranty service, you must take it to a Polaris dealer authorized to repair Polaris ATVs. When requesting warranty service you must present your copy of the Warranty Registration form to the dealer. (THE COST OF TRANSPORTATION TO AND FROM THE DEALER IS YOUR RESPONSIBILITY). Polaris suggests that you use your original selling dealer; however, you may use any Polaris Servicing Dealer to perform warranty service.

Please work with your dealer to resolve any warranty issues. Should your dealer require any additional assistance they will contact the appropriate personnel at Polaris.

This warranty gives you specific legal rights, and you may also have other rights which vary from state to state.

If any of the above terms are void because of state or federal law, all other warranty terms will remain in effect.

Engine Oil

1. Mixing oil brands or using non-recommended oil may cause engine damage. We recommend the use of Polaris engine oil.
2. Damage resulting from the use of non-recommended lubricants may not be covered by warranty.

WARRANTY

Exported Vehicles

EXCEPT WHERE SPECIFICALLY REQUIRED BY LAW, THERE IS NO WARRANTY OR SERVICE BULLETIN COVERAGE ON THIS VEHICLE IF IT IS SOLD OUTSIDE THE COUNTRY OF THE SELLING DEALER'S AUTHORIZED LOCATION.

This policy does not apply to vehicles that have received authorization for export from Polaris Industries. Dealers may not give authorization for export. You should consult an authorized dealer to determine this vehicle's warranty or service bulletin coverage if you have any questions.

This policy does not apply to vehicles registered to government officials or military personnel on assignment outside the country of the selling dealer's authorized location.

This policy does not apply to Safety Recalls.

Exported Vehicles

How to Get Service

In the Country where your vehicle was purchased:

Warranty or Service Bulletin repairs must be done by an authorized Polaris dealer. If you move or are traveling within the country where your vehicle was purchased, Warranty or Service Bulletin repairs may be requested from any authorized Polaris dealer who sells the same line as your vehicle.

Outside the Country where your vehicle was purchased:

If you are traveling temporarily outside the country where your vehicle was purchased, you should take your vehicle to an authorized Polaris dealer. You must show the dealer photo identification from the country of the selling dealer's authorized location as proof of residence. Upon residence verification, the servicing dealer will be authorized to perform the warranty repair.

If You Move:

If you move to another country, be sure to contact Polaris Customer Assistance and the customs department of the destination country before you move. Vehicles importation rules vary considerably from country to country. You may be required to present documentation of your move to Polaris Industries in order to continue your warranty coverage. You may also be required to obtain documentation from Polaris Industries in order to register your vehicle in your new country.

WARRANTY

Exported Vehicles

How to Get Service

If Purchased From A Private Party:

If you purchase a Polaris product from a private citizen outside of the country in which the vehicle was originally purchased, all warranty coverage will be denied.

Notice

If your vehicle is registered outside of the country where it was purchased, and you have not followed the procedure set out above, your vehicle will no longer be eligible for warranty or service bulletin coverage of any kind. (Vehicles registered to Government officials or military personnel on assignment outside of the country where the vehicle was purchased will continue to be covered by the basic warranty.)

For questions call Polaris Customer Assistance:

United States: 1-763-417-8650

Canada: 1-204-925-7100

Index

A

- ADJUSTMENTS 142-159
- Air Filter Systems 112-113

B

- Battery 134
- Battery Charging 136-137
- Battery Installation 135
- Battery Removal 134
- Battery Storage 135
- Brake Fluid 60
- Brake Levers 59
- Brakes 142-143
- Break-In Period 70-71

C

- Cab Removal, Front 124
- Cab Removal, Rear 123
- Camber and Caster 149
- Carburetor/Idle RPM 158-159
- Chain Tension 146-148
- Choke 64
- CLEANING AND STORAGE . 160-166
- Clutch Lever 57
- Clutch Lever Freeplay 155
- Compression Damping 154

C

- Coolant Level, Radiator 116
- Coolant Level, Recovery Bottle . . . 115
- Cooling System 114-115

D

- Driving Across Hills 81
- Driving Downhill 84
- Driving on Slippery Surfaces 79
- Driving Over Obstacles 88
- Driving Procedures 77
- Driving Safely 77-88
- Driving Through Water 86-87
- Driving Uphill 80

E

- Electrical Switches 52-53
- Electronic Throttle Control 57
- Engine Cooling System 116
- Engine Oil Level 105-106
- Equipment Modifications 23

F

- FEATURES AND CONTROLS .. 52-68
- Foot Brake 58

F

- Front Suspension 150-151
- Fuel Filter 64
- Fuel Safety 69
- Fuel Tank 64
- Fuel Valve 63

H

- Handlebars 157
- Headlight Adjustment 122
- Headlight Assembly
Replacement 119-120
- Headlight Lamp Replacement 118

J

- Jetting Chart 177

K

- K-turn 82

L

- Light Switches 55
- Lights 54, 117-122
- Lubrication Points 97
- Lubrication Recommendations 104

Index

M

MAINTENANCE AND LUBRICATION 91-141
Maintenance Record 102-103
Making Turns 78
Manual Shift 65-68
Master Cylinder 60

N

NOISE CONTROL SYSTEM 89-90

O

Oil Change 107-111
Oil Filter Change 107-111
Oil Level 105-106
OPERATION 69-88
Operator Restrictions 14
Operator Safety 14-51

P

Parking Brake 61-62
Parking on an Incline 85
Periodic Maintenance Schedule . 91-100
POLARIS PRODUCTS 175
Pre-Ride Inspection 72-73

R

Rear Suspension 152-154
Rebound Damping 153

S

Safe Riding Gear 12-13
SAFETY 8-51
Safety Decals and Locations 8-11
Safety Training 15
Setting the Parking Brake 61
Shift Pedal 65
Shifting 67
Side Panel Removal 123
Spark Arrestor 90, 130-131
Spark Plug Removal and Replacement 127-129
Spark Plugs 125-129
SPECIFICATIONS 176-177
Spring Preload 151-152
Starting a Cold Engine 74-75
Starting a Warm Engine 76
Steering Assembly 149
Storage Recommendations 162-165
Suspension Adjustments 150-154
Suspension Settings 149

T

TABLE OF CONTENTS 5
Taillight/Brakelight Lamp Replacement 121
Throttle Cable Freeplay 156
Throttle Lever 56
Tires 138-139
Toe Alignment 144-145
Transporting the ATV 166
TROUBLESHOOTING 167-173
Turning Around on a Hill 82-83

U

USFS Approved Spark Arrestor 90

V

VEHICLE IDENTIFICATION NUMBERS 6-7
Vehicle Immersion 132-133

W

WARRANTY 178-180
WELCOME 3-4
Wheel Installation 140
Wheel Nut Torque Specifications .. 141
Wheel Removal 139