

**VICTORY**



**FUEL IT.**

# **2011 Rider's Manual**

**Victory Cross Roads™  
Victory Cross Country™**

**California Proposition 65 Warning**

This product contains or emits  
chemicals known to the state of  
California to cause cancer and birth  
defects or other reproductive harm.



The text is printed on 100% recycled  
with 40% post-consumer waste (PCW).



For your nearest VICTORY dealer,  
call 1-800-POLARIS  
or visit [www.polarisindustries.com](http://www.polarisindustries.com)  
Polaris Sales Inc.,  
2100 Hwy. 55, Medina, MN 55340  
Phone 1-888-704-5290  
Part No. 9923026 Rev 01  
Printed in USA



**FUEL IT.** |  **VICTORY.**

## **2011 Rider's Manual**

**Victory Cross Roads™**  
**Victory Cross Country™**

Copyright© 2010 Polaris Sales Inc.

All information contained within this publication is based on the latest product information available at the time of publication. Product improvements or other changes may result in differences between this manual and the motorcycle. Depictions and/or procedures in this publication are intended for reference use only.

No liability can be accepted for omissions or inaccuracies. Polaris Industries reserves the right to make changes at any time, without notice and without incurring obligation to make the same or similar changes to motorcycles previously built. Any reprinting or reuse of the depictions and/or procedures contained within, whether whole or in part, is expressly prohibited.

All reference to RIGHT, LEFT, FRONT, REAR are from the operator's perspective seated in a normal riding position.

Features of VICTORY Motorcycles are covered by U.S. Patent Nos: 6,976,691; 6,407,663; D489670; D482311; D482304; D481980; D481973; D474142.

The following are registered trademarks of Polaris Industries Inc.:

POLARIS®, THE WAY OUT®, FREEDOM®, VICTORY® and VICTORY MOTORCYCLES®.

VICTORY CROSS ROADS™ and VICTORY CROSS COUNTRY™ are trademarks of Polaris Industries Inc.

DUNLOP® is a registered trademark of Dunlop Tire Corporation.

LOCTITE® is a registered trademark of Henkel Corporation.

XM Ready® is a registered trademark of XM® Satellite Radio Inc. All rights reserved.

iPod® is a registered trademark of Apple Inc.

Garmin® and zumo® are trademarks of Garmin Ltd. or its subsidiaries.

Printed in U.S.A.

P/N 9923026

# Table of Contents

Introduction . . . . .	4
Safety . . . . .	5
Reporting Safety Defects . . . . .	15
Component Identification . . . . .	16
Instruments, Features & Controls. . . . .	19
Pre-Ride Inspections . . . . .	36
Operation . . . . .	44
Maintenance. . . . .	53
Cleaning and Storage. . . . .	85
Warranty. . . . .	93
Specifications . . . . .	97
Audio System . . . . .	100
System Overview . . . . .	100
System Operation . . . . .	102
CB Radio / Intercom (ICOM). . . . .	109
AUX / iPod. . . . .	113
XM Radio. . . . .	115
NAV MP3. . . . .	118
Index . . . . .	119

# Introduction

Thank you for purchasing a Polaris vehicle, and welcome to our world-wide family of Polaris owners. We proudly produce an exciting line of utility and recreational products.

- Snowmobiles
- All-terrain vehicles (ATVs)
- *RANGER* utility vehicles
- Low emission vehicles (LEVs)
- VICTORY MOTORCYCLES

For the safe and enjoyable operation of your vehicle, be sure to follow the instructions and recommendations in this rider's manual. Keep this manual with the motorcycle, especially when ownership changes. If your rider's manual is misplaced or damaged, please purchase a replacement from your VICTORY dealer.

All references in this manual to RIGHT, LEFT, FRONT or REAR are from the operator's perspective when seated in a normal riding position. If you have questions about the operation or maintenance of your motorcycle after you've read this manual, please see your VICTORY dealer. To locate the nearest authorized VICTORY dealer, call 1-800-POLARIS or visit [www.polarisindustries.com](http://www.polarisindustries.com).

VICTORY motorcycles comply with all federal, state and local safety and emission regulations for the area of intended sale.



## About the Rider's Manual

### **WARNING**

Failure to follow recommended precautions and procedures could result in severe injury or death. Always heed all safety precautions and follow all operation, inspection and maintenance procedures outlined in this manual.

This rider's manual contains information that is essential to safe riding and proper maintenance of your VICTORY motorcycle. Anyone who uses the motorcycle (operators and passengers) must read the rider's manual before riding. Carefully read and understand the information found in the *Safety* section. Understand and follow the procedures outlined in the *Maintenance* section to keep your VICTORY motorcycle in top condition on the road or in storage. Bring the manual with you when you ride. Following the precautions and procedures in the manual will add to your enjoyment and help keep you riding safely. If you lose or damage this manual, you can purchase a new one through any authorized VICTORY dealer. The rider's manual should be considered part of the motorcycle and remain with it if sold.

## Safety Symbols and Signal Words

The following signal words and symbols appear throughout this manual. Your safety and the safety of others is involved when these words and symbols are used. Become familiar with their meanings before reading the manual.



The safety alert symbol indicates a potential for personal injury.

### **WARNING**

WARNING indicates a hazardous situation which, if not avoided, could result in death or serious injury.

### **CAUTION**

CAUTION indicates a hazardous situation which, if not avoided, could result in minor or moderate injury.

### **NOTICE**

NOTICE indicates a situation that may result in property damage.

# Safety

## Safe Riding Practices

### **WARNING**

Improper use of this motorcycle can result in serious injury or death to you, your passenger and others. To minimize the risk of injury, read and understand the information contained in this section before operating the motorcycle. This section contains safety information specific to the VICTORY motorcycle, as well as information about general motorcycle safety. Anyone who rides the motorcycle (operators and passengers) must follow these safety precautions.

### **Motorcycling has inherent risks.**

You can minimize those risks, but you can't eliminate them completely. Even if you're an experienced motorcycle operator or passenger, read all of the safety information in this manual before operating the motorcycle.

- Take a rider education course from the Motorcycle Safety Foundation or another qualified instructor. The course will help you develop or refresh your expertise in safe riding habits through instruction and riding. For information on Motorcycle Safety Foundation rider education courses in your area, call 1-800-446-9227 or visit their home page at [www.msfsa.org](http://www.msfsa.org).
- Read and understand all information in this rider's manual.
- Observe all maintenance requirements specified in this manual. For assistance, see the *VICTORY Service Manual* or your authorized VICTORY dealer.

### **Design characteristics affect how you should ride the VICTORY motorcycle:**

- The motorcycle is designed for on-road use with one rider and one passenger. See the manufacturer's label (on the left side of the frame at the steering head). The label contains the Vehicle Identification Number (VIN) and Gross Vehicle Weight Rating (GVWR) and Gross Axle Weight Rating (GAWR) information. *Never exceed the GVWR or the GAWR.*
- Riding off-road, riding with more than one passenger, or carrying weight exceeding the maximum weight rating can make handling difficult, which could cause loss of control.
- During the first 500 miles (800 km) of operation, follow all break-in procedures as outlined in the break-in section beginning on page 44. Failure to do so can result in serious engine damage.
- Some VICTORY motorcycles include saddlebags, a windshield, a trunk, or a passenger backrest as standard equipment. To maintain stability, be prepared to reduce the operating speed of motorcycles equipped with these items.

## Safe Riding Practices

### Follow these general safe riding practices:

- Before each ride, perform the pre-ride inspections as outlined beginning on page 36. Failure to do so may result in damage to the motorcycle or an accident.
- Until you're thoroughly familiar with the motorcycle and all of its controls, practice riding where there is little or no traffic. Practice riding at a moderate speed on various road surfaces and in different weather conditions.
- Know your skills and limits, and ride within them.
- Allow only licensed, experienced operators to ride your motorcycle, and then only after they have become familiar with its controls and operation. Make sure all riders read and understand this rider's manual before riding.
- Do not ride when you're fatigued or under the influence of alcohol, prescription drugs, over-the-counter drugs or any other drugs. Fatigue, alcohol and drugs can cause drowsiness, loss of coordination and loss of balance. They can also affect your awareness and judgment.
- If your motorcycle operates abnormally, correct the problem immediately. See the *VICTORY Service Manual* or an authorized VICTORY dealer.
- Ride defensively, as if you are invisible to other motorists, even in broad daylight. *A motorist's failure to see or recognize a motorcycle is the leading cause of automobile/motorcycle accidents.* Ride where you're clearly visible to other motorists, and observe their behavior carefully.
- Be especially cautious at intersections, as these are the most likely places for an accident.
- To prevent loss of control, keep your hands on the handlebars and your feet on the footrests.
- Be aware that the highway bar is not designed to protect the rider from injury in a collision.
- Do not move or operate the motorcycle with the steering locked (if equipped), as the severely restricted steering could result in loss of control.
- Obey the speed limit and adjust your speed and riding technique based on road, weather and traffic conditions. As you travel faster, the influence of all other conditions increases, which can affect the motorcycle's stability and increase the possibility of losing control.

# Safety

## Safe Riding Practices

- Reduce speed when:
  - the road has potholes, or is otherwise rough or uneven.
  - the road contains sand, dirt, gravel or other loose substances.
  - the road is wet, icy or oily.
  - the road contains painted surfaces, manhole covers, metal grating, railway crossings or other slippery surfaces.
  - The weather is windy, rainy or otherwise causing slippery or rapidly changing conditions.
  - Traffic is heavy, congested, not allowing sufficient space between vehicles or otherwise not flowing smoothly.
  - You are being passed in either direction by a large vehicle that produces a wind blast in its wake.
- To maximize braking effectiveness, *use the front and rear brakes together*. Be aware of the following braking facts and practices:
  - The rear brake provides 40% of the motorcycle's stopping power, at most. Use the front and rear brakes together.
  - To avoid skidding, apply the brakes gradually when the road is wet or rough, or contains loose or other slippery substances.
  - If possible, avoid applying the brakes while making a turn. Motorcycle tires have less traction during turns, so braking will increase the possibility of skidding. Bring the motorcycle to the upright position before applying the brakes.
- When approaching a curve, choose a speed and lean angle that allows you to pass through the curve in your own lane without applying the brakes. Excessive speed, improper lean angle or braking in a curve can cause loss of control.
- Ground clearance is reduced when the motorcycle leans. Do not allow components to contact the road surface when leaning the motorcycle in a curve, as this could cause loss of control.
- Retract the sidestand fully before riding. If the sidestand is not fully retracted, it could contact the road surface and cause loss of control.
- Do not tow a trailer. Towing a trailer can make the motorcycle hard to handle.

## Safe Riding Practices

### Carrying a Passenger

*Do not carry a passenger unless the motorcycle is equipped with passenger seat and passenger footrests.*

#### To carry a passenger safely:

- Do not exceed the gross vehicle weight rating (GVWR) for your motorcycle.
- Direct the passenger to hold onto you or to the passenger hand grips with both hands and to keep both feet on the passenger footrests. Do not carry a passenger who cannot place both feet firmly on the passenger footrests. A passenger who is not holding on properly, or who cannot reach the passenger footrests, can shift their body erratically, which can make the motorcycle hard to handle and cause loss of control.
- To obtain the best ride and handling characteristics, adjust the rear shock absorber air pressure. See page 64.
- Before riding, be sure your passenger knows safe riding procedures. Discuss any safety information unfamiliar to your passenger. A passenger who is unaware of safe riding procedures may distract you or make movements that make the motorcycle hard to handle.
- Adjust your riding style to compensate for the differences in handling, acceleration and braking caused by the additional weight of the passenger. Failure to do so can cause loss of control.

### Protective Apparel

Wear protective apparel to decrease the risk of injury and increase riding comfort.

- Always wear a helmet that meets or exceeds established safety standards. Approved helmets in the USA and Canada bear a U.S. Department of Transportation (DOT) label. Laws in some areas *require* that you wear an approved helmet. Head injuries are the leading cause of fatalities in accidents involving motorcycles. Statistics prove that an approved helmet is the most effective protection in preventing or reducing head injuries.
- Wear eye protection to protect eyes from wind or airborne particles and objects. Laws in some areas *require* that you wear eye protection. VICTORY recommends that you wear approved Personal Protective Equipment (PPE) bearing markings such as VESC 8, V-8, Z87.1, or CE. Make sure protective eyewear is kept clean.
- All riders should wear bright or light-colored and/or reflective clothing to improve visibility to other motorists. *A motorist's failure to see or recognize a motorcycle is the leading cause of automobile/motorcycle accidents.*
- Wear gloves, a jacket, heavy boots and long pants to prevent or reduce injury from abrasions, lacerations or burns should the motorcycle fall. Wear boots with low heels, as high heels can catch on pedals or footrests. The combination of boots and pants should completely cover legs, ankles and feet, protecting skin from engine and exhaust system heat.
- Do not wear loose, flowing clothing or long boot laces, as they can catch on handlebars, levers or footrests, or they can become entangled in the wheels, causing loss of control and serious injury.

# Safety

## Use of Accessories

Because VICTORY cannot test and make specific recommendations concerning every accessory or combination of accessories sold, the operator is responsible for determining that the motorcycle can be safely operated with any accessories or additional weight. Use the following guidelines when choosing and installing accessories:

- Do not install accessories that impair the stability, handling or operation of the motorcycle. Before installing an accessory, be sure that it does not:
  - Reduce ground clearance when the motorcycle is either leaned or in a vertical position.
  - Limit suspension or steering travel or your ability to operate controls.
  - Displace you from your normal riding position.
  - Obscure lights or reflectors.
- Bulky or large accessories can cause instability (due to the lifting or buffeting effects of wind) and loss of control.
- Do not install electrical accessories that exceed the capacity of the motorcycle's electrical system. Never install higher wattage light bulbs than those supplied as original equipment. An electrical failure could result and cause hazardous loss of engine power or lights, or damage to the electrical system. See page 81.
- Use only genuine VICTORY accessories designed for your model.

## Modifications

Modifying the motorcycle by removing any equipment or by adding equipment not approved by VICTORY may void your warranty. Such modifications could make the motorcycle unsafe to ride and could result in severe injury to operator or passengers, as well as damage to the motorcycle. Some modifications may not be legal in your area of operation. If in doubt, contact your authorized VICTORY dealer.

## Parking the Motorcycle

When leaving the motorcycle unattended, turn the engine off. Remove the ignition key to prevent unauthorized use.

Park the motorcycle where people are not likely to touch the hot engine or exhaust system or place combustible materials near these hot areas. Do not park near a flammable source such as a kerosene heater or an open flame, where hot components could ignite combustible materials.

Park the motorcycle on a firm, level surface. Sloped or soft surfaces may not support the motorcycle. If you must park on a slope or soft surface, follow the precautions outlined on page 51.

## Carrying Cargo

Use the following guidelines when attaching cargo or accessories to the motorcycle. Where applicable, these guidelines also refer to the contents of any accessories.

- Keep cargo and accessory weight to a minimum, and keep items as close to the motorcycle as possible to minimize a change in the motorcycle's center of gravity. Changing the center of gravity can cause loss of stability and handling and could cause loss of control.
- Distribute weight evenly on both sides of the motorcycle. Maintain even weight distribution by checking accessories and cargo to make sure they're securely attached to the motorcycle before riding and whenever you take a break from riding. Uneven weight distribution, or accessories or cargo that shift suddenly while you're riding can make the motorcycle hard to handle and could cause loss of control.
- Do not attach large or heavy cargo such as sleeping bags, duffel bags or tents to the handlebars, front fork area or front fender. Cargo or accessories placed in these areas can cause instability (due to improper weight distribution or aerodynamic changes) and could cause loss of control. Such items can also block air flow to the engine and cause overheating that can damage the engine.
- Do not exceed the maximum cargo weight limit of any accessory (see accessory instructions and labels). Do not attach cargo to an accessory not designed for that purpose. Either circumstance could result in an accessory failure that could cause loss of control.
- Do not attach anything to the motorcycle unless specifically designed for that purpose by VICTORY.

## Saddlebags

**WARNING!** Operating this vehicle without saddlebags could result in severe injury or death. Never operate this vehicle if the saddlebags are not in place and properly secured.

Whenever operating a motorcycle with saddlebags:

- Never ride at excessive speeds. Depending on load and weather conditions, the maximum safe operating speed may be less. Saddlebags, combined with the lifting or buffeting effects of wind, can make the motorcycle unstable and cause loss of control.
- Distribute weight evenly in each of the saddlebags.
- Do not exceed the individual weight limit of each saddlebag. A weight capacity label is attached inside for reference.
- **NEVER EXCEED GROSS VEHICLE WEIGHT RATING (GVWR) or the GROSS AXLE WEIGHT RATING (GAWR)**, regardless of whether or not the saddlebags are loaded to capacity. Exceeding the weight rating can reduce stability and handling and cause loss of control.

# Safety

## Transporting the Motorcycle

If you must transport the motorcycle:

- Use a truck or trailer. Do not tow the motorcycle with another vehicle, as towing will impair the motorcycle's steering and handling.
- Position and restrain the motorcycle so it remains upright on the truck or trailer. If the motorcycle leans to one side, gasoline may leak from the fuel tank and result in a fire hazard or damage to the finish.
- Do not restrain the motorcycle using the handlebars.
- Place tiedown straps around the fork tubes above the lower triple clamp. Place tiedowns as wide apart as possible on the truck or trailer bed for best stability.

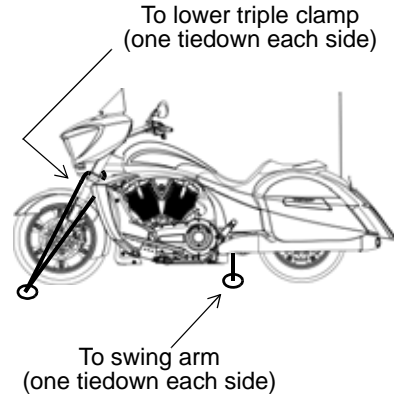

## Fuel and Exhaust Safety

Always heed these fuel safety warnings when refueling or servicing the fuel system. For fueling procedures, see page 45.

### **▲ WARNING**

Gasoline is highly flammable and explosive under certain conditions.

- Always exercise extreme caution whenever handling gasoline.
- Always turn off the engine before refueling.
- Always refuel outdoors or in a well-ventilated area.
- Open the fuel cap slowly. Do not overfill the tank. Do not fill the tank neck.
- Do not smoke or allow open flames or sparks in or near the area where refueling is performed or where gasoline is stored.

Gasoline and gasoline vapors are poisonous and can cause severe injury.

- Do not swallow gasoline, inhale gasoline vapors, or spill gasoline. If you swallow gasoline, inhale more than a few breaths of gasoline vapor, or get gasoline in your eyes, see a physician immediately.
- If gasoline spills on your skin or clothing, immediately wash it off with soap and water and change clothing.

Exhaust gases contain carbon monoxide, a colorless, odorless gas that can cause loss of consciousness or death in a short time.

- Never start the engine or let it run in an enclosed area.
- Never inhale exhaust gases.



## Safety Maintenance

### WARNING

Failure to perform safety maintenance as recommended can result in difficult handling and loss of control, which could result in serious injury or death. Always perform the safety maintenance procedures as recommended. Perform maintenance and repairs promptly as outlined in the VICTORY service manual, or see your authorized VICTORY dealer for service.

- Before each ride, perform the Pre-Ride Inspections. See page 36.
- Perform all periodic maintenance at the recommended intervals outlined in the Periodic Maintenance section beginning on page 54.
- Always maintain proper tire pressure, tread condition and wheel and tire balance. Inspect tires regularly and replace worn or damaged tires promptly. Use only approved replacement tires.
- Always ensure proper steering head bearing adjustment. Regularly inspect the rear shock absorber and the front forks for fluid leaks or damage. Make any necessary repairs promptly.
- Clean the motorcycle thoroughly to reveal items in need of repair.
- Make sure all legally required equipment is properly installed and in good condition, including the license plate.
- Fasteners must meet original specifications for quality, finish and type to ensure safety. Use only genuine VICTORY replacement parts, and ensure that all fasteners are tightened to the proper torque.

## Electromagnetic Interference

This vehicle complies with European directive 97/24/EC Chapter 8 requirements, which is equivalent to Canadian ICES-002.

# Safety

## Gross Vehicle Weight Rating (GVWR)

**WARNING!** Exceeding the gross vehicle weight rating of your motorcycle can reduce stability and handling and could cause loss of control. NEVER exceed the GVWR of your motorcycle.

The *maximum load capacity* of your motorcycle is the maximum weight you may add to your motorcycle *without exceeding the GVWR*. This capacity is determined by calculating the difference between your motorcycle's GVWR and wet weight.

Refer to the specification section of this manual or the Manufacturing Information/VIN label on the motorcycle frame for model-specific information. Refer to the "Safety and Information Labels" section in this manual for location on the motorcycle.

When determining the weight you will be adding to your motorcycle, and to ensure you do not exceed the maximum load capacity, include the following:

- operator body weight
- passenger body weight
- weight of all riders' apparel and items in or on apparel
- weight of any accessories *and their contents*
- weight of any additional cargo on the motorcycle



## Identification

### Ignition Key Number

The ignition key number is stamped on the small metal tag attached to the key ring. *Remove* the tag and record the number on page 99. Store the tag in a safe place.

Additional keys can be copied from one of the original keys. A VICTORY key blank is required. If you lose both original keys, you will need the following:

- Key number (recorded on page 99)
- A new key blank from a VICTORY dealer
- Proof of ownership
- A locksmith or VICTORY dealer with the equipment necessary to cut a new key

### Engine Identification Number

The engine number is stamped into the right crankcase behind the rear cylinder. Record the number in the space provided on page 99.

Engine  
Number

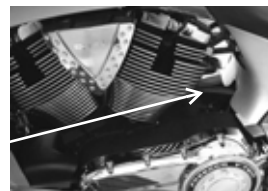

# Identification

## Left Side View

1. Spark Plugs
2. Front Brake Caliper
3. Oil Cooler
4. Battery
5. Gear Shift Pedal
6. Operator Footrest
7. Sidestand
8. Oil Drain Plug
9. Oil Filter
10. Passenger Footpeg
11. Rear Brake Caliper
12. Evaporative Emissions Canister
13. Diagnostic Connector (under cover)

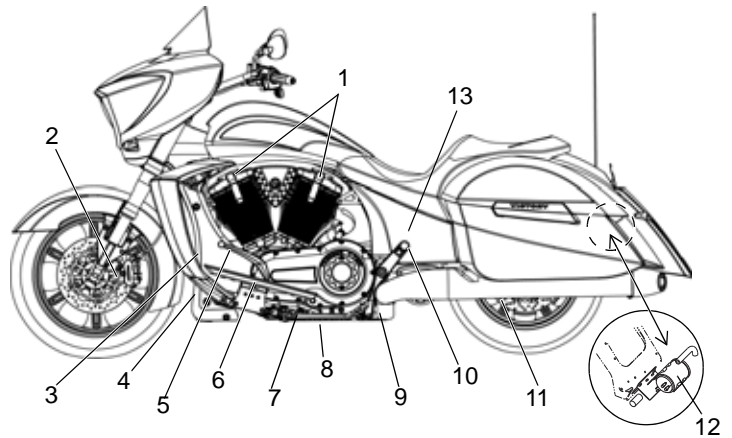

## Right Side View

1. Exhaust Mufflers
2. Drive Belt Guard
3. Drive Sprocket (under cover)
4. Engine Oil Fill Cap / Dipstick
5. Rear Brake Fluid Reservoir
6. Rear Brake Pedal
7. Air Filter
8. Headlamp
9. Mirror
10. Fuel Tank
11. Access Cover
12. Fuse Box (under cover)
13. Accessory Fuse (under cover)
14. Rear Shock Air Fitting (under cover)
15. Radio Antenna (if equipped)
16. License Plate Bracket

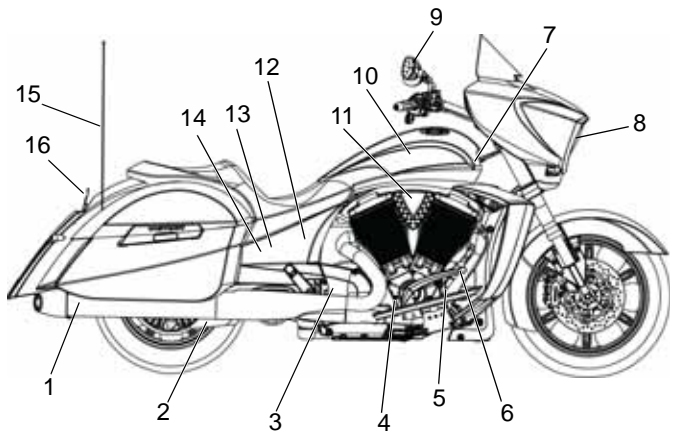

# Identification

## Top View

1. Windshield
2. Clutch Lever
3. Fuel Filler Cap
4. Operator Seat
5. Passenger Seat
6. Saddlebag Latch
7. Turn Signals
8. Tail Lamps
9. Front Brake Lever
10. Front Brake Fluid Reservoir
11. Radio Fuse (inside fairing)

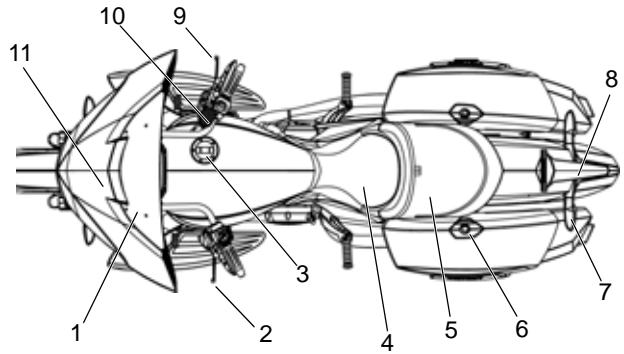

## Console (CROSS COUNTRY)

1. Speakers
2. Mode Switch
3. Fuel Gauge
4. Speedometer
5. Indicator Lamp Display
6. Multi-Function Display
7. Tachometer
8. Volt Meter
9. Left Handlebar Switches
10. Audio Control Switches
11. +12-Volt Accessory Outlet
12. Radio Display
13. Heated Grip Switch (if equipped)
14. Cruise Control Switches (if equipped)
15. Right Handlebar Switches

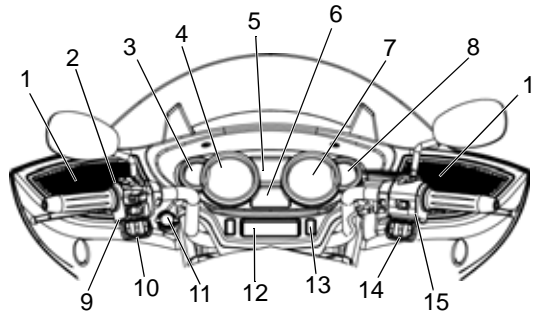

## Console (CROSS ROADS)

1. Clutch Lever
2. Mirror
3. Speedometer
4. Indicator Light Panel
5. Tachometer (if equipped)
6. Front Brake Fluid Reservoir
7. Front Brake Lever
8. Throttle Control Grip
9. Switches
10. Throttle Cables
11. Fuel Cap
12. Cruise Control Switches (if equipped)

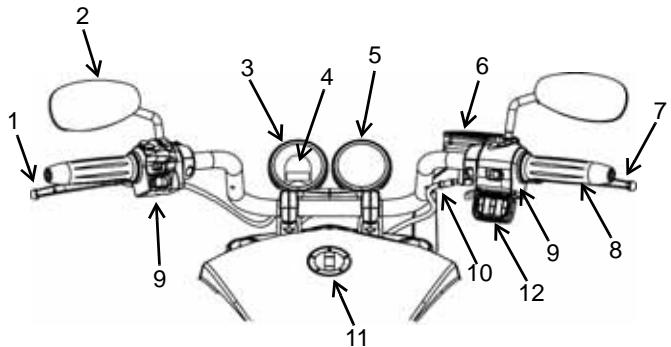

## Ignition Switch

The ignition key operates the ignition switch and parking lights. The ignition switch provides electrical power to the ignition, the lighting system and all electrical switches and buttons. Before starting the engine, read the instructions for starting the engine. See page 46.

### OFF

In the OFF position, all electrical circuits are inactive and the ignition key can be removed. Turn the ignition switch to the OFF position and remove the ignition key when leaving the motorcycle unattended.

### ON

In the ON position, all electrical circuits are energized and the ignition key cannot be removed. The headlamp, taillight, and instrument lights illuminate. The engine stop/run switch must be in the RUN position to start the engine or activate the turn signals and other electrical features.

### PARK

In the PARK position, the taillight, indicator lights and license plate light illuminate. The radio can be operated and the instrumentation is active. The emergency flashers can be activated, and the ignition key can be removed. You must push the ignition key into the switch while selecting the PARK position.



# Instruments, Features and Controls

## Instrument Cluster (CROSS ROADS)

### Speedometer

The speedometer displays vehicle speed in either miles per hour (MPH) or kilometers per hour (km/h).

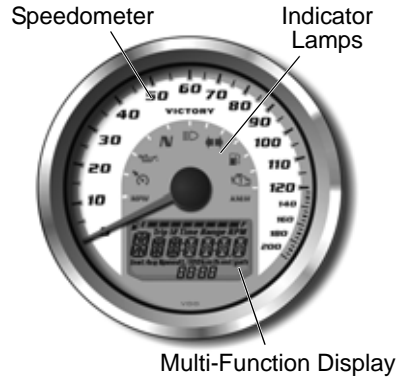

### Indicator Lamps

Lamp	Indicates	Condition
	Neutral	This lamp illuminates when the transmission is in neutral and the ignition key is in the ON position.
	High Beam	This lamp illuminates when the headlamp switch is set to high beam.
	Turn Signal	The turn signal indicator flashes when the left, right, or both turn signals (hazard) are active. <i>If a bulb fails, or if there is a short circuit in the signal system, the lamp flashes at more than twice the normal rate.</i>
	Low Oil Pressure	This lamp illuminates when the ignition switch is in the ON position and the engine is off, indicating that the indicator circuit is functioning properly. This lamp also illuminates if engine oil pressure drops below safe operating pressure. If this lamp illuminates while the engine is running, turn the engine off as soon as safely possible and check the oil level. <i>If the oil level is correct and the lamp remains on after the engine is restarted, turn the engine off immediately.</i>
	Low Fuel	This lamp illuminates when approximately one gallon (3.8 liters) of fuel remains in the fuel tank.
	Cruise Control Engaged	Before using the cruise control (if equipped), read the safety and operation procedures beginning on page 49.
	Check Engine	This lamp illuminates momentarily when the ignition switch is in the ON position and the engine is off. This indicates proper function. <i>If this lamp illuminates while the engine is running, contact an authorized VICTORY dealer promptly for diagnosis.</i> The light will remain on if the tilt sensor shuts down the engine. See page 32. If abnormal sensor or engine operation is detected the light will remain on as long as the fault condition exists. Retrieve the error codes for diagnosis. See page 26.



# Instruments, Features and Controls

## Instrument Cluster (CROSS ROADS)

### Multi-Function Display

Use the mode button to toggle through the modes of the multi-function display. See page 30. Press and hold the mode button to reset the trip odometers, average fuel economy, average speed and trip hour meter.



Modes Available	
Standard Modes	Optional Modes
Odometer	Trip Odometer 2
Trip Odometer 1	Average Fuel Economy
Clock	Instantaneous Fuel Economy
Gear Indicator	Trip Time
Fuel Level Gauge	Average Speed
Engine Speed	DC Voltage
	Ambient Air Temperature

### Odometer

The odometer displays total distance traveled.

### Trip Odometers

The ignition switch must be in the ON or PARK position to access the trip odometers. The trip odometers (Trip 1 and Trip 2) display total distance traveled since being reset. To reset a trip odometer, toggle to the trip odometer, then press and hold the mode button until the trip odometer resets to zero.

### Fuel Level

The fuel level displays bar graphics between empty (E) and full (F) to indicate the fuel level.

Fuel Level FULL



### Engine Speed

Engine speed displays in revolutions per minute (RPM).

### DC Voltage (Optional)

The volt meter displays battery voltage. If the engine is not running, approximate *battery* voltage displays. If the engine is running, approximate *charging* voltage displays.

### Gear Position

Gear position displays only when the vehicle is moving and the clutch is engaged. If the vehicle stops moving, or if the clutch is disengaged, "--" will show in the display.

### Temperature (Optional)

The key must be in the ON or PARK position to display ambient air temperature.

# Instruments, Features and Controls

## Instrument Cluster (CROSS ROADS)

### Multi-Function Display

#### Display Units (Standard/Metric)

The display can be changed to display either standard or metric units of measurement.

	Standard Display	Metric Display	
Distance	Miles	Kilometers	
Fuel	U.S. Gallons	l = Imperial Gallons	Liter = Liters
Temperature	Fahrenheit	Celsius	
Time	12-Hour Clock	24-Hour Clock	

1. Turn the key to the OFF position.
2. Press and *hold* the mode button while turning the key to the ON or PARK position.
3. When the display flashes the distance setting, tap the mode button to advance to the desired setting.
4. Press and *hold* the mode button to save the setting and advance to the next display option.
5. Repeat the procedure to change remaining display settings.

#### Clock

**Tip:** The clock must be reset any time the battery has been disconnected or discharged.

1. Turn the key to ON or PARK. Use the mode button to toggle to the odometer display.
2. Press and *hold* the mode button until the hour segment flashes. Release the button.
3. With the segment flashing, tap the mode button to advance to the desired setting.
4. Press and *hold* the mode button until the next segment flashes. Release the button.
5. Repeat steps 3-4 twice to set the 10-minute and 1-minute segments. After completing the 1-minute segment, step 4 will save the new settings and exit the clock mode.
6. Turn the key to the OFF position.

#### Trip Hours Meter

The trip hours meter displays total hours of operation since being reset. To reset the trip hours meter, toggle to the hours meter display, then press and hold the mode button until the meter resets to zero.

#### Diagnostic Functionality

Certain conditions will cause an error message to display in the screen. If this occurs, please see your VICTORY dealer.

Message	Location	Indicates
LO	DC Voltage Screen	Voltage remains below 11.0 volts for more than 10 seconds
OV	DC Voltage Screen	Voltage remains above 15.0 volts for more than 10 seconds
ERROR	All	Checksum error (gauge malfunction)

# Instruments, Features and Controls

## Instrument Cluster (CROSS ROADS)

### Multi-Function Display

#### Engine Error Codes

The error screen displays only when the CHECK ENGINE light is on or when it goes on and off during one ignition cycle. Error codes are not stored. When the key is turned OFF, the code and message is lost, but will reappear if the fault reoccurs after restarting the engine.

If the CHECK ENGINE indicator lamp illuminates, retrieve the error codes from the display.

1. If the error codes are not displayed, use the mode button to toggle until “Ck ENG” displays on the main line of the display.
2. Press and hold the mode button to enter the diagnostics code menu.
3. Record the three numbers displayed in the gear position, clock and odometer displays.
4. See an authorized VICTORY dealer for code details and diagnosis.

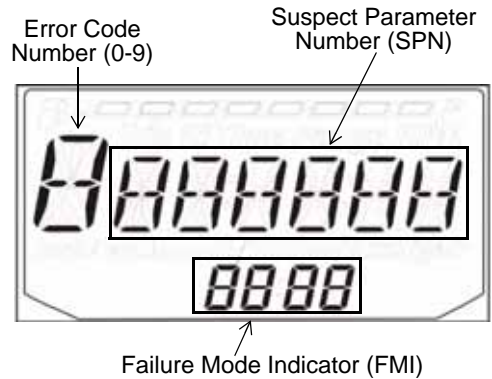

# Instruments, Features and Controls

## Instrument Cluster (CROSS COUNTRY)

The instrument cluster includes the speedometer, tachometer, fuel gauge, volt meter, indicator lamps and multi-function display.

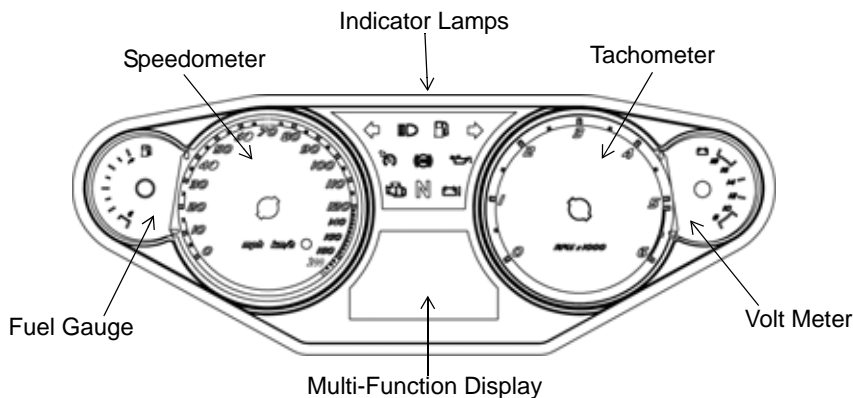

### Speedometer

The speedometer displays vehicle speed in either miles per hour or kilometers per hour.

### Tachometer

The tachometer displays engine speed in revolutions per minute (RPM). A red line on the face of the gauge indicates the maximum safe engine speed.

**WARNING!** Excessive engine speed can cause engine damage or failure, which could result in serious injury or death. Do not allow engine speed to exceed the red line.

### Fuel Gauge

The fuel gauge displays fuel level. The key must be in the ON or PARK position. For the most accurate reading, sit on the motorcycle and bring it to the upright position.

### Volt Meter





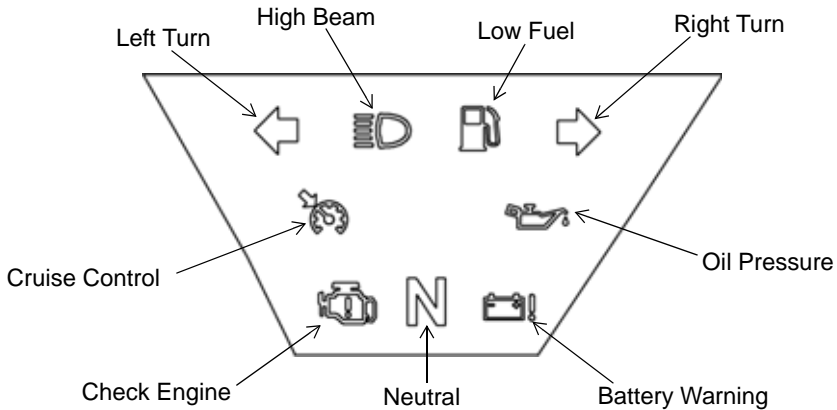

When the key is in the ON position, the volt meter displays battery voltage. If the engine is not running, approximate battery voltage displays. If the engine is running, approximate charging voltage displays.

# Instruments, Features and Controls

## Instrument Cluster (CROSS COUNTRY)

### Indicator Lamps



Lamp	Indicates	Condition
N	Neutral	This lamp illuminates when the transmission is in neutral and the ignition key is in the ON or PARK position.
	High Beam	This lamp illuminates when the headlamp switch is set to high beam.
	Check Engine	This lamp illuminates momentarily when the ignition switch is in the ON position and the engine is off. This indicates proper function. <i>If this lamp illuminates while the engine is running, contact an authorized VICTORY dealer promptly for diagnosis.</i> The light will remain on if the tilt sensor shuts down the engine. See page 32. If abnormal sensor or engine operation is detected the light will remain on as long as the fault condition exists. Retrieve the error codes for diagnosis. See page 26. This lamp is also known as a malfunction indicator lamp (MIL).
	Turn Signal	One arrow flashes when the corresponding turn signal is activated. Both arrows flash when the hazard signal is activated. <i>If a bulb fails, or if there is a short circuit in the signal system, the lamp flashes at more than twice the normal rate.</i>
	Low Oil Pressure	This lamp illuminates when the ignition switch is in the ON position and the engine is off, indicating that the indicator circuit is functioning properly. This lamp also illuminates if engine oil pressure drops below safe operating pressure. If this lamp illuminates while the engine is running, turn the engine off as soon as safely possible and check the oil level. <i>If the oil level is correct and the lamp remains on after the engine is restarted, turn the engine off immediately.</i>
	Low Fuel	This lamp illuminates when approximately one gallon (3.8 liters) of fuel remains in the fuel tank.
	Low Battery Warning	This lamp illuminates when battery voltage is low. Make sure the charging system is operating properly. See page 84.
	Cruise Control Engaged	Before using the cruise control, read the safety and operation procedures beginning on page 49.

# Instruments, Features and Controls

## Instrument Cluster (CROSS COUNTRY)

### Multi-Function Display

Use the mode button to toggle through the modes of the multi-function display. See page 30.

#### Permanently Displayed Modes

- Clock
- Gear Position
- Ambient Temperature

#### Trip Computer Modes

- Odometer
- Trip Odometers (Trip 1, Trip 2)
- Average Fuel Economy
- Average Speed
- Fuel Range
- Instantaneous Fuel Economy
- Trip Hours Meter

**Tip:** Press and hold the mode button to reset the trip odometer, average fuel economy, average speed or trip hours meter.

#### Engine Error Codes

The error screen displays only when the CHECK ENGINE light is on or when it goes on and off during one ignition cycle. Error codes are not stored. When the key is turned OFF, the code and message is lost, but will reappear if the fault reoccurs after restarting the engine.

If the CHECK ENGINE indicator lamp illuminates, retrieve the error codes from the display.

1. If the error codes are not displayed, use the mode button to toggle until "Err" displays in the clock area.
2. Record the three code numbers displayed in the gear position, temperature and odometer displays.
3. See an authorized VICTORY dealer for code details and diagnosis.

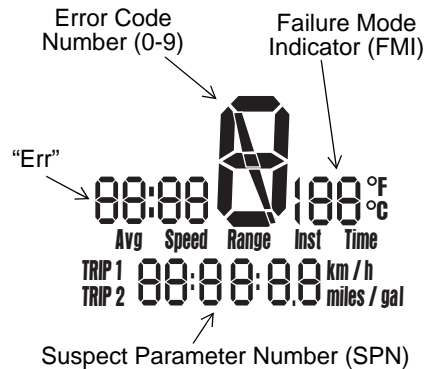
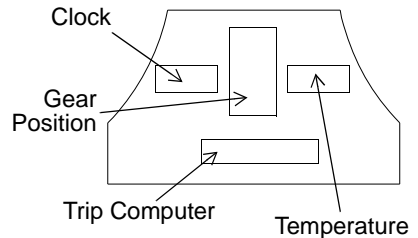

# Instruments, Features and Controls

## Instrument Cluster (CROSS COUNTRY)

### Multi-Function Display

#### Display Units (Standard/Metric)

The display can be changed to display either standard or metric units of measurement.

**Tip:** To exit the set-up mode at any time, wait 10 seconds. The display automatically exits and returns to the odometer display.

	Standard Display	Metric Display	
<b>Distance</b>	Miles	Kilometers	
<b>Fuel</b>	U.S. Gallons	l = Imperial Gallons	Liter = Liters
<b>Temperature</b>	Fahrenheit	Celsius	
<b>Time</b>	12-Hour Clock	24-Hour Clock	

#### Display Units (Standard/Metric)

1. Turn the key to the OFF position.
2. Press and *hold* the mode button while turning the key to the ON or PARK position.
3. When the display flashes the distance setting, tap the mode button to advance to the desired setting.
4. Press and *hold* the mode button to save the setting and advance to the next display option.
5. Repeat the procedure to change remaining display settings.

#### Clock

**Tip:** The clock must be reset any time the battery has been disconnected or discharged.

1. Turn the key to ON or PARK. Use the mode button to toggle to the odometer display.

**Tip:** If LOW FUEL is flashing, the display will not enter the CLOCK SET mode.

2. Press and *hold* the mode button until the hour segment flashes. Release the button.
3. With the segment flashing, tap the mode button to advance to the desired setting.
4. Press and *hold* the mode button until the next segment flashes. Release the button.
5. Repeat steps 3-4 twice to set the 10-minute and 1-minute segments. After completing the 1-minute segment, step 4 will save the new settings and exit the clock mode.
6. Turn the key to the OFF position.

# Instruments, Features and Controls

## Instrument Cluster (CROSS COUNTRY)

### Multi-Function Display

#### Odometer/Trip Odometer

The odometer displays the total distance traveled by the vehicle. The trip odometer displays distance traveled since the trip odometer was reset. To view the trip odometer, turn the key to the ON position. Use the mode button to toggle to the trip odometer.

To reset the trip odometer, toggle to the trip odometer, then press and hold the mode button until the trip odometer resets.

#### Gear Position

Gear position displays only when the vehicle is moving and the clutch is engaged. If the vehicle stops moving, or if the clutch is disengaged, "--" will show in the display.

#### Temperature

The key must be in the ON or PARK position to display ambient air temperature.

## Console Switches (CROSS COUNTRY)

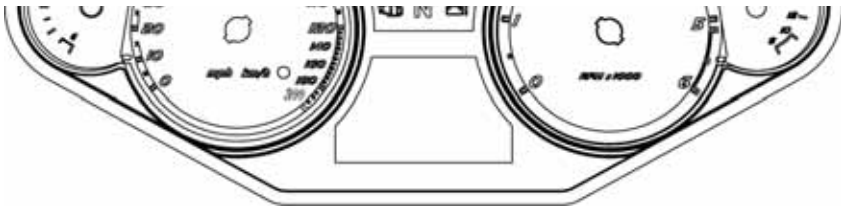

Optional Accessory Switch

Hand Grip Heater Switch

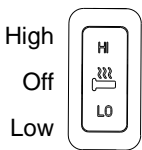

### Hand Grip Heater Switch





Press the top (high heat) or bottom (low heat) of the rocker switch to turn the hand grip heaters on. Move the switch to the center position to turn the heaters off.

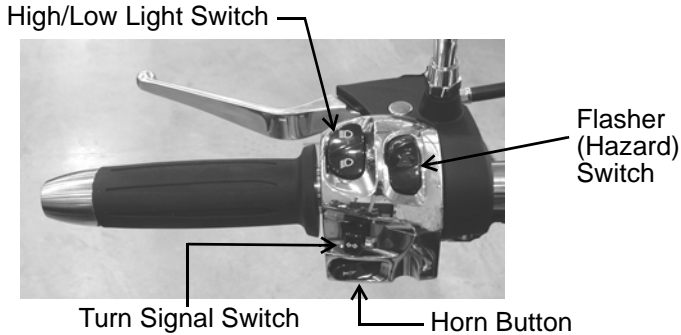

# Instruments, Features and Controls

## Left Handlebar Switches



Lamp	Switch	Description
	Emergency Flasher Switch (Hazard Switch)	The emergency flasher switch activates and cancels the emergency flashers. When the emergency flashers are active, all of the turn signals flash. Press the top of the switch to activate the emergency flashers. Press the bottom of the switch to cancel the flashers.
	High Beam/Low Beam Light Switch	The headlight high/low beam switch toggles the headlight between high beam and low beam. To activate the high beam, press the upper portion of the switch; to activate the low beam, press the lower portion of the switch.
	Horn Button	To sound the horn, press the horn button.
	Turn Signal Switch	Move the switch to the left to activate the left turn signals. Move the switch to the right to activate the right turn signals. A signal will deactivate automatically when speed or distance reach predetermined levels. To cancel a signal manually, move the switch to the center position and push it inward.  <i>Momentary Feature:</i> Move the turn signal switch left or right and hold it in that position for at least one second. The momentary feature will activate and the signal will then cancel when the switch is released.

# Instruments, Features and Controls

## Left Handlebar Switches

### Audio Switches (if equipped)

Refer to the Audio System section of this manual (beginning on page 100) for audio systems operation.

### Mode Button

The mode button is located on the front side of the left handlebar switch. Use the mode button to toggle through the modes of the multi-function display. See page 26. Use the mode button to set the display units to either standard or metric units of measurement (CROSS COUNTRY). See page 27.

**Tip:** If “Err” displays while toggling through the features, a system error has been logged. See page 26.

### Starter Interlock Switch

The starter interlock switch is located on the left handlebar. This switch prevents the electric starter from operating when the transmission is in gear and the clutch is engaged (lever released). Read the engine starting procedures beginning on page 46 before starting the engine.

**WARNING!** Never start the engine with the transmission in gear and the clutch disengaged unless you are properly seated with the front brake applied.



Audio Switches



Mode Button



Interlock Switch

Clutch Lever

# Instruments, Features and Controls

## Right Handlebar Switches

### Engine Stop/Run Switch

The engine stop/run switch is located on the right handlebar. This switch completes or interrupts the ignition, starter and fuel pump circuits. Use the engine stop/run switch to turn the engine off quickly. Turn the key off after the engine stops.

- Press the bottom of the switch (RUN) to complete the circuits and allow the engine to start and run.
- Press the top of the switch (STOP) to interrupt the circuits and stop the engine. The engine should not start or run when the switch is in the STOP position.

### Cruise Control Switches (if equipped)

Refer to the Cruise Control section of this manual (beginning on page 49) for cruise control operation.

### Engine Starter Switch

The starter switch is located on the right handlebar. Use the starter switch to start the engine and operate in reverse (if equipped). The switch will operate only when the engine stop/run switch is in the RUN position and the transmission is in neutral (or the clutch is disengaged). The reverse lever (if equipped) must also be disengaged.

**Tip:** If the reverse system fuse has blown, the starter switch will not function even if the reverse lever is disengaged. Replace the fuse. See page 80.

Read the engine starting procedures before starting the engine. See page 46.

- Press the right side of the starter switch to engage the starter motor.
- See page 52 for reverse operation.



Cruise Control Switches



Starter Switch

# Instruments, Features and Controls

## Clutch Lever

The clutch lever is located on the left handlebar. Disengage the clutch before shifting gears. For smooth clutch operation, pull the lever quickly and release it gradually.

- To disengage the clutch, pull the lever toward the handlebar.
- To engage the clutch, gradually release the lever.



Clutch Lever

## Throttle Control Grip

The throttle control grip is located on the right handlebar. Use the throttle control grip to control engine speed. While seated in the proper riding position:

- Rotate the top of the grip rearward to increase engine speed and power.
- Rotate the top of the grip forward to decrease engine speed and power.

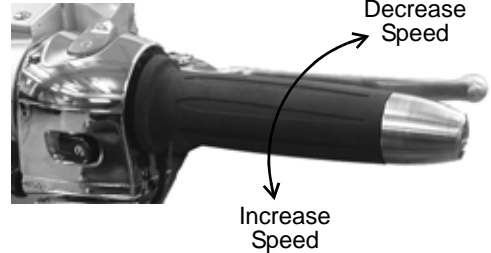

## Tilt Sensor

A tilt sensor stops the engine if the motorcycle tips beyond 45 degrees to one side. The check engine light or message will also activate. To restart the engine, cycle the ignition switch to the OFF position, wait 20 seconds, then restart the engine.

# Instruments, Features and Controls

## Brakes

The front brake lever activates the front brake calipers. The rear brake pedal activates the rear brake caliper. For maximum brake effectiveness, apply the front brake lever and the rear brake pedal together.

### Front Brake Lever

The front brake lever is located on the right handlebar. This lever controls only the front brakes. The front brakes should be applied simultaneously with the rear brakes.

To apply the front brake, pull the lever toward the handlebar.

See page 49 for braking procedures.

Front brake lever reach (distance to the hand grip) is adjustable.

1. *Pull and hold* the lever away from the hand grip.
2. To increase reach distance, rotate the adjuster to align a lower number with the arrow on the lever.
3. To decrease reach distance, rotate the adjuster to align a higher number with the arrow on the lever.

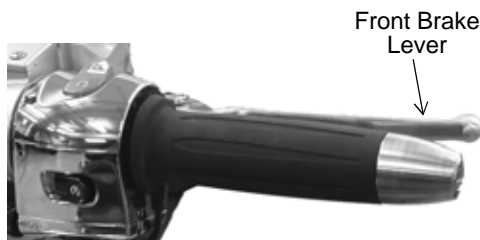

### Rear Brake Pedal

The rear brake pedal is located on the right side of the motorcycle. Press downward on the rear brake pedal to apply the rear brake.

The rear brake pedal activates the rear brake caliper fully.

See page 34 for pedal adjustment options.

See page 49 for braking procedures.



### Gear Shift Pedal

The gear shift pedal is located on the left side of the motorcycle.

- Press downward on the gear shift pedal to shift to a lower gear.
- Lift up on the gear shift pedal to shift to a higher gear.

See page 34 for pedal adjustment options. See pages 47-48 for gear shifting procedures.



Gear Shift Pedal

# Instruments, Features and Controls

## Pedal Adjustment

The brake pedal and gear shift pedal controls can be adjusted to a front, rear or center position. The center position is the factory setting.

1. Remove the screw from the footwell support.  
**Tool:** 6 mm Allen wrench
2. Slide the control forward or rearward in its track until the threaded hole of the control aligns with the desired hole in the footrest support.
3. Reinstall the screw.  
**Torque:** 96 in-lbs (11 Nm)
4. After adjusting the shift pedal, always readjust the shift linkage rod. Loosen both jam nuts on the linkage and turn the shaft until the footpeg is about 90 mm from the floorboard (or to desired height). Tighten both jam nuts.  
**Torque:** 96 in-lbs (11 Nm)

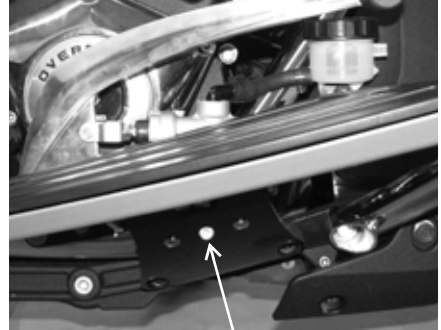

Center Adjustment Position

## Sidestand

The sidestand is located on the left side of the motorcycle.

**WARNING!** An improperly retracted sidestand could contact the ground and cause a loss of control resulting in serious injury or death. Always retract the sidestand fully before operating the motorcycle.

To park the motorcycle, swing the end of the sidestand downward and away from the motorcycle until it is fully extended. Lean the motorcycle to the left until the sidestand firmly supports the motorcycle.

To retract the sidestand, straddle the motorcycle and bring it to the fully upright position. Swing the end of the sidestand upward and toward the motorcycle until it is fully retracted.



# Instruments, Features and Controls

## Saddlebag Lock

Use the ignition key to lock and unlock the saddlebag doors. The doors should be locked before riding.

To lock a door, place the key in the lock and turn it counter-clockwise. To unlock a door, turn the key clockwise.

After unlocking a door, press the door lock to release the latch and open the door.

Refer to the Gross Vehicle Weight Rating information beginning on page 14 for loading information.

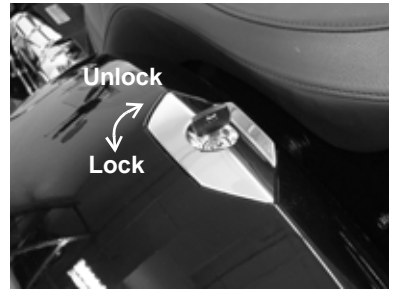

## Fuel Cap

Use the ignition key to lock and unlock the fuel cap. Always lock the fuel cap before riding. An open fuel cap could contact the handlebar.

To open the fuel cap, lift the lock cover. Place the key in the lock and turn it clockwise.

To secure the fuel cap, push the cap down to engage the latch. Turn the key counter-clockwise to lock the cap.



## Tool Kit

The tool kit can be used to perform most basic maintenance items. Tools provided in the tool kit include:

1. 4 mm Ball Drive Allen Wrench
2. 5 mm Ball Drive Allen Wrench
3. 6 mm Ball Drive Allen Wrench
4. 4 mm / 6 mm Open End Wrench
5. 8 mm / 10 mm Open End Wrench
6. Combination Phillips / Slot Screw Driver
7. Rear Shock Absorber / Tire Pressure Gauge
8. Fuse Puller

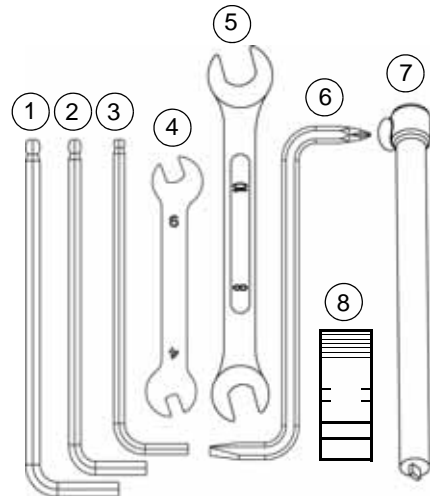

# Pre-Ride Inspections

To keep your motorcycle in safe operating condition, always perform the recommended pre-ride inspections before each ride. This is especially important before making a long trip and when removing the motorcycle from storage.

**WARNING!** Failure to perform the recommended pre-ride inspections could result in component failure while riding, which could result in serious injury or death. Always perform the pre-ride inspections before each ride. When inspection reveals the need for adjustment, replacement or repair, perform the service promptly.

You must be familiar with all instruments and controls to perform the pre-ride inspections.

**Tip:** During the pre-ride inspections you may use products that are potentially hazardous, such as oil or brake fluid. When using any of these products, always follow the instructions and warnings on the product packaging.

When inspections reveal the need for adjustment, replacement or repair:

- refer to the maintenance section of this manual
- refer to the service manual
- or see your authorized VICTORY dealer



# Pre-Ride Inspections

Turn the ignition key to the ON position and move the stop/run switch to RUN before performing the following electrical inspections. Return the ignition key to the OFF position after completing these inspections. If inspection of any electrical item reveals component failure, repair or replace the component before operating the motorcycle.

Item	Inspection Procedure
<b>Electrical</b>	
Headlamp	Switch to high beam. Verify that the high beam indicator comes on and that lamp brightness increases.
Taillight/Brakelight	Verify that the taillight and license plate light illuminate. Verify that the taillight lamps increase in brightness when the front brake lever is applied and also when the rear brake pedal is applied.
Turn Signals	Move the turn signal switch to the left. Verify that front and rear left turn signals flash, as well as the corresponding light on the indicator panel. Push the switch inward to cancel the signal. Verify that the signals and the indicator light stop flashing. Repeat the procedure for the right turn signals.
Emergency Flashers	Press the top of the hazard switch to turn the flashers on. Verify that all four turn signals flash, as well as the lamps on the indicator panel. Turn the flashers off. Verify that all signals and indicator lamps stop flashing.
Horn	Press the horn button. Verify that the horn sounds loudly.
Neutral Indicator	Place the transmission in neutral. Verify that the neutral indicator lamp illuminates and that the letter "N" displays in the gear position display.
Low Oil Pressure Indicator	Verify that the low oil pressure lamp illuminates. Start the engine and verify that the low oil pressure lamp goes off.
Engine Stop/Run Switch	Start the engine. Move the stop/run switch to the STOP position. Verify that the engine stops. Attempt to restart the engine to verify that the engine WILL NOT start.
<b>General</b>	
Engine Oil Level	Check the oil level on the dipstick.
Fuel Level	View the fuel gauge or information bar.
Tires	Inspect condition, pressure and tread depth.
Brake Operation	Inspect pedal and lever movement.
Brake Fluid Levels	Check front and rear brake fluid levels.
Brake Components	Inspect hoses, connections, brake pads.
Throttle	Inspect hand grip and throttle freeplay.
Clutch (Mechanical)	Check lever operation and freeplay.
Front Suspension	Check for leaks, debris and damage.
Steering	Check for smooth operation.
Rear Suspension	Check shock movement and air pressure, verify ground clearance.
Drive Belt	Check for wear, damage, proper deflection.
Sidestand	Verify smooth operation, inspect pivot bolt, spring and pad.
Fasteners	Inspect for loose, damaged or missing fasteners.
Mirrors	Adjust for proper rear view.

# Pre-Ride Inspections

## Engine Oil Level

The oil fill cap/dipstick is located on the right side of the vehicle. Always use the recommended oil. See page 99.

**Tip:** The engine must be at normal operating temperature when checking the oil level.

1. Place the transmission in neutral.
2. Start the engine and allow it to idle for several minutes.
3. Stop the engine and wait 3-5 minutes before checking the oil level.
4. On level ground, straddle the motorcycle and bring it to the fully upright position.
5. Remove the oil fill cap/dipstick and wipe it clean. Reinstall the dipstick and turn the cap clockwise until it seats.
6. Remove the dipstick and view the oil level.
7. Add or remove oil as needed to bring the level into the safe operating range (between the FULL and ADD marks) on the dipstick.

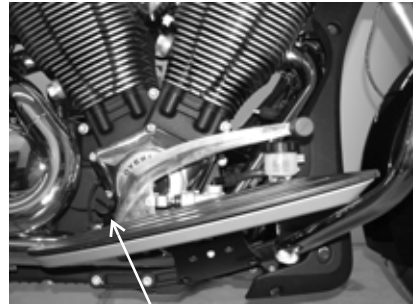

Oil Fill Cap/Dipstick

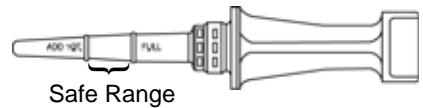

Safe Range

**WARNING!** Operating the engine with too much or too little oil can cause serious engine damage or engine seizure, which could result in loss of control and serious injury or death. Do not operate the motorcycle with the oil level above the FULL mark or below the ADD mark.

## Fuel Level

1. On level ground, straddle the motorcycle and bring it to the fully upright position.
2. Turn the ignition switch to the ON or PARK position. View the fuel level in the fuel gauge (CROSS COUNTRY), or use the MODE button to toggle to the fuel display in the information bar (CROSS ROADS).
3. Refuel as needed. See page 99 for fuel specifications.

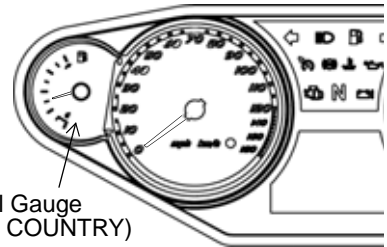

Fuel Bar  
(CROSS ROADS)

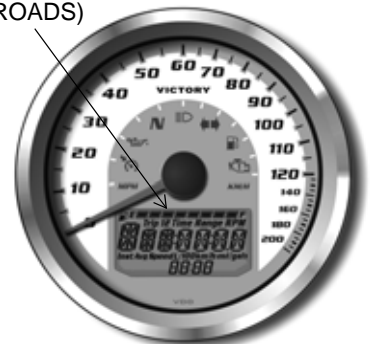

# Pre-Ride Inspections

## Tires

### Tire Pressure

Check tire pressure before riding, when the tires are cold. This will provide the most accurate reading, as riding warms the tires and increases tire air pressure.

Adjust tire pressure as needed based on the total weight of your intended load. See page 74.

### Tire Condition

Inspect the tire sidewalls, road contact surface and tread base. If inspection reveals cuts, punctures, cracks or other wear or damage, replace the tire before riding.

### Tire Tread Depth

Measure the tread depth near the center of the tread on both tires. See page 73. Replace any tire with a tread depth of less than 1/16" (1.7 mm).

## Front Brake Lever

1. Pull the front brake lever toward the handlebar and hold it. The lever should move freely and smoothly. It should not move more than 3/4 inch (19 mm) before resistance is firm. It should continue to feel firm, without loss of pressure, until the lever is released.
2. Release the lever. It should return to its rest position quickly when released.
3. If the front brake lever fails to perform as stated, service the brake lever before riding.
4. See page 33 for front brake lever reach adjustments.

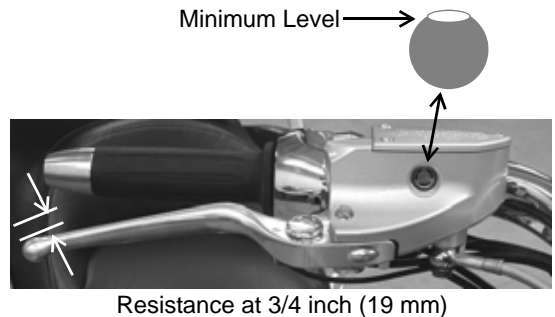

## Front Brake Fluid Level

1. Straddle the motorcycle and bring it to the fully upright position. Position the handlebars so that the fluid reservoir is level.
2. View the fluid level through the sight glass. The fluid should be clear. Replace cloudy or contaminated fluid.
3. The fluid level should be at or above the top of the sight glass. Add brake fluid if necessary. See page 72.

# Pre-Ride Inspections

## Rear Brake Pedal

1. Press downward on the rear brake pedal. It should move freely and smoothly. It should not move more than 3/8 inch (8 mm) before resistance is firm. It should continue to feel firm, without loss of pressure, until the pedal is released.
2. Release the pedal. It should return to its rest position quickly when released.
3. If the rear brake pedal fails to perform as stated or travels too far before beginning to engage the brake, service the brakes before riding.
4. See page 34 for rear brake pedal adjustments.

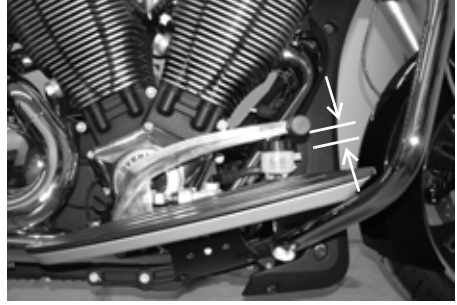

Resistance at 3/8 inch (8 mm)

## Rear Brake Fluid Level

The rear brake fluid reservoir is located near the rear brake pedal. View the reservoir from the front right side of the vehicle.

1. Position the motorcycle on level ground in the fully upright position.
2. View the brake fluid through the reservoir.
3. The fluid should be clear. Replace cloudy or contaminated fluid.
4. The fluid level should be between the minimum and maximum marks on the reservoir. Add brake fluid as needed. See page 71.

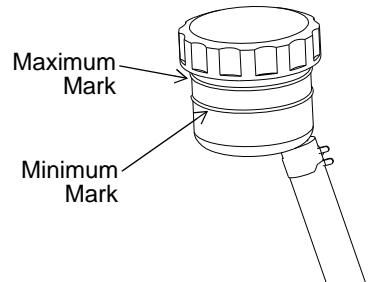
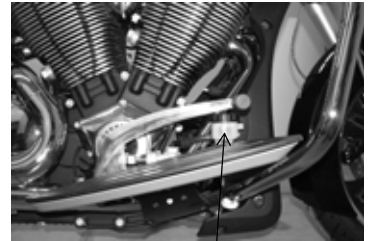

## Brake Lines

Inspect all brake hoses and connections for dampness or stains from leaking or dried fluid. Tighten any leaking connections and replace components as necessary.

**Tip:** Refer to the service manual or contact your dealer for fastener torque values.

**WARNING!** Brake fluid leaks or low brake fluid levels could cause brake system failure, which could result in serious injury or death. Do not operate the vehicle with low brake fluid levels or when leaks are evident (dampness or stains from dried fluid). See your VICTORY dealer for service.

# Pre-Ride Inspections

## Brake Pads

Inspect each front brake pad on both sides of the front disc. Inspect each rear brake pad on both sides of the rear disc. When the thinnest point of the friction material has worn to the minimum recommended thickness, see your VICTORY dealer for brake pad replacement.

Replace brake pads when friction material thickness reaches 1.0 mm.

When checking brake pad friction material thickness, check each brake caliper for dampness or stains from leaking or dried brake fluid. If inspection reveals signs of fluid leakage, do not operate the vehicle. See your VICTORY dealer for service.

See page 72 for brake disc inspection.

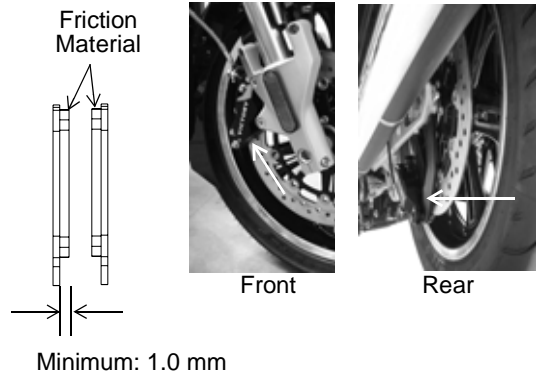

## Throttle

Rotate the throttle control grip. It should rotate smoothly from the rest position to the completely open position. It should return to the rest position quickly when released.

### Throttle Freeplay

Throttle freeplay is the amount of throttle control grip movement from the rest position to the point of cable resistance. Measure this distance.

Freeplay should be 2-4 mm. Adjust throttle freeplay as needed. See page 68.

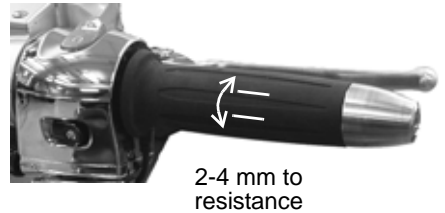

## Mechanical Clutch

1. Squeeze the clutch lever toward the handlebar and release it. It should move freely and smoothly, and it should return to the rest position quickly when released. If the lever fails to perform as stated, service the clutch lever before riding.
2. Freeplay (gap) is the amount of lever movement from the rest position to the point of cable resistance. Clutch lever freeplay should be 0.5-1.5 mm. Measure the gap between the clutch lever and the lever housing. Adjust clutch lever freeplay if necessary. See page 69.

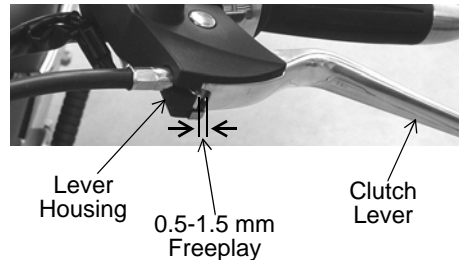

**Tip:** The starter interlock switch is dependent on the clutch lever freeplay being set correctly to ensure activation of the clutch safety switch.

# Pre-Ride Inspections

## Front Suspension

Inspect the front forks for oil leaks or damage, and verify smooth suspension operation. See page 66.

## Steering

1. On level ground, straddle the motorcycle and bring it to the fully upright position. Turn the handlebars from stop to stop. The action should be smooth, but not loose.
2. Make sure wires, hoses and control cables do not interfere with smooth steering.

## Rear Suspension

1. Check rear shock absorber movement and air pressure to ensure the correct amount of suspension travel and ground clearance.
2. For air pressure adjustment information, see page 64 or refer to the suspension air pressure label located in the left saddlebag near the air fitting.

**WARNING!** Inadequate ground clearance could result in components contacting the ground, causing loss of control and serious injury or death. Always ensure ground clearance is at specification.

## Drive Belt

1. Check drive belt tension. See page 61. The drive belt should fit tightly.

**Tip:** The drive belt system must be cool, clean and dry to accurately measure belt tension (deflection). Do not measure belt tension when the belt or drive system is wet, or when it is hot (such as immediately after riding).

2. Check the drive belt teeth for stones or other debris.
3. Inspect drive belt condition. If you discover cracks, broken teeth or frayed edges, replace the drive belt before riding. See the *VICTORY Service Manual* or an authorized VICTORY dealer.

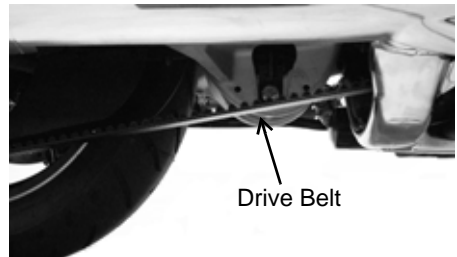

# Pre-Ride Inspections

## Sidestand

1. On level ground, straddle the motorcycle and bring it to the fully upright position.
2. Move the sidestand up to the stored position and down to the fully extended position several times. It should move smoothly and quietly. Make sure the return spring holds the sidestand tightly in place when the sidestand is in the stored position. Adjust or replace a loose spring.
3. Inspect the sidestand pivot bolt for looseness or wear. Tighten or replace a loose or worn bolt.
4. Inspect the sidestand rubber pad. Make sure the pad is firmly attached to the sidestand. Check the wear indicator on the leading edge of the pad. Replace the pad when it's worn beyond the wear limit line.

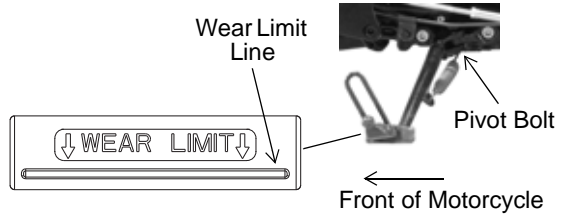

## Fasteners

1. Inspect the entire motorcycle chassis and engine for loose, damaged or missing fasteners. Tighten loose fasteners to the proper torque.
- Tip:** Refer to the specifications section of this manual or the service manual for fastener torque values, or see your VICTORY dealer.
2. Always replace stripped, damaged or broken fasteners before riding. Use genuine VICTORY fasteners of equal size and strength.

# Operation

The operation section of this manual describes how to ensure maximum performance and longevity through the proper care and operation of your motorcycle.

**Tip:** Even if you're an experienced motorcycle operator or passenger, read all of the safety information in this manual before operating the motorcycle. See page 5.

Important areas covered by the operation section include:

- Engine Break-In
- Fueling
- Starting the Engine
- Shifting Gears
- Accelerating
- Using Cruise Control (if equipped)
- Braking
- Stopping the Engine
- Parking

## Engine Break-In

The engine break-in period for your motorcycle is the first 500 miles (800 km) of operation. During this break-in period, critical engine parts require special wear-in procedures so they seat and mate properly. Read, understand and follow all break-in procedures to ensure the long-term performance and durability of your engine.

**NOTICE:** Failure to properly follow the engine break-in procedures outlined in this manual can result in serious damage to the engine. Follow all break-in procedures carefully. Avoid full throttle operation and other conditions that may place an excessive load on the engine during the break-in period.

Odometer		Break-in Procedure
Miles	Km	
0-90	0-145	Do not operate for extended periods above 1/3 throttle or at any one throttle position. Vary engine speed frequently.
91-300	146-483	Do not operate for extended periods above 1/2 throttle or at any one throttle position. Vary engine speed frequently.
301-500	484-800	Do not operate for extended periods above 3/4 throttle.
At 500	At 800	Perform the break-in maintenance outlined in the maintenance section of this manual. Break-in maintenance should be performed by an authorized VICTORY dealer. Break-in maintenance must include inspection, adjustments, fastener tightening and an engine oil and filter change. Performing break-in maintenance at the required odometer reading helps ensure peak engine performance, minimal exhaust emissions and maximum service life of the engine.



## Fueling

Always refuel on level ground with the sidestand down. Review the fuel warnings. See page 12. Use only the recommended fuel. See page 99. Hold the nozzle while filling. Do not rest the weight of the nozzle and hose on the filler neck. Do not leave the nozzle unattended.

**WARNING!** Overflows or spilled gasoline could contact a hot engine or exhaust system and cause a fire, which could result in serious injury or death. Do not allow gasoline to contact hot components.

1. Insert the fuel nozzle into the fuel tank filler neck.
2. Fill the fuel tank to a level just below the bottom of the fuel filler insert.

**WARNING!** Fuel expands in the fuel tank. Do not overfill. To prevent leaks, make sure the fuel filler cap is properly seated.

3. Always lock the fuel cap before riding. An open fuel cap could contact the handlebars.

**NOTICE:** Fuel can damage painted surfaces and plastic parts. If gasoline spills on the any part of the motorcycle, immediately rinse it off with water or wipe it dry with a clean cloth.

## Priming the Fuel System

If the motorcycle runs out of fuel, prime the fuel system before attempting to restart the engine.

1. Fill the fuel tank.
2. Turn the ignition key to the ON position.
3. Move the engine stop/run switch from the STOP position to the RUN position.
4. Allow the fuel pump to run until it stops (about 3 seconds).
5. Move the engine stop/run switch to the STOP position and wait 20 seconds.
6. Repeat steps 3-5 four to five times.
7. Turn the key to the OFF position.
8. Start the engine. See page 46.

# Operation

## Starting the Engine

The starter interlock system allows the engine to be started only when the transmission is in neutral, or when the transmission is in gear with the clutch disengaged (clutch lever pulled in).

**Tip:** If the motorcycle runs out of fuel, prime the system before attempting to restart the engine. See page 45.

1. Perform the Pre-Ride Inspections. See page 36. Properly secure any cargo.
2. Straddle the motorcycle and bring it to the fully upright position.
3. Retract the sidestand.
4. Insert the key into the ignition switch. Turn the key to the ON position.
5. Move the engine stop/run switch to the RUN position. You should hear the fuel pump run momentarily as it pressurizes the fuel system.
6. If the neutral indicator is not illuminated, shift the transmission to neutral.
7. Apply the front brakes.
8. Leaving the throttle closed, press and hold the starter switch to start the engine. Release the switch promptly when the engine starts. If the engine does not start within 10 seconds, release the starter switch. Wait five seconds, then try again.

**Tip:** Hold the starter switch for as short a time as possible to minimize battery drain. Do not hold the starter switch for more than 10 seconds at one time.

9. If either the check engine indicator or the low oil pressure indicator does not go out after the engine starts, stop the engine *immediately*. Refer to either the check engine indicator information on page 25 or the low oil pressure indicator information on page 25.
10. Leave the throttle closed and allow the engine to idle. Idle speed will gradually slow to normal as the engine warms to operating temperature.

**Tip:** Do not rev the engine or put the transmission in gear immediately after starting the engine. Allow the engine to idle for about 30 seconds after a warm start or at least one minute after a cold start (longer in cold weather). This will allow oil to reach all areas before the engine is put under load.

## Shifting Gears

**WARNING!** Forced shifting (with clutch engaged) could cause damage to the engine, transmission and drive train. Such damage could cause loss of control, which could result in serious injury or death. Always pull the clutch lever fully toward the handlebars to disengage the clutch before shifting gears.

This motorcycle is equipped with a six-speed transmission. The sixth gear is overdrive. Neutral is located between first and second gear.

**Tip:** The transmission is in neutral if you can move the motorcycle forward or rearward freely without disengaging the clutch. If the ignition switch is in the ON position, the neutral indicator illuminates when the transmission is in neutral.

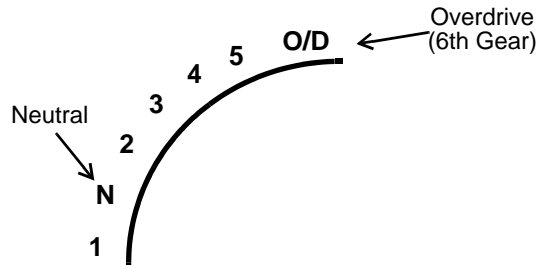

1. Start the engine. See page 46.
2. With the engine at idle speed, apply the front brakes.
3. Disengage the clutch (pull the clutch lever fully toward the handlebar).
4. Push the shift pedal downward until you feel it stop in first gear.

**Tip:** Shift to a higher gear by lifting the front of the gear shift pedal with your toe. Shift to a lower gear by pressing the pedal downward.

5. Release the brake lever.
6. Simultaneously release the clutch lever while opening the throttle (rolling the throttle control grip rearward) in one smooth motion. As the clutch begins to engage, the motorcycle will move forward.
7. To shift to a higher gear, accelerate smoothly to the recommended shift point. See page 48. With a quick motion, simultaneously close the throttle completely and disengage the clutch. Raise the shift pedal until you feel it stop at the next gear. Simultaneously release the clutch lever and open the throttle in one smooth motion.

# Operation

## Shifting Gears

**Tip:** Within the recommended speed ranges (see page 48), you can downshift to slow the motorcycle or to increase power. You may want to downshift when climbing a hill or passing. Downshifting also helps to decrease speed when combined with closing the throttle.

8. To shift to a lower gear (downshift), simultaneously pull the clutch lever toward the handlebar and close the throttle. Move the shift pedal downward until you feel it stop at the next gear. Simultaneously release the clutch lever while opening the throttle.

**WARNING!** Downshifting improperly could cause transmission damage, loss of traction and loss of control, which could result in serious injury or death.

- Reduce speed before downshifting. Always downshift within the recommended shift points.
- Use extreme caution when downshifting on wet, slippery or other low traction surfaces. Release the clutch lever very gradually in these conditions.
- Avoid downshifting in a curve. Downshift before entering the curve.

### Recommended Shift Points

Upshifting (Accelerating)			Downshifting (Decelerating)	
Gear Change	Recommended Speed		Gear Change	Recommended Speed
1 to 2	18 MPH (29 km/h)		O/D to 5	50 MPH (80 km/h)
2 to 3	30 MPH (48 km/h)		5 to 4	35 MPH (56 km/h)
3 to 4	40 MPH (64 km/h)		4 to 3	25 MPH (40 km/h)
4 to 5	50 MPH (80 km/h)		3 to 2	15 MPH (24 km/h)
5 to O/D	60 MPH (96 km/h)		2 to 1	10 MPH (16 km/h)

## Accelerating

Accelerate by opening the throttle (rolling the throttle control grip rearward). For even acceleration, open the throttle with a smooth, continuous motion. When you reach the recommended speed for upshifting, shift up one gear.

**WARNING!** Accelerating abruptly could cause your body to shift rearward suddenly, which could result in loss of control. Accelerating abruptly could also cause loss of control on low traction surfaces. Loss of control could result in serious injury or death. Always accelerate gradually, especially on wet, slippery or other low traction surfaces.

## Braking

Always allow sufficient stopping distance so that brakes can be applied gradually.

**Tip:** Applying slightly more front brake than rear brake generally provides the best braking performance.

1. To slow the motorcycle with the brakes, close the throttle and apply the front and rear brakes evenly and gradually.
2. As the motorcycle slows, disengage the clutch, or downshift each time vehicle speed reaches a downshift point.

**WARNING!** Braking improperly could result in loss of control, which could result in serious injury or death. Avoid braking abruptly. Always apply the brakes gradually, especially on wet, slippery or other low traction surfaces. Avoid braking in a curve or turn. Bring the motorcycle to the upright position before applying the brakes.

## Using Cruise Control (if equipped)

If equipped, the cruise control is located on the right handlebar. Read this section and understand how to safely operate this feature before using the cruise control.

**WARNING!** Improper operation of cruise control could cause loss of control and result in serious injury or death. Follow all cruise operation procedures carefully. Never use cruise control when roads are wet or slippery. Do not use cruise control when riding in heavy or congested traffic.

### Cruise Control Tips

- Cruise control can be set in any gear.
- Vehicle speed must be above 25 MPH (40 km/h).
- Set speed will vary slightly in hilly terrain.
- Cruise control will not resume a pre-set speed if the resulting acceleration or deceleration rate is too high or too low. For example, resuming a set speed from 40 MPH (64 km/h) while in 6th gear may cause cruise to disengage.
- Cruise control will not engage if brake lights are not operating properly.

### Set Speed

1. Press the cruise control ON button.

**Tip:** The cruise control indicator lamp will illuminate when the ON or OFF switch is pressed.

2. Wait at least 3 seconds. A red dot (power indicator) at the center of the switch will illuminate to indicate when cruise control can be engaged.
3. Accelerate to the desired speed and press the SET switch. The cruise control indicator lamp will illuminate.



Cruise Control Switches

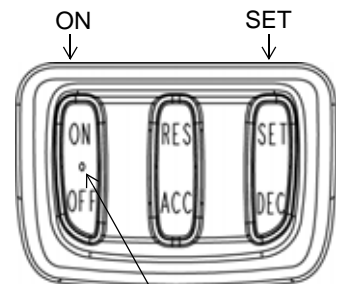

Power Indicator

# Operation

## Using Cruise Control (if equipped)

### Resume Speed

After disengaging the cruise control with the brake, throttle or clutch, wait at least 3 seconds, then press the resume button (RES) to return to the set speed.

If the resume button is pressed within 3 seconds of disengaging, the cruise control may not engage, even if the cruise control indicator illuminates. This is a safety feature that prevents cruise control from engaging if a button is stuck. To continue using cruise control, disengage it. Wait at least 3 seconds, then press the resume button.

**Tip:** Turning the cruise control master switch off will erase the set speed from memory and disengage the cruise control.

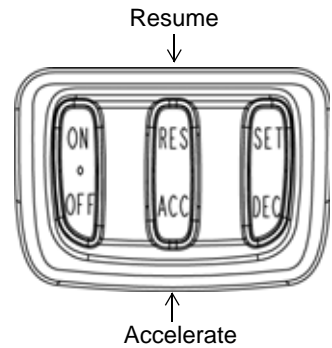

### Accelerate

Tap and release the accelerate (ACC) button to increase speed in approximately 1 MPH (1-2 km/h) increments. Press and hold the ACC button to accelerate to a new SET speed (resets when button is released).

**Tip:** If you use the throttle to accelerate and then release it, the cruise control will resume the previously set speed.

### Decelerate

Tap and release the decelerate (DEC) button to decrease speed in approximately 1 MPH (1-2 km/h) increments. Press and hold the DEC button to decelerate to a new SET speed (resets when button is released), or to the minimum cruise speed of 25 MPH (40 km/h).

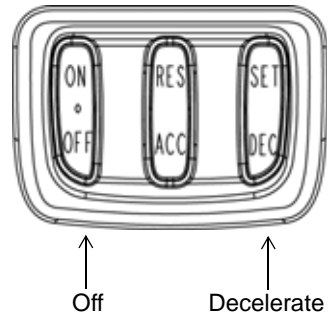

### Cancel Cruise Control

To temporarily cancel the cruise control and allow use of the resume feature:

- apply the brakes
- or close the throttle
- or disengage the clutch

To cancel the cruise control and erase the set speed from memory, press OFF.

## Stopping the Engine

Before stopping the engine, bring the motorcycle to a complete stop. Shift to neutral or disengage the clutch.

**WARNING!** Stopping the engine with the transmission in gear while the motorcycle is moving could cause loss of rear wheel traction or engine and transmission damage, which could cause loss of control and serious injury or death. Always stop the engine after the motorcycle is fully stopped and the transmission is in neutral. If the engine stops unexpectedly while the motorcycle is moving, guide the motorcycle to a safe location off the road and away from traffic.

1. When fully stopped, shift into neutral.
2. Move the engine stop/run switch to the STOP position.
3. Move the ignition switch to the OFF position. Remove the ignition key.

**Tip:** A momentary clicking sound from the IAC valve is normal when the key is first turned to the OFF position.

## Parking

Choose a firm level surface to park the motorcycle.

1. When fully stopped, shift into neutral.
2. Stop the engine.
3. Fully extend the sidestand.
4. Turn the handlebars to the left and lean the motorcycle to the left until the sidestand firmly supports the motorcycle.
5. Remove the ignition key.

## Parking on a Slope

If parking on a slope is unavoidable, position the front of the motorcycle toward the top of the slope. Place the transmission in gear and position the motorcycle so that it is stable when it rests on the sidestand.

## Parking on a Soft Surface

If parking on a soft surface is unavoidable, place a sidestand footrest under the foot of the sidestand to provide a firm surface. The sidestand footrest must be strong enough and large enough to support the motorcycle's weight without sinking into the parking surface.

Asphalt becomes soft in hot weather. A sidestand can sink into soft asphalt and the motorcycle may fall. When parking on asphalt in hot weather, use a sidestand footrest.

**CAUTION!** Hot engine and exhaust components can cause burns to skin and can ignite a fire if exposed to flammable materials. Always park the motorcycle clear of flammable materials and where people are not likely to contact hot components.

# Operation

## Reverse Operation (if equipped)

**NOTICE:** Do not attempt to engage or disengage the reverse system when the motorcycle is moving.

### Before Operating in Reverse:

- always sit on the motorcycle with legs astride and both feet on the ground.
- always check for obstacles or people behind the motorcycle.
- always retract the sidestand fully.
- always make sure the motorcycle is completely stopped.

### NEVER Operate in Reverse:

- when not properly seated.
- when in an area where obstacles or bystanders are present.
- with a passenger on board. A passenger can obstruct your view and maneuverability.
- when on loose or slippery surfaces. Loss of foot traction could cause a tip-over.
- while the motorcycle is moving forward.
- when on a grade or uneven surfaces.

### Reverse Operation Procedure

1. Always check for obstacles or people behind the motorcycle. Be aware that the front wheel may travel outward and require a larger operating area.
2. Make sure the motorcycle is stationary.
3. Dismount any passenger.
4. Straddle the motorcycle and bring it to the fully upright position. Sit in a normal riding position with legs astride and both feet on the ground.
5. Retract the sidestand.
6. Place the transmission in neutral.
7. Start the engine and allow it to idle.
8. Lift the reverse lever and verify that the reverse indicator (R) displays in the multi-function display.
9. Recheck the area behind and around the motorcycle to ensure a clear operating area.
10. While balancing the motorcycle with your legs and feet, press and hold the starter switch to begin moving in reverse. Release the switch to stop moving.
11. When completely stopped, move the reverse lever down to the disengaged position. Verify that the neutral indicator (N) displays before stopping the engine.

**Tip:** The engine will stop if you shift into forward gear before disengaging the reverse lever.



## Safety During Service Procedures

### **WARNING**

Failure to follow recommended precautions and procedures could result in severe injury or death. Always heed all safety precautions and follow all operation, inspection and maintenance procedures outlined in this manual.

- Improperly installed or adjusted components can make the motorcycle unstable or hard to handle. Improperly installed electrical components can cause engine or electrical system failure. In either event, damage or serious injury could result. If you do not have the time, tools and expertise necessary to complete a procedure properly, please see your dealer for service.
- Review the safety-related maintenance information on page 13.
- Before beginning any maintenance procedure, read the instructions for the entire procedure.
- Always position the motorcycle on a firm level surface before performing service. Make sure the motorcycle will not tip or fall while elevated or while on the sidestand.
- Hot engine and exhaust components can cause burns to skin and can ignite a fire if exposed to flammable materials. Always park the motorcycle clear of flammable materials and where people are not likely to contact hot components.
- Wear eye and face protection when using pressurized air.
- Never start the engine or let it run in an enclosed area. Engine exhaust fumes are poisonous and can cause loss of consciousness or death in a short time.
- During some procedures you may use potentially hazardous products such as oil or brake fluid. Always follow the instructions and warnings on the product packaging.

## Maintenance

Proper maintenance assures the highest level of safety, durability and dependability for your motorcycle.

- Have your VICTORY dealer perform the break-in maintenance procedures when the motorcycle's odometer registers 500 miles (800 km).
- Perform the recommended periodic maintenance at the intervals specified in the periodic maintenance table beginning on page 55.

## Road Tests

Before returning the motorcycle to regular use after performing service, road test it in a safe environment. Pay special attention to the proper fit and operation of all serviced components. Make any corrections or additional adjustments necessary to ensure safe vehicle performance.

## Break-In Maintenance

Have your VICTORY dealer perform the break-in maintenance procedures when the motorcycle's odometer registers 500 miles (800 km). Performing the break-in maintenance will help ensure optimum engine performance for the entire service life of the engine. Your dealer will change engine oil, inspect all fluids and serviceable components, ensure that all fasteners are tightened and make other adjustments as needed.

## Major Maintenance

For major repair information, refer to the *VICTORY Service Manual*. Major repairs typically require technical skills and specially designed tools. Emission system service requires special tools and training and should be performed by your dealer.

## Periodic Maintenance

Inspect, clean, lubricate, adjust and replace parts as necessary. When inspection reveals the need for replacement parts, use genuine VICTORY parts available from your VICTORY dealer. Record service and maintenance information in the Maintenance Log beginning on page 56.

Perform maintenance at the intervals specified in the periodic maintenance table beginning on page 55. Perform the procedures more frequently if normal use of the motorcycle includes:

- high speed operation for extended periods
- low speed operation for extended periods
- operation in dusty or otherwise adverse conditions

## Periodic Maintenance Table

Component	Page	Odometer Reading in Miles (Kilometers)													
		500 (800)	5000 (8000)	10000 (16000)	15000 (24000)	20000 (32000)	25000 (40000)	30000 (48000)	35000 (56000)	40000 (64000)	45000 (72000)	50000 (80000)			
Air Filter	58	I	I	R	I	R	I	R	I	R	I	R	I	R	
Battery	75	I	I	I	I	I	I	I	I	I	I	I	I	I	
Brake Fluid	72	I	I	I	I	I	I	I	R	I	I	I	I	I	
Brake Pads	41	I	I	I	I	I	I	I	I	I	I	I	I	I	
Clutch Cable	70	I	I	L	I	L	I	L	I	L	I	L	I	L	
Clutch Lever (Mechanical)	69 70	L	I	L	I	L	I	L	I	L	I	L	I	L	
Control Cables	69 70	I	I	L	I	L	I	L	I	L	I	L	I	L	
Crankcase Vent	67	I	I	I	I	I	I	I	I	I	I	I	I	I	
Drive Belt	60	I	I	I	I	I	I	I	R	I	I	I	I	I	
Drive Belt Adjustment	63	P	Adjust with each tire change thereafter												
Engine Oil & Filter*	57	R	R	R	R	R	R	R	R	R	R	R	R	R	
Evaporative Emission Control System (if equipped)	67	I	I	I	I	I	I	I	I	I	I	I	I	I	
Exhaust System	81	I	I	I	I	I	I	I	I	I	I	I	I	I	
Fasteners	77	I	I	I	I	I	I	I	I	I	I	I	I	I	
Front Brake Lever	72	L	L	L	L	L	L	L	L	L	L	L	L	L	
Front Fork Oil**	66	I	I	I	R	I	I	R	I	I	R	I	I		
Front Fork / Axle	66	I	I	I	I	I	I	I	I	I	I	I	I	I	
Fuel System	67	I	I	I	I	I	I	I	I	I	I	I	I	I	
Fuel Filter	-	Please see your dealer for this service.								R					
Headlamp	78	I	I	I	I	I	I	I	I	I	I	I	I	I	
Ignition Switch / Locks	76	I	L	L	L	L	L	L	L	L	L	L	L	L	
Radio/Radio Software	100	Update annually. Please see your dealer.													
Rear Wheel Align	63	I	I	I	I	I	I	I	I	I	I	I	I	I	
Rear Shock	64	I	I	I	I	I	I	I	I	I	I	I	I	I	
Rear Brake Pedal	71	I	I	L	I	L	I	L	I	L	I	L	I	L	
Road Test	82	P	P	P	P	P	P	P	P	P	P	P	P	P	
Sidestand	77	I	I	L	I	L	I	L	I	L	I	L	I	L	
Sidestand Pad	43	I	I	I	I	I	I	I	I	I	I	I	I	I	
Spark Plugs	74	I	I	I	I	I	I	I	R	I	I	I	I	I	
Steering Head Bearings	66	I	I	I	L	I	I	L	I	I	I	L	I	I	
Swingarm	65	I	I	I	I	I	I	I	I	I	I	I	I	I	
Throttle Cable	<\$elemenum	I	I	L	I	L	I	L	I	L	I	L	I	L	
Tires	73	I	I	I	I	I	I	I	I	I	I	I	I	I	

**Maintenance Key:** I = Inspect, clean, adjust, correct or replace if necessary; P = Perform; R = Replace / Rebuild  
 L = Lubricate w/ proper lubricant; \* = Replace at specified interval or annually; \*\* = Replace as specified or every 2 years



## Engine Oil / Filter Change

Change the engine oil at the intervals specified in the periodic maintenance table beginning on page 55.

1. Start the engine and allow it to idle for several minutes. Stop the engine.

**Tip:** The engine must be at normal operating temperature before changing the oil.

**CAUTION!** Hot engine and exhaust components can cause burns to skin and can ignite a fire if exposed to flammable materials. Always park the motorcycle clear of flammable materials and where people are not likely to contact hot components.

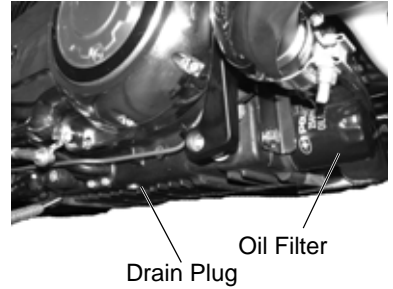

2. Position the motorcycle securely on the sidestand.
3. Place a drain pan under the drain plug and oil filter. Remove the drain plug and seal. Allow the oil to drain completely.

**Tool:** 6 mm Allen wrench

4. Slowly loosen the oil filter. Allow the oil to drain completely.

**Tool:** 2 1/2 inch (63.5 mm) oil filter wrench

5. Clean the drain plug sealing surface on the crankcase. Reinstall the drain plug with a new seal. **DO NOT** overtighten.

**Torque:** 15 ft-lbs (20 Nm)

6. Clean the oil filter mounting threads and gasket sealing surface on the crankcase. Make sure the new oil filter gasket is properly seated in the new oil filter. Apply a thin film of clean engine oil to the gasket. Screw the new filter on until the gasket contacts the sealing surface. Tighten the filter by hand an additional 3/4 turn.
7. Remove the oil fill cap/dipstick. Add approximately 4.5 quarts (4.25 liters) of the recommended oil. Reinstall the oil fill cap.

**NOTICE:** Do not add chemical additives to the engine oil. Some automotive engine oils contain additives that could damage or reduce the service life of the wet clutch in your motorcycle.

8. Start the engine and allow it to idle for several minutes. Stop the engine.

**NOTICE:** After an oil change, the low oil pressure indicator remains illuminated longer than usual before going out. Revving the engine while the low oil pressure indicator is illuminated can damage the engine.

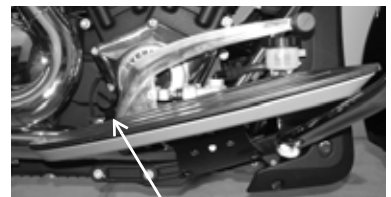

Oil Check/Fill

9. Check for leaks around the drain plug and oil filter.
10. Check the oil level and adjust if needed.
11. Recycle the used oil and filter properly.

Engine Oil Capacity at Oil Change (including filter)	4.5 qt. (4.25 liter) (approximately)
Engine Oil Capacity at Oil Change (not including filter)	4.0 qt. (3.8 liter) (approximately)

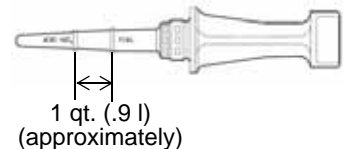

# Maintenance

## Air Filter

Inspect the air filter often if riding in unusually wet or dusty conditions. Do not apply air filter oil to this air filter.

1. Remove the fuel tank. See page 58.
2. Loosen the three filter retainer screws.
3. Loosen the two air filter mounting screws only until the filter can be removed. *Do not remove the screws from the filter.*
4. Remove the filter by pulling upward and rearward.
5. Clean the filter sealing surface on the frame.
6. Install the new air filter.
7. Tighten the mounting screws, then tighten the retainer screws.

**Torque: 36 in-lbs (4 Nm)**

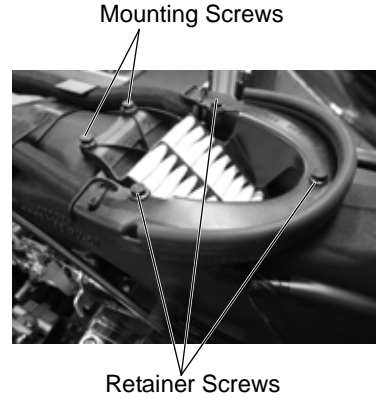

## Fuel Tank Removal / Installation

Before beginning, be prepared to place the fuel tank in a secure location with a drain pan positioned to catch any fuel that may leak or drip from disconnected hoses or fittings.

1. Remove the seat and both side covers.
2. Remove the right side access cover.
3. With the engine and exhaust cool, wrap a clean shop towel around the fuel line fitting at the fuel rail. Disconnect it from the fuel rail by squeezing both release buttons simultaneously. Gently slide the fitting from the fuel rail.

**NOTICE:** Fuel can damage painted surfaces and plastic parts. Wipe up spilled fuel immediately using a clean, dry, soft cloth.

4. At the rear of the tank, disconnect the tank vent hose and the water drain hose.
5. Remove the ground wire screw.
6. Remove the tank mounting screws. Collect all grommets and bushings for reassembly.

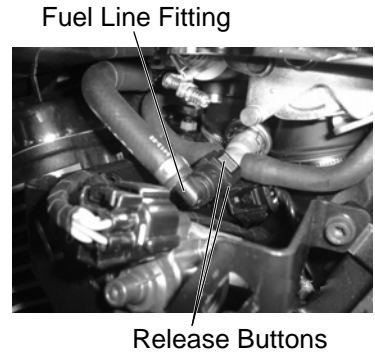

## Fuel Tank Removal / Installation

7. Place the handlebars in the straight ahead position.

**NOTICE:** DO NOT rest the fuel tank on the frame while removing it. Fuel pump fitting damage can occur.

8. Lift the rear of the tank to locate the fuel pump electrical connector. Disconnect the connector by lifting the tab slightly.
9. With the rear of the tank lifted, also disconnect the fuel line from the fuel pump by squeezing both release buttons simultaneously. Gently slide the fitting from the fuel pump.
10. Lift the rear of the fuel tank as high as clearance at the front of the tank will allow to ensure adequate clearance for the fuel line fitting under the tank.
11. With the rear of the fuel tank raised, *carefully* slide the tank rearward and off the front mounts.
12. When the tank is clear of the front mounts, lift the tank up and away from the frame. Be prepared to catch dripping fuel in an appropriate container.
13. To reinstall the fuel tank, reverse the removal steps, routing the fuel line along the right edge directly to the fuel rail.

**NOTICE:** The 90-degree fuel pump fitting can be damaged if improperly installed. The fitting must point toward the rear of the bike when installing the tank. If the tank does not align with the rear frame mounts, do not force it into position. Verify the orientation of this fitting.

14. Install the grommets and bushings in each rear mount and install the bolts. If necessary, use soapy water or rubber lubricant to lubricate the grommets. Tighten the bolts.

**Torque: 18 ft-lbs (24.4 Nm)**

15. Connect the vent and drain hoses, then connect the fuel line at the fuel rail. Listen for a click to ensure the line is secured properly.
16. Install the ground wire connection and screw.  
**Torque: 8 ft-lbs (11 Nm)**
17. Prime the fuel pump. See page 45.
18. Check for leaks.
19. Reinstall the access cover, side covers and seat.

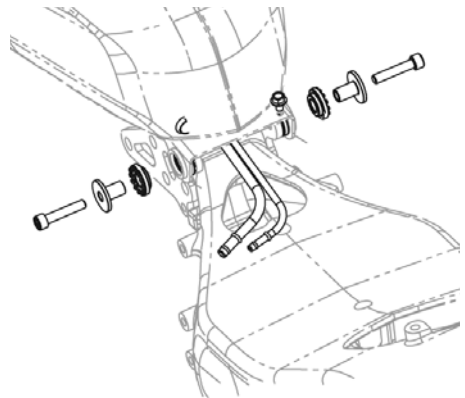

# Maintenance

## Drive Belt Condition

Replace the drive belt if it is cracked or has broken teeth or frayed edges. No matter its condition, the drive belt should be replaced at periodic intervals. See the *VICTORY Service Manual* or an authorized VICTORY dealer.

DO NOT attempt to check belt tension if the belt has been exposed to rain or washing within a 24 hour period or if the belt is hot from riding. Allow the belt to cool down to ambient temperature before measuring belt tension. Replace the drive belt and both sprockets as a set if the drive belt has over 5,000 miles (8,000 km) of service at the time of damage or failure.

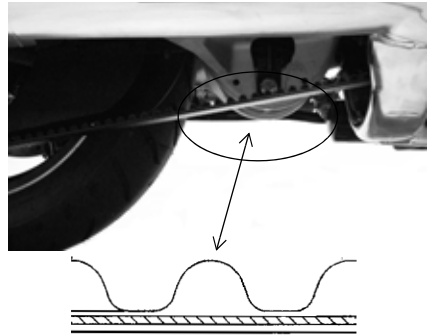

## Drive Belt Wear Analysis

<p>Internal tooth cracks (hairline): OK to run, but monitor condition</p>	<p>External tooth cracks: Replace belt</p>	<p>Missing teeth: Replace belt</p>	<p>Chipping (not serious): OK to run, but monitor condition</p>
<p>Fuzzy edge cord: OK to run, but monitor condition</p>	<p>Hook wear: Replace belt</p>	<p>Stone damage: Replace belt if damage is on edge</p>	<p>Bevel wear (outboard edge only): OK to run, but monitor condition</p>



## Drive Belt Tension Data

Specifications are listed below for deflection and sonic tension. Sonic tension measurement requires Gates Sonic Tension Meter 507C or an equivalent.

### Drive Belt Deflection (Using PV-43532 Tension Gauge)

Deflection	
CROSS ROADS	CROSS COUNTRY
32 mm ± 0.5 mm	32 mm ± 0.5 mm

### Drive Belt Sonic Tension (Using Sonic Tension Meter)

Required Data		Sonic Tension	
		CROSS ROADS	CROSS COUNTRY
Span	708.6	20 Hz ± 1	20 Hz ± 1
Belt Width	28 mm		
Belt Mass Constant	8.4		

## Drive Belt Tension Inspection

On new drive systems or belt, adjust belt tension after the first 500 miles (800 km). Adjust tension at each tire change thereafter.

**Tip:** Do not inspect or adjust drive belt tension when the belt is wet. Improper adjustment will result.

Checking drive belt tension involves using the belt tension gauge (P/N PV-43532). You can also use a Sonic Tension Meter if available. Before beginning this procedure:

- Make sure the drive system is clean, *dry*, and at *room temperature* (belt and sprockets).
- Be sure suspension is properly adjusted.
- Belt tension must be adjusted at the tightest spot.

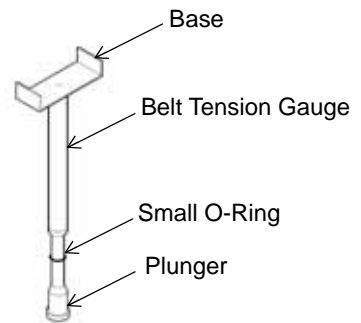

# Maintenance

## Drive Belt Tension Inspection

1. Elevate and support the motorcycle with the rear tire slightly off the floor.

**CAUTION!** Make sure the motorcycle is stable when elevated. Injury may occur if the motorcycle tips or falls.

2. Place the transmission in neutral.
3. Rotate the rear wheel in a forward direction until the valve stem is at the bottom. This is your reference point for determining the tight spot to make your adjustment (if necessary).
4. Position the small O-ring on the tension gauge directly over the 10 lbs. mark on the plunger.
5. Place a tape measure or steel rule next to the drive belt, mid-way between the sprockets. Support the rule or tape so it does not move.
6. Note the graduation mark on the rule that aligns with the lower edge of the belt. This position represents *zero force*.
7. Place the support base of the tension gauge squarely against the lower surface of the belt as close as possible to the rule or tape.
8. Keeping the tension gauge perpendicular to the belt surface and parallel with its length, push the plunger upward until the small O-ring touches the tension gauge body.
9. Be sure the tension gauge is seated squarely against the belt, and note the graduation mark on the rule that now aligns with the lower edge of the belt. This position represents *10 lbs. force*.
10. To calculate belt tension (deflection) subtract the smaller measurement from the larger measurement and record it.

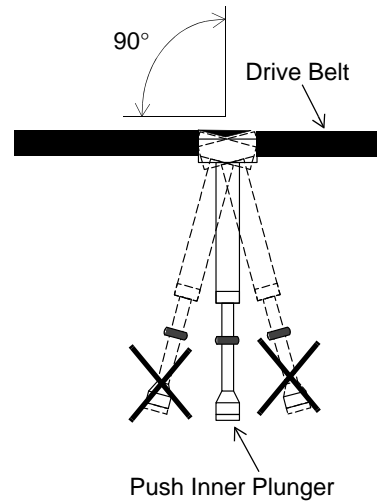
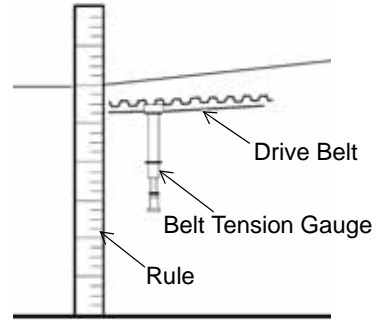

### Determine The Tightest Spot

11. Repeat the above deflection measurements with the tire's valve stem at the rear most position, top, and front most positions (90 degrees rotation each time), recording each measurement.
12. If the *tightest* measurement is not within the recommended range (see page 61), belt tension must be adjusted.

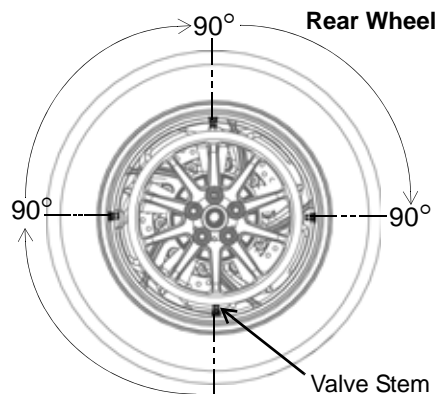

## Drive Belt Tension Adjustment

1. Move the wheel to the tight spot location determined previously.
2. Loosen the rear axle nut on the left side.
3. Turn each axle adjuster nut *clockwise* an equal amount to tighten the belt (reduce deflection) or an equal amount *counter-clockwise* to loosen the belt (increase deflection).

**Tool:** 13 mm deep socket

4. Tighten the rear axle nut.  
**Torque: 65 ft-lbs (88 Nm)**
5. Pump the rear brake pedal to re-set the pads against the brake disc.
6. Verify proper belt tension and wheel alignment.

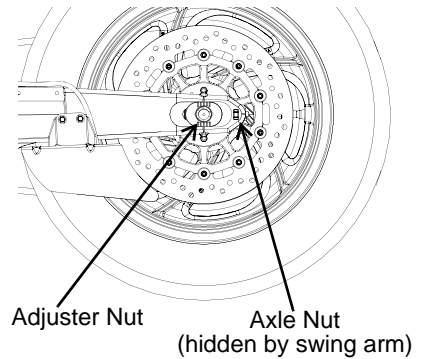

## Drive Belt / Rear Wheel Alignment

1. Look at the alignment reference marks on each side of the swingarm and the marks on the axle plates to verify proper wheel alignment. Axle plate mark to reference mark alignment must be the same on both sides.
2. If the marks are not aligned, perform all steps of the Belt Tension Adjustment procedure. See page 63.
3. Before and after tightening the axle nut, verify proper belt tension and wheel alignment.

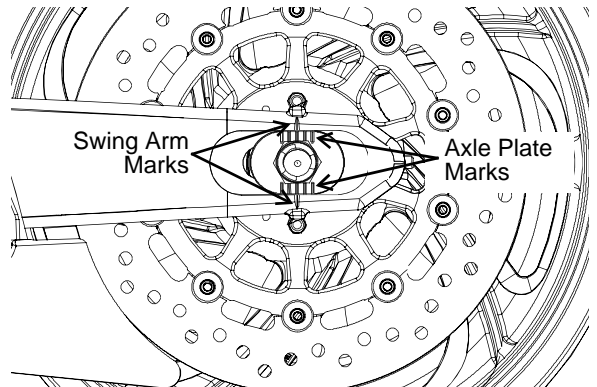

## Drive Belt Cleaning

Cleaning the drive belt will maximize belt and sprocket life and minimize drive line noise. Clean the belt at every tire change. Clean the belt more often if riding in dirty, dusty or high debris environments.

1. Mix a few drops of mild dish soap with a cup of warm water.
2. Use a soft nylon brush to clean the belt and sprocket teeth with the soapy water. Clean well in corner areas where road debris and belt dust can collect.
3. Rinse the belt with clear water, then dry thoroughly.

**Tip:** Do not inspect or adjust drive belt tension when the belt is wet. Improper adjustment will result.

# Maintenance

## Rear Suspension Adjustment

For riding comfort and to ensure proper ground clearance, adjust rear shock air pressure as specified on the label located in the right saddlebag cover (reproduced below).

Shock Label



Follow these guidelines when adjusting:

- Park the motorcycle with the sidestand down on a firm, level surface. Remove all riders and cargo.
- DO NOT exceed 72 PSI (496 kPa) in the shock.
- Use the VICTORY Air Pump and Gauge (P/N 2876654). Follow the instructions on the following pages.

If the VICTORY air pump and gauge are not available, use the gauge provided in the tool kit, and a pressurized air source with a maximum line pressure of 72 PSI (496 kPa). After using this gauge, remove it quickly to minimize leakage. Expect to lose about 4 PSI (27.6 kPa) with each pressure check when using this gauge. *Use only a dry air source*, such as a system with a water separator or air line dryer, to prevent moisture from entering the shock.

**CAUTION!** Air pressure increases VERY quickly when using pressurized air. Wear eye and face protection.

Air Suspension Adjustment (Shock Label 7176835)		
Set desired pressure with bike <u>unloaded</u> on side stand		
Total Cargo & Occupant Weight (lbs)	Air Pressure (psi)	
	No Trunk	Trunk
100	0	0
125	0	0
150	0	0
175	0	9
200	0	15
225	9	25
250	15	29
275	25	34
300	29	39
325	34	45
350	39	52
375	45	58
400	52	65
425	58	70
450	65	72
475	70	72
500	72	72

## Rear Suspension Adjustment

1. Park the motorcycle with the sidestand down on a firm, level surface. Remove all riders and cargo.
2. Remove the right side cover. Remove the cap from the air fitting.
3. Refer to the shock label to determine the recommended air pressure.
4. Install the hose fitting of the recommended gauge securely onto the air fitting. Read the air pressure on the gauge.

**Tip:** A small oil leak from the air fitting is acceptable when pressure is adjusted. See your dealer if more than 5 cc of oil leaks from the fitting.

5. To *reduce* air pressure, push the bleed button on the gauge. Bleed pressure in small amounts until the desired pressure is attained.
6. To *increase* pressure, pump the handle until pressure increases to the desired amount.

**CAUTION!** DO NOT exceed 72 PSI (496 kPa) in the shock.

7. Remove the hose from the air fitting and reinstall the cap.

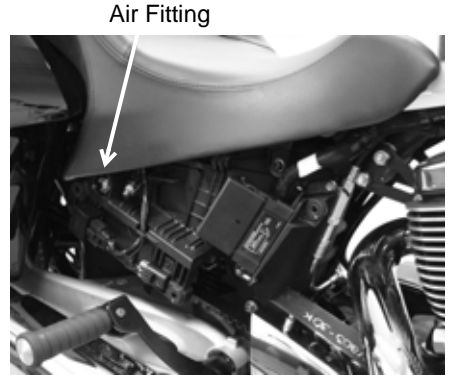

## Swing Arm / Rear Axle Inspection

1. Sit in the operator's seat and slowly bounce the rear suspension a few times. Make sure the suspension moves freely without binding. Listen for abnormal noises.
2. Elevate and support the motorcycle with the rear tire slightly off the floor.

**CAUTION!** Make sure the motorcycle is stable when elevated. Injury may occur if the motorcycle tips or falls.

3. Grasp the rear-most surface of the rear tire and attempt to move the wheel side-to-side. If there is movement at the front of the swingarm, check the swingarm pivot nut torque and swingarm pivot bearings.
4. Contact your VICTORY dealer for service if you detect noise or movement at the swingarm pivot.
5. Grasp the top or bottom surface of the tire and try to move it side to side. If there is movement at the rear axle, inspect wheel bearings and rear axle nut torque.
6. Contact your VICTORY dealer for service if you detect noise or movement at the wheel bearings.
7. With the transmission in neutral, slowly rotate the rear wheel. If the wheel does not rotate smoothly, inspect the wheel bearings, rear axle, belt adjustment and wheel alignment. See the *VICTORY Service Manual* or your authorized VICTORY dealer.

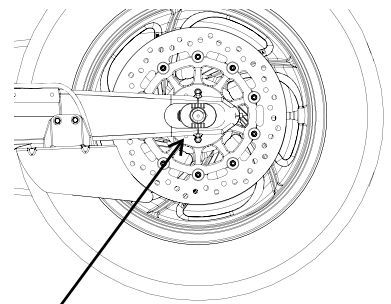

Check for movement in wheel bearing area

# Maintenance

## Front Fork / Suspension Inspection

1. Place the motorcycle on the sidestand and inspect the front forks. If fork oil is present on the outer tube, *do not ride the motorcycle*. See your dealer for service before operating. If fork oil is present around the fork seals or inner tubes, replace the fork seals.
2. Clean the fork tubes to remove bugs, tar or buildup which may cause seal wear or leakage. Inspect the outer surfaces of the inner fork tubes for scratches or damage from foreign objects.
3. Straddle the motorcycle and bring it to the fully upright position. Apply the front brake and push downward (hard) on the handlebars several times. The front suspension should operate smoothly and quietly.
4. Fork oil condition and level affects front suspension performance and internal component wear. Replace fork oil at the recommended intervals. Special tools are required to perform this procedure. See the *VICTORY Service Manual* or your authorized VICTORY dealer.



Fork Inner Tube

## Steering Head Inspection

1. Elevate and support the motorcycle with the front tire slightly off the floor.

**CAUTION!** Make sure the motorcycle is stable when elevated. Injury may occur if the motorcycle tips or falls.

2. Turn the handlebars from stop to stop. The action should be smooth but not loose. Make sure wires, hoses and control cables do not interfere with smooth steering.
3. Position the front wheel straight ahead. Grasp the front forks near the front axle and attempt to move the wheel front-to-back. If there is front-to-back movement at the steering head, see your VICTORY dealer for service.

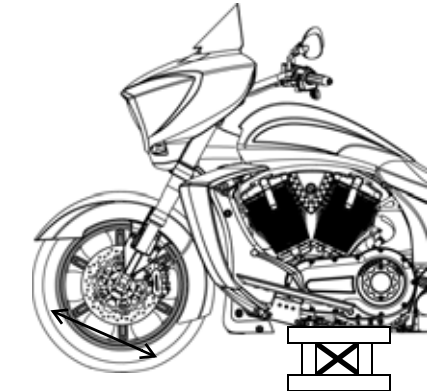

## Evaporative Emission Control System (California Models)

1. Inspect all evaporative emission control system hoses and connections. Make sure all connections are tight.
2. Inspect connections at the evaporative emissions canister to be sure they are secure. The canister is located under the rear fender.

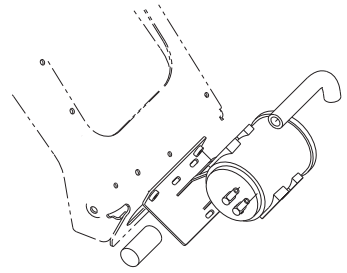

Evaporative Emissions  
Canister (California Models)

## Fuel System Components

1. Inspect fuel hoses for cracks or damage.
2. Inspect hose connections at the fuel tank and at the fuel rail for dampness or stains from leaks.

## Fast Idle

A fast idle speed during warm up of between 1200 and 2000 RPM is automatically set by the EFI system Idle Air Control (IAC). Periodic adjustment is not required.

## Crankcase Breather Hose

Inspect the crankcase breather hose for cracks or damage. Be sure the clamps are in place and secure.

Breather Hose



# Maintenance

## Throttle Control Inspection

1. With the engine OFF, rotate the throttle control grip fully open and then release it. It should rotate smoothly from the rest position to the completely open position. It should return to the rest position quickly when released.
2. Repeat the twist and release process with the handlebars turned fully *right* and fully *left*.

**NOTICE:** To prevent damage to the throttle system, always operate with the throttle cable guard installed.

3. Remove the right side access cover.
4. Inspect throttle cables for frayed ends.
5. Service the throttle system if throttle operation is not smooth, if throttle grip does not return properly, or if cable ends are frayed. See the *VICTORY Service Manual* or your authorized *VICTORY* dealer.

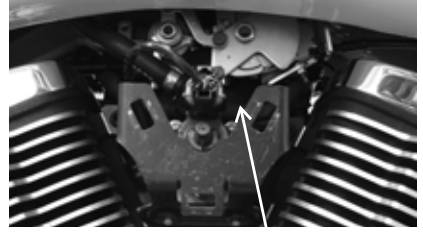

Cable Area

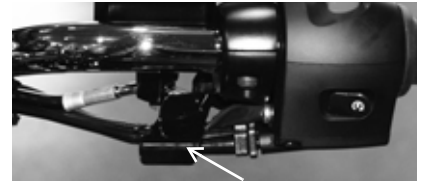

Throttle Cable Guard

## Throttle Cable Freeplay

Throttle freeplay is the amount of throttle control grip movement from the rest position to the point of cable resistance. Measure this distance. Freeplay should be 2-4 mm. Adjust throttle freeplay as needed.

1. Position the front wheel straight ahead. Stop the engine.
2. Hold the adjuster nuts securely and loosen the lock nuts on both cables. Turn the lock nuts away from the adjuster nuts as far as possible.
3. Turn both adjuster nuts toward the lock nuts as far as possible for maximum freeplay in both cables.
4. Turn the adjuster on the throttle opening cable (front cable) away from the lock nut until throttle freeplay is 2-4 mm.
5. To adjust the closing cable (rear cable), hold the throttle grip lightly in the closed position. Turn the adjuster slowly outward until slight resistance is felt.
6. Turn the lock nuts on both cables until they are seated against the adjuster nuts. Hold each adjuster nut and tighten each lock nut securely.
7. Repeat the throttle control inspection. See page 68.



2-4 mm to resistance



Adjuster Nut      Lock Nut



## Cruise Control Cable Inspection (if equipped)

1. Remove the right side access cover.
2. Inspect the throttle body end of the cruise control cable for fraying and be sure the end is secured in the bracket.

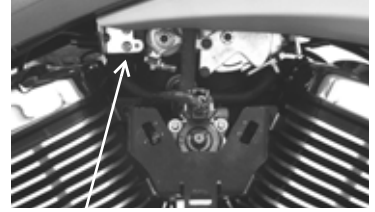

Cruise Control Cable

## Throttle Cable Lubrication

Lubricate control cable ends at the intervals recommended in the periodic maintenance table beginning on page 55.

**NOTICE:** External casings are factory-lubricated. Additional lubrication could be detrimental to cable performance.

Verify proper routing and smooth movement. Inspect for damage to the external casing, and inspect exposed cable wire for fraying, kinks or corrosion. Replace any damaged, sticky or sluggish cable.

1. Disconnect the cable at the throttle body.
2. Apply a light film of VICTORY All Purpose Grease or equivalent to the barrel end.
3. Reconnect the cable and adjust freeplay as needed.

## Mechanical Clutch Lever Freeplay

1. Remove the right side access cover.
2. Hold the clutch cable and loosen the adjuster lock nut.
3. While holding the cable, turn the cable adjuster inward or outward until clutch lever freeplay is 0.5-1.5 mm.
4. While holding the cable, tighten the adjuster lock nut securely.
5. Reinstall the right side cover.
6. Verify that the safety switch activates properly. The engine should not start in gear with the clutch lever released.



0.5-1.5 mm  
Freeplay

**Tip:** The starter interlock switch is dependent on the clutch lever freeplay being set correctly to ensure activation of the clutch safety switch.

# Maintenance

## Mechanical Clutch Lever Lubrication

1. Remove the right side access cover. Loosen the clutch cable adjuster lock nut.
2. Turn the cable adjuster completely inward to provide maximum lever freeplay.
3. Remove the clutch lever pivot nut and screw. Disconnect the clutch cable from the clutch lever.
4. Remove any old grease and dirt from the lever and housing. Lubricate the clutch lever and pivot screw with VICTORY Moly Assembly Grease or VICTORY All Purpose Grease.
5. Reconnect the clutch cable. Reinstall the lever, pivot screw and nut. Hold the screw down and tighten the nut.  
**Torque: 40 in-lbs (5 Nm)**
6. Adjust clutch lever freeplay. See page 69.

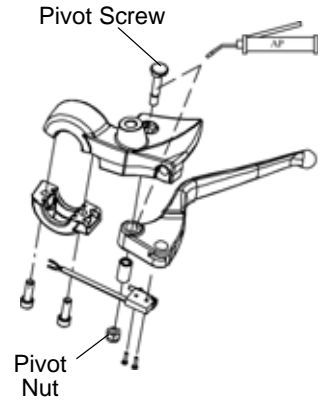

## Mechanical Clutch Cable Lubrication

Lubricate control cable ends at the intervals recommended in the periodic maintenance table beginning on page 55.

**NOTICE:** External casings are factory-lubricated. Additional lubrication could be detrimental to cable performance.

Verify proper routing and smooth movement. Inspect for damage to the external casing, and inspect exposed cable wire for fraying, kinks or corrosion. Replace any damaged, sticky or sluggish cable.

1. Disconnect the cable at the clutch lever and at the primary cover.
2. Lubricate the barrel ends with VICTORY All Purpose Grease or equivalent.
3. Reconnect the cable and adjust freeplay as needed.

## Rear Brake Pedal

1. See page 34 for rear brake pedal adjustments.
2. Lubricate the pivot bushing at the intervals recommended in the periodic maintenance table beginning on page 55. Also lubricate any time binding is evident. Use VICTORY All Purpose Grease or equivalent.
3. Inspect brake pads as outlined on page 41.

## Brake Fluid Precautions

### ⚠ WARNING

Using the wrong fluid or allowing air or contaminants into the fluid system can damage the system seals or result in a malfunction that could lead to serious injury or death. Use only DOT 4 brake fluid from a sealed container.

Do not operate the front brake with the reservoir cover removed. Fluid could overflow from the reservoir and allow air to enter the system. Air in the brake system could cause the brakes to malfunction.

An over-full reservoir may cause brake drag or brake lock-up, which could result in serious injury or death. Maintain brake fluid at the recommended level. Do not overfill.

**NOTICE:** Brake fluid will damage painted surfaces and plastic parts. Always clean spilled brake fluid immediately with water and a mild detergent.

## Rear Brake Fluid

1. Position the motorcycle on level ground in the fully upright position.
2. The rear brake fluid reservoir is located near the rear brake pedal, just inside the right lower leg fairing. Wipe the fluid container and the area around the reservoir cover with a clean cloth.
3. If the fluid level is low, inspect brake pads as outlined on page 41. If pads are not worn beyond the service limit, inspect the brake system for leaks.
4. To add fluid, remove the reservoir cover. Carefully add fluid to the recommended level. *Do not overfill.*
5. Reinstall the cover and diaphragm.
6. Wipe away any fluid spills. Check for signs of brake fluid leaks around hoses, fittings, reservoir, and brake calipers.

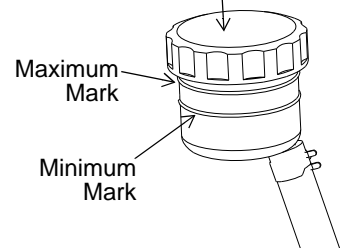
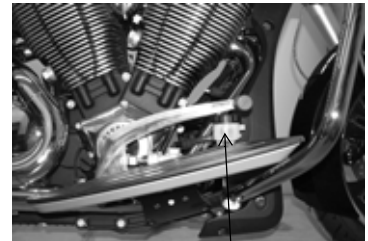

# Maintenance

## Front Brake Lever

1. See page 33 for front brake lever reach adjustments.
2. Lubricate the pivot bushing at the intervals recommended in the periodic maintenance table beginning on page 55. Also lubricate any time binding is evident. Use VICTORY All Purpose Grease or equivalent.
3. Inspect brake pads as outlined on page 41.



Brake Lever Bushing

## Front Brake Fluid

Change the brake fluid at the intervals recommended in the periodic maintenance table beginning on page 55.

1. Straddle the motorcycle and bring it to the fully upright position. Position the handlebars so that the fluid reservoir is level. Wipe the fluid container and the area around the reservoir cover with a clean cloth.
2. If the fluid level is low, inspect brake pads as outlined on page 41. If pads are not worn beyond the service limit, inspect the brake system for leaks.
3. To add fluid, remove the three reservoir cover screws. Remove the cover and diaphragm. Carefully add fluid to the top of the sight glass. *Do not overfill.* Reinstall the diaphragm, cover and screws.

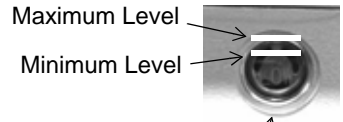

**Torque: 25 in-lbs (3 Nm)**

4. Wipe away any fluid spills. Check for signs of brake fluid leaks around hoses, fittings, reservoir, and brake calipers. Check for deterioration of hoses.

## Brake Disc Inspection / Cleaning

1. Inspect brake pads as outlined on page 41.
2. Inspect brake discs for nicks, scratches, cracks or other damage. Inspect the thickness of each brake disc at four or more locations around the disc. If any disc is worn to the minimum thickness at the thinnest point, or if a disc is damaged, see your VICTORY dealer for replacement.
3. Clean discs if minor squeaks develop due to dirt or dust. Apply VICTORY Brake Cleaner (P/N 2872191) to a clean shop towel and wipe disc. DO NOT allow brake cleaner to contact painted or plastic parts. Read all precautions on the label.

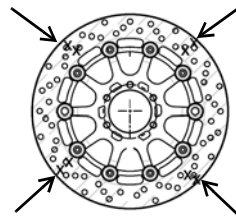

**Minimum Thickness**  
Front: 4.5 mm  
Rear: 6.5 mm



## Brake Hoses / Connections

Inspect all brake hoses and connections for dampness or stains from leaking or dried fluid. Tighten any leaking connections and replace components as necessary. See the *VICTORY Service Manual* or your authorized VICTORY dealer.

## Wheel Inspection

Inspect both wheels for cracks or damage and replace damaged wheels promptly. Do not operate the motorcycle if wheels are damaged or cracked. See the *VICTORY Service Manual* or your authorized VICTORY dealer.

## Tires

### **▲ WARNING**

Operating the motorcycle with improper tires or with improper or uneven tire pressure could cause loss of control or accident. Always use the correct size and type of tires specified for your vehicle. Always maintain proper tire pressure as recommended in the owner's manual and on safety labels.

### **Tire Condition**

Inspect the tire sidewalls, road contact surface, and tread base for cuts, punctures, and cracking. Replace damaged tires immediately. See the *VICTORY Service Manual* or an authorized VICTORY dealer.

### **Tire Tread Depth**

Use a depth gauge or an accurate ruler to measure the depth of the center tire tread on both front and rear tires. Replace the tire if the tread depth is less than 1/16 inch (1.6 mm).



# Maintenance

## Tires

### Tire Pressure

Riding warms the tires and increases tire air pressure. For an accurate reading, check tire pressure before riding. Adjust tire pressure as recommended for the total weight of your intended load (see table).

**WARNING!** Do not exceed the maximum recommended inflation pressure to seat the bead. Tire or rim failure may result.

Location	Size	Brand	Type	Recommended Pressure	
				Load Weight up to 200 lbs (91 kg)	Load weight up to vehicle's maximum load capacity
Front	130/70R18 63H	Dunlop	Elite 3	36 psi (248 kPa)	38 psi (262 kPa)
Rear	180/60R16 M/C 80H	Dunlop	Elite 3	38 psi (262 kPa)	40 psi (276 kPa)

## Spark Plugs

Replace spark plugs at the intervals recommended in the periodic maintenance table beginning on page 55. Always replace spark plugs in pairs.

Spark Plug Specifications	
Spark Plug Type	NGK DCPR6E
Spark Plug Gap	.031-.035 inch (0.8-0.9 mm)
Spark Plug Torque	10.8-14.5 ft-lbs (14.6-19.7 Nm)



1. Make sure the engine is at room temperature.
2. Pull upward on the spark plug boot (not the wire) to remove the boot.

**CAUTION!** Wear eye and face protection when using pressurized air.

3. To prevent debris from entering the spark plug hole, use compressed air to clean the area around the plugs before removing them. Remove the spark plugs.

**Tool:** 12 mm plug socket

**Tip:** Both spark plugs should have the same light or medium tan color deposits. The electrodes should be square with sharp edges.

4. Reinstall the spark plugs or install new plugs. Apply anti-seize compound sparingly to the threads.

## Battery

The motorcycle battery is a sealed, maintenance-free battery. Do not remove the battery cap strip for any reason. Keep the battery connections clean and tight at all times.

### ⚠ WARNING

**Battery electrolyte is poisonous.** It contains sulfuric acid. Serious burns can result from contact with skin, eyes or clothing.

Antidote:

**External:** Flush with water.

**Internal:** Drink large quantities of water or milk. Follow with milk of magnesia, beaten egg, or vegetable oil. Call physician immediately.

**Eyes:** Flush with water for 15 minutes and get prompt medical attention.

**Batteries may produce explosive gases.**

- Keep sparks, flame, cigarettes, etc. away.
- Ventilate when charging or using in an enclosed space.
- Always shield eyes when working near batteries
- KEEP OUT OF REACH OF CHILDREN.

## Battery Removal

1. Remove the two upper and two lower screws from the front chin fairing. Remove the fairing.

**WARNING!** Improperly connecting or disconnecting battery cables can result in an explosion and cause serious injury or death. When removing the battery, always disconnect the negative (black) cable first. When reinstalling the battery, always connect the negative (black) cable last.

2. Remove the negative (-) battery cable from the battery terminal.  
**Tool:** 10 mm wrench
3. Remove the red protective boot from the positive (+) cable end to expose the terminal. Remove the positive cable from the battery terminal.
4. Remove the battery hold-down strap.
5. Remove the battery.

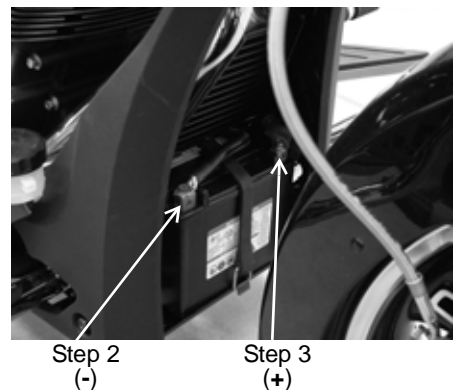

# Maintenance

## Battery Installation

**WARNING!** Improperly connecting or disconnecting battery cables can result in an explosion and cause serious injury or death. When removing the battery, always disconnect the negative (black) cable first. When reinstalling the battery, always connect the negative (black) cable last.

1. Place the battery in the battery compartment with terminals forward.
2. Reinstall the battery hold-down strap.
3. Install the positive (+) cable first.  
**Torque: 36 in-lbs (4 Nm)**
4. Install the red protective boot over the terminal.
5. Install the negative (-) cable last.  
**Torque: 36 in-lbs (4 Nm)**
6. Reinstall the front chin fairing. Tighten all four screws.  
**Torque: 36 in-lbs (4 Nm)**

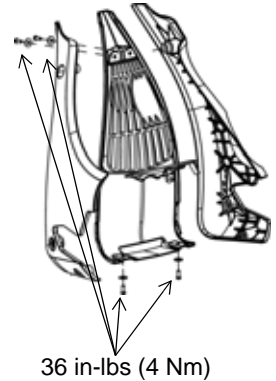

## Battery Charging

**Tip:** If your VICTORY motorcycle will not be used for a period of 6 weeks or longer, a maintenance charger should be connected to the battery. A fused maintenance charger connection is provided. The connector is designed for use with the VICTORY accessory maintenance charger available at your authorized VICTORY dealer.

1. Following the charger manufacturer's instructions, use a battery charger designed for use with 12-volt batteries. The charger should have a maximum charging rate of 1.8 amps. Charge the battery for approximately 10 hours at a rate of 1.8 amps. If you use a taper or trickle charger, it will take longer to charge the battery.
2. After charging the battery, allow the battery to sit 1-2 hours before checking the state of charge with a DC volt meter. The charge should be a minimum of 12.5 DC volts. Repeat the charging cycle if the charge is less than 12.5 DC volts. Replace the battery if it fails to reach 12.5 volts after the second charge.

## Ignition Switch / Lock Lubrication

Periodically lubricate the ignition switch, saddle bag locks and fuel cap lock. We recommend the use of VICTORY Multi-Purpose Lubricant.

1. Spray lubricant directly into the ignition switch and into each lock cylinder for 1-2 seconds.
2. Insert each key into its lock and turn it to all positions to distribute the lubricant.
3. Wipe away any excess lubricant.



## Sidestand Lubrication

Periodically lubricate the sidestand pivot and the ends of the spring. See page 43 for sidestand inspections.

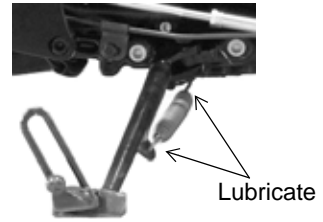

## Fastener Inspection

1. Inspect the entire motorcycle chassis and engine for loose, damaged or missing fasteners. Tighten loose fasteners to the proper torque.

**Tip:** Refer to the specifications section of this manual or the service manual for fastener torque values, or see your VICTORY dealer.

2. Always replace stripped, damaged or broken fasteners before riding. Use genuine VICTORY fasteners of equal size and strength.

## Side Covers

Remove the left side cover to access the electronic control module, diagnostic connector and chassis-to-engine harness connector.

Remove the right side cover to access the fuses, rear suspension air fitting, clutch cable adjuster, purge valve and flasher unit.

Remove both side covers to access the seat screws.

1. Pull outward at each corner of the side cover to disengage the three darts.
2. Remove the side cover from the motorcycle.
3. To reinstall the side cover, make sure each rubber grommet is properly positioned. Align each dart with the appropriate grommet and press inward firmly to secure each dart.

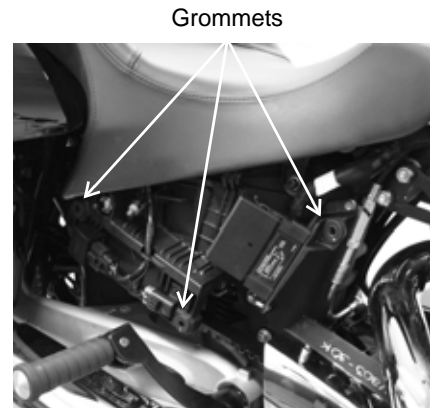

# Maintenance

## Seat Removal / Installation

1. Remove the side covers. See page 77.
2. Remove the two seat screws.  
**Tool:** 6 mm Allen wrench
3. Lift the front of the seat upward and pull forward to disengage the tab at the rear of the seat.
4. To install, reverse the above process, being sure to engage the tab at the back of the seat.
5. Tighten the seat screws.  
**Torque:** 10 ft-lbs (13.5 Nm)

Seat Screws  
10 ft-lbs (13.5 Nm)

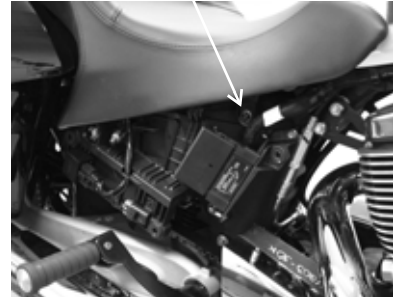

## Headlight Aim Inspection

The top edge of the high beam must be 3 inches (7.6 cm) below the widest part of the headlight and centered straight ahead at 25 feet (7.6 m).

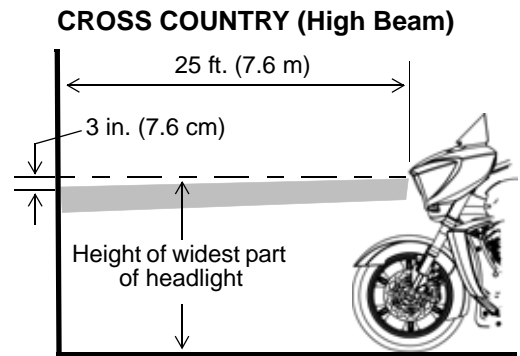
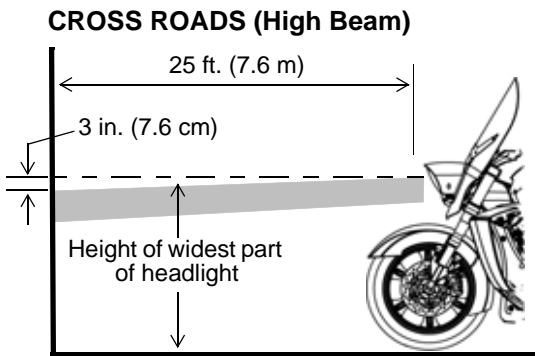

1. Verify that tire pressure is at specification. See page 74.
2. Verify that rear suspension ride height (preload) is at specification. See page 64.
3. Position the motorcycle on a level surface with the headlight 25 feet (7.6 m) from a wall.
4. With the operator and passenger (if applicable) on board, bring the motorcycle to the fully upright position.
5. Move the ignition switch to the ON position and switch the headlamp to high beam. Observe the headlight aim on the wall.
6. Make any necessary adjustments to headlight aim. See page 79.

## Headlight Aim Adjustment (CROSS COUNTRY)

1. To adjust the headlamp vertically, remove the headlight bezel by pulling straight outward at the edges to release the spring clips. Loosen the adjustment screws evenly to adjust the beam downward. Tighten the adjustment screws evenly to adjust the beam upward.
2. To adjust the headlamp horizontally, tighten one screw and loosen the other equally. The beam will adjust to the direction of the tighter screw.
3. Verify proper headlight aim. Readjust if necessary.

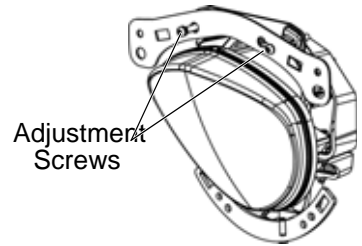

## Headlight Aim Adjustment (CROSS ROADS)

1. To adjust the headlamp, loosen the adjustment nut. Adjust the headlamp vertically or horizontally.
2. Hold the headlamp firmly in position while tightening the nut.  
**Torque: 28 ft-lbs (38 Nm)**
3. Verify proper headlight aim. Readjust if necessary.

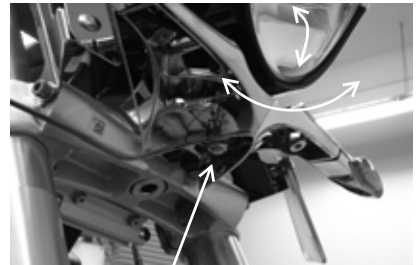

Adjustment Nut

## Headlight Lamp Replacement

### High Intensity Discharge (HID) Lamps (CROSS COUNTRY)

High intensity discharge lamps should be handled only by a trained technician wearing the appropriate protective gear. See the *VICTORY Service Manual* or an authorized VICTORY dealer.

### Halogen Lamps (CROSS ROADS)

1. Unplug the wiring harness from the back of the headlight (lift the tab). Be sure to pull on the connector, not on the wiring.

**Tip:** Avoid touching a halogen lamp with bare fingers. Oil from your skin leaves a residue, causing a hot spot that will shorten the life of the lamp. If a lamp is touched, clean it thoroughly with denatured alcohol.

2. Remove the spent lamp and install a new lamp.
3. Reinstall the wiring harness.

# Maintenance

## Fuse Replacement

**NOTICE:** Use fuses with the recommended amperage to avoid damage to the electrical system.

Fuse Recommendations	
Fuse Application	Fuse Size
Engine	15 amp
Fuel Pump/Ignition Coil	15 amp
Lights	20 amp
Turn Signals/Horn	10 amp
Ignition	10 amp
Chassis	20 amp
Accessory (under left side cover)	20 amp
CROSS COUNTRY ONLY	
Radio (in fairing behind headlight)	25 amp

CHASSIS RELAY	ENGINE RELAY	FUEL PUMP / IGNITION COIL RELAY	PRIMARY LIGHTING RELAY
PRI LIGHTING 20A	ENGINE 15A	FP/IGN COIL 15A	TURN SIGNAL / HORN RELAY
IGNITION 10A	CHASSIS 20A	TS / HORN 10A	

Fuse Box Label

**Tip:** Use the fuse puller provided in the tool kit to remove a fuse.

1. Remove the right side cover.
2. Lift the release tab and slide the fuse box upward to remove it from the bracket. Release the tabs on each side of the fuse box cover and remove the cover.

**Tip:** The reverse fuse (if equipped) is located on the debris flap at the front of the rear tire.

3. Remove the damaged fuse and seat the new fuse firmly in its place.
4. Reinstall the fuse box cover with the double cut-out to the left (with print readable from right side of motorcycle).
5. Reinstall the fuse box and the side cover.

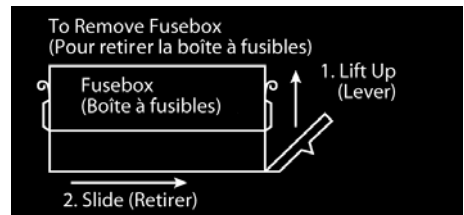
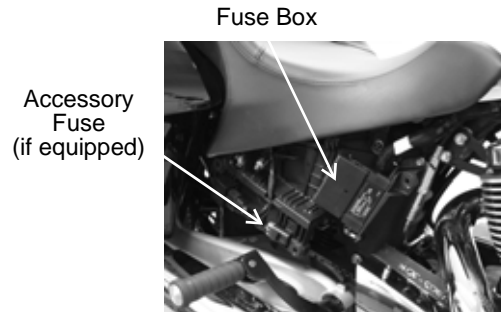

## Electrical Precautions

Be aware of the following precautions regarding the electrical system to avoid disruption of electrical signals and possible system malfunction.

### DO:

- DO use ONLY genuine VICTORY parts and accessories designed for your model and follow the instructions provided.
- DO use the accessory power jack provided (if equipped).
- If it is necessary to provide power to an item that does not use one of the previously mentioned power jacks, connect to the load side of the main circuit breaker (under the cover behind the oil cooler), and connect the ground wire to the engine ground at the front left side of the crankcase (near the circuit breaker).

### DO NOT:

- DO NOT splice or cut any wires.
- DO NOT tap in to any power or ground on the motorcycle unless specifically directed to do so by the VICTORY instructions that come with the kit.
- DO NOT back-probe electrical connectors on the vehicle unless directed to do so by the Service Manual.
- DO NOT power any accessories from the diagnostic connector (under left side cover).

## Engine Compression Test

An engine compression test can be performed to monitor general engine condition. See the *VICTORY Service Manual* or your authorized VICTORY dealer.

## Exhaust System Inspection

Check the exhaust system for stains from leaking exhaust gasses. Replace damaged or leaking exhaust gaskets. See the *VICTORY Service Manual* or your authorized VICTORY dealer.

Check all exhaust system fasteners. Tighten loose clamps and fasteners. Do not overtighten.

### Fastener Torques

1. 12 ft-lbs (16 Nm)
2. 35 ft-lbs (47.5 Nm)
3. 8 ft-lbs (11 Nm)
4. 35 in-lbs (4 Nm)
5. 18 ft-lbs (24 Nm)

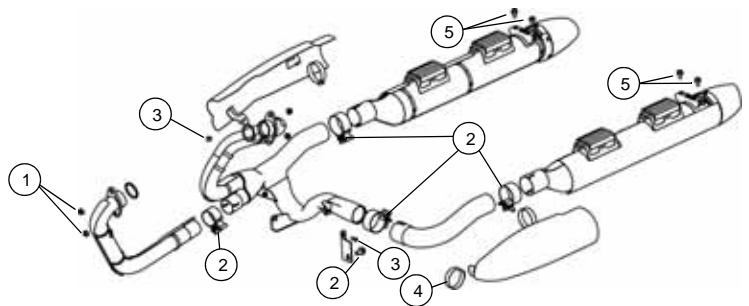

# Maintenance

## Elevating the Motorcycle

**WARNING!** Serious injury or death can occur if the motorcycle tips or falls. Make sure the motorcycle will not tip or fall while elevated or while on the sidestand.

Some procedures require raising the motorcycle to remove weight from the component being inspected. Elevate the motorcycle by placing a stable, flat platform jack or lift mechanism on a firm, flat surface and lifting under the engine crankcase. The platform should be a minimum of 12 inches (30 cm) square. **DO NOT** attempt to lift the motorcycle without proper equipment. Always secure the motorcycle properly before lifting so it cannot tip or fall when elevated.

## Road Test

Before returning the motorcycle to regular use, perform a road test in a safe area. Pay special attention to the proper fit and operation of all serviced components.

Make any corrections or additional adjustments promptly to ensure safe, reliable and enjoyable vehicle performance.

## Fastener Torque

Refer to the service manual or an authorized VICTORY dealer for procedures and fastener torques not listed in this manual.

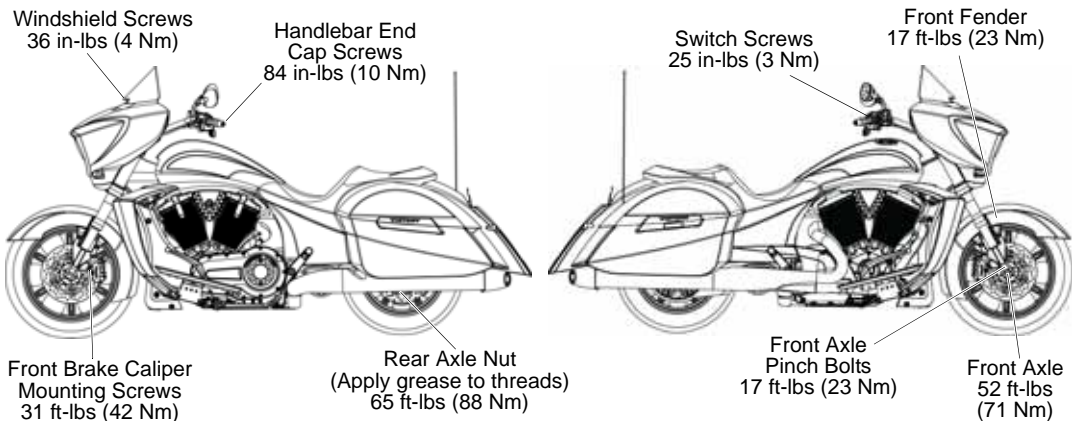

## Troubleshooting

For your personal safety, do not attempt inspection or repairs not fully described in this rider's manual. Contact an authorized VICTORY dealer for service if you cannot determine the cause of a problem or if the inspection / repair exceeds your mechanical ability or tool resources. Do not perform any inspection or repair with the engine running.

### Engine Cranks But Will Not Start

Possible Cause	Possible Remedy/Action
Low Fuel	Verify fuel level
Fuel pump inoperative	Turn engine STOP switch to RUN. Turn key ON. The fuel pump should run momentarily and then stop. If you do not hear the fuel pump run, check the fuel pump / ignition circuit breaker. See page 80. <i>A momentary clicking sound from the IAC valve is normal when the key is first turned to the OFF position.</i>
Battery Discharged	Fully charge the battery. See page 76.
Spark Plug(s) Fouled	Inspect spark plugs. See page 74.
Spark Plug Wire(s) Disconnected or Loose	Be sure spark plug wires are securely fastened.

### Starter Motor Does Not Turn or Turns Slowly

Possible Cause	Possible Remedy/Action
Engine Stop / Run Switch in Stop Position	Place switch in RUN position.
Battery Discharged	Fully charge the battery. See page 76.
Battery Cables Loose or Corroded	Inspect battery cables.
Transmission In Gear	Shift transmission into neutral or pull the clutch lever in to disengage the clutch. See starting procedures on page 46.

### Engine Starts But Misses or Runs Poorly

**Tip:** Turn engine OFF before inspecting any of these items.

Possible Cause	Possible Remedy/Action
Battery Discharged	Fully charge the battery. See page 76.
Battery Cables Loose or Corroded	Inspect battery cables and connections.
Spark Plug(s) Fouled	Inspect spark plugs. See page 74.
Spark Plug Wire(s) Loose or Wet	Inspect spark plug wires, ensure dry/secure.
Contaminated Fuel	Inspect fuel for water / contamination. See dealer.
Engine Oil Level Incorrect Or Wrong Type	Inspect level and quality of oil. See page 38.
Loose, Broken, Shorted Ignition Coil Wires	Inspect coil primary wires. See dealer.
Air Intake Restricted	Inspect air filter. See page 58.

# Maintenance Troubleshooting

## Shifting Difficulties or Hard to Find Neutral

Possible Cause	Possible Remedy/Action
Shift Linkage Bushings Dry Or Worn	Lubricate shift linkage.
Engine Oil Level Incorrect Or Wrong Type	Inspect level and quality of oil. See page 38.
Clutch Damage	Replace clutch.

## Battery Charging Rate Low or Battery Discharges

Possible Cause	Possible Remedy/Action
Loose/Corroded Charging Circuit Connection	Check/clean battery cable connections. Check/clean charging circuit connections. See dealer.
Accessory Load Exceeds Charge Rate	Limit accessory operation when the engine is off.
Improperly Wired Accessory (Current Draw)	See dealer to check charging system output and current draw.
Battery discharges when motorcycle not in use.	See dealer to check key OFF current draw.

## Brake Noise / Poor Brake Performance

**Tip:** Contact a VICTORY dealer if brake performance does not return after these inspections.

Possible Cause	Possible Remedy/Action
Dust / Dirt On Brake Disc(s)	Clean disc. See page 72.
Worn Pads Or Disc / Brake Disc Damage	Inspect pads. See pages 41 and 72.
Brake Fluid Level Low Or Fluid Contaminated	Inspect fluid level / fluid. See pages 39 and 40.

## Service Manual Availability

Some procedures are beyond the scope of this manual. See your dealer to purchase a VICTORY Service Manual for your motorcycle.

Some procedures provided in the Service Manual require specialized knowledge, equipment, and training. Be sure you have the required technical skills and tools that are needed before you attempt ANY service on your motorcycle. Please contact your VICTORY dealer before attempting any service work that is beyond your level of technical knowledge or experience, or if the work requires specialized equipment.



## VICTORY Cleaning Products

This section provides tips on the very best way to clean, polish and preserve every surface of your beautiful new VICTORY Motorcycle. We recommend the use of our new Pure VICTORY cleaning and polishing products and accessories, which have been specially designed to offer the best care possible for your VICTORY motorcycle.

In addition to the products recommended in this section for cleaning and polishing, Pure VICTORY Polishes also has specialty products for:

- removing scratches, scuffs and swirls
- enhancing black and silver engines
- cleaning engines, tires and wheels
- removing brake dust

After cleaning the motorcycle, inspect for damage to the painted surfaces. Repair chips or scratches promptly by applying VICTORY touch-up paint to prevent corrosion. For more information, or for answers to your cleaning and detailing questions, see your VICTORY dealer or write to the Pure VICTORY Polishes Staff at: [victorymailbag@polarisind.com](mailto:victorymailbag@polarisind.com).

## Washing the Motorcycle

**NOTICE:** Do not use pressurized water to wash the motorcycle. Water may seep in and deteriorate wheel bearings, brake caliper assemblies, brake master cylinders, electrical connectors, steering head bearings, and transmission seals. Do not direct any water stream at air intakes, exhaust outlets or electrical connectors.

Electrical components may be damaged by water. Do not allow water to contact electrical components or connectors.

Do not use glass cleaners, water or soil repellents, and petroleum or alcohol based cleaners on the windshield, as these products can damage the windshield.

1. Before washing, make sure exhaust pipes are cool. Cover each pipe opening with a plastic bag secured with a strong rubber band. Check that the spark plugs, spark plug wire caps, oil fill cap and fuel caps are properly seated.
2. Rinse off as much dirt and mud as possible with water running at low pressure. Use as little water as possible when washing near the air cleaner or the exhaust pipe openings. Dry these components thoroughly before using the motorcycle.
3. Clean the front fork tubes thoroughly to reduce fork seal wear and leakage.
4. After washing, remove the rubber bands and plastic bags from the exhaust pipes. Start the engine and let it idle for a few minutes. Make sure the brakes are functioning properly before riding.

# Cleaning and Storage

## Washing the Motorcycle

There are two totally different styles of motorcycle washing and there is a Pure VICTORY Polish product for each style.

### Standard “Bucket Wash”

This is the conventional way to wash your motorcycle. We recommend the use of Pure VICTORY Bike Wash Concentrate, a concentrated gentle product formulated to clean without diminishing the life of any durable polish. This product does not contain alkalis, acids or abrasives and is formulated to perform as a wetting agent to soften bugs, road grime and soil, and to prevent abrasion from your wash mitt or cloth. This product also decreases drying time without spotting or streaking.

1. Add 1 ounce (about 2 capfuls) to 1 gallon of water.
2. Apply to a cool motorcycle with a wool or microfiber wash mitt.

**Tip:** For best results, work one side of the motorcycle at a time, working from top to bottom.

3. Rinse thoroughly with an open hose, no pressure needed. Create a sheeting action to eliminate spotting.
4. Use a Pure VICTORY Microfiber Chamois or Plush Microfiber Towel to dry virtually spot-free.

### Spray-Rinse-and-Ride Wash

This is the new way to clean your VICTORY quickly and easily, then resume riding. Pure VICTORY Spray Rinse and Ride bike wash is safe and will not harm any surface that water won't harm.

If you clean your bike frequently, you may mix this product 50/50 with water. Spray the product on surfaces cool to the touch. **DO NOT** spray on a hot motorcycle. When applied, this product softens dirt, soil, bugs and road grime.

1. Spray windshields, body panels, saddle bags, trunks, engines, tires, wheels, pipes and chrome. Consistent and complete coverage of the motorcycle is important for best results.

**Tip:** Use a cloth or wash mitt on stubborn areas.

2. **DO NOT** allow the product to dry on your motorcycle. Blast rinse with a garden hose equipped with a pressure nozzle. Be sure to rinse thoroughly, then use a gentle rinse to create sheeting action of the water to lessen the possibility of spotting. Use a Pure VICTORY Microfiber Chamois or Plush Microfiber Towel to dry virtually spot-free.

## Washing the Motorcycle

### Quick Clean-Ups

For quick clean-ups between washings, or when water is not available, use Pure VICTORY Spray & Wipe Instant Detailer, a complete spray-and-wipe product designed to clean and polish all surfaces. It works quickly and easily and is silicone-free so it leaves no oily nor white residue. It provides protection from UV rays, acid rain, and dirt. It will remove bugs, road tar, and road grime from your windshield, paint and chrome. This product is safe for all surfaces, including pin striping, custom paint or murals. It's safe for Plexiglas, Lexan, Acrylic or factory-coated windscreens. It's non-streaking, and it provides polish protection and a water-repellent shine.

1. Spray on all surfaces, including the windshield, paint, chrome, wheels and leather to clean, polish and protect.
2. Wipe dry with Pure VICTORY Plush Microfiber Towel. **DO NOT** use a T-shirt.
3. Spray on and wipe off to easily remove bugs, dust and water spots. For heavily soiled surfaces, use product more liberally.

**Tip:** Use this product on the windshield to repel water and enhance rain visibility.

## Polishing the Motorcycle

### Polished Aluminum Care

When a VICTORY is new, the polished aluminum wheels, hand levers and shifter shine like chrome. Ultraviolet (UV) rays and oxidation will cause polished aluminum to grow dull, however, if it's not properly polished and protected.

Pure VICTORY Awesome Metal Polish will clean, polish and protect these aluminum surfaces. This metal polish will restore that factory chrome-like shine and leave a protective coating that resists future oxidation for several months. Pure VICTORY Awesome Metal Polish provides instant results you must see to believe!

1. Shake the polish container well before using.
2. Apply the product with a terry cotton or microfiber cloth or pad.
3. Rub gently until the black begins to come to the surface or until shine begins to show through the haze.
4. Allow the product to haze.
5. Remove the haze with a terry cotton or microfiber cloth and buff to a long-lasting chrome-like shine.

# Cleaning and Storage

## Polishing the Motorcycle

There are now two totally different styles of polishing or protecting your paint and chrome.

### Standard Method of Polishing Paint and Chrome

Pure VICTORY Windshield, Paint and Chrome Polish is a unique formula designed to produce a glass-like shine on painted or clear-coated finishes and chrome surfaces.

- Use it on chrome-plated accessories to prevent surface rust and create a glass-like shine.
- This product creates a high reflective index point, giving a deep, shiny finish without silicone.
- Use it to polish and fill light scratches on Plexiglas, Lexan, Acrylic and factory-coated windshields.
- It repels water from windshields and keeps bugs from sticking.
- Windshield, Paint and Chrome Polish provides long-lasting protection from oxidation, corrosion, UV rays and heat.

### Standard Method of Polishing Paint and Chrome

1. Shake the container well before using.
2. Apply with Pure VICTORY 100% Microfiber Wax Applicator in a circular motion or straight line to a clean surface. It can be applied in direct sunlight.
3. Rub the product until it is almost clear, then allow to dry to a haze before removal. The entire motorcycle can be treated before removing polish.
4. Use a Pure VICTORY Polishes Plush Microfiber Towel to wipe it off easily and dust-free.
5. For best results on a windshield, apply to a clean windshield. Once applied, rain water beads and blows off, enhancing rain visibility. The glass-like finish keeps bugs from sticking and permits their easy removal.

## Polishing the Motorcycle

### Premium Polishing for Long-Lasting Protection

This newer style of polishing paint and chrome utilizes the latest in high-quality polymer technology that provides the longest-lasting protection available in the polish industry today. Pure VICTORY Liquid Spray Wax for Windshields, Paint & Chrome is formulated for polishing after washing and can be sprayed on wet or dry surfaces. Liquid Spray Wax quickly produces a durable, high-gloss shine with minimal effort. It contains NO ABRASIVES and is clear coat-safe. It contains NO PETROLIUM DISTILLATES or SILICONES.

1. Shake container well before use.
2. Begin by washing and rinsing the motorcycle.
3. Spray Liquid Spray Wax on a wet or dry bike, one section at a time. (For best results, the bike's surface should be cool.)
4. Wipe dry one section at a time with Pure VICTORY Microfiber Chamois or microfiber towel.
5. When finished drying, buff the entire motorcycle with a clean, dry Pure VICTORY Microfiber Polishing Towel for a clean and luxurious shine.

**Tip:** Liquid Spray Wax can also be applied to clean and dry clear coats, windshields and chrome. Apply to one section at a time and wipe dry. When finished, use a second towel to buff to a luxurious, long-lasting shine.

## Leather, Rubber and Vinyl Care

### WARNING

Never use a non-recommended protectant on seats, footrests, hand grips or tires. Slippery seats, footrests or hand grips can cause loss of control. Slippery tires can cause loss of traction and loss of control. Both situations could result in serious injury or death.

For the finest leather care, use Pure VICTORY Leather, Vinyl & Rubber Conditioner, a unique, pleasantly scented formula of premium-quality polymers designed to restore luster and softness to vinyl, leather and rubber *without making them slippery*.

This product is a true conditioner, not a coating. It does not close the pores of the surfaces but penetrates, nourishes and softens the material. It protects against ultra violet (UV) rays and cracking, repels water and prolongs the life and like-new appearance of the materials. Applied to rubber, this product creates a water-repellent, like-new appearance. This product can also be used to restore or maintain the factory finish on a VICTORY instrument panel/dash and rear storage compartment black vinyl surfaces. Regular use increases soil resistance.

1. Apply the product on a clean dry surface using a soft cloth.
2. Rub the product into the material. Repeat the treatment if the surface is extremely dry.
3. Wipe dry with a second cloth to remove excess product. Buff lightly with the second towel for additional luster.

## **Cleaning and Storage**

If you will not operate the motorcycle for several months, such as during the winter, store the motorcycle to prevent damage to the fuel system and the battery and to protect components from corrosion or deterioration. During storage you might use products that are potentially hazardous; such as fuel stabilizer. When using any of these products, follow the instructions and warnings on the product packaging.

This section includes instructions for preparing the motorcycle for storage, maintaining it during storage and removing it from storage.

### **Storage Area Preparation**

Choose a dry, well-ventilated storage location, inside a garage or other structure if possible. The location should have a firm, flat surface and allow enough space for the motorcycle.

To best preserve tire condition:

- The storage area should have a relatively constant and moderate temperature.
- The storage surface should be free of oil and gasoline.
- The motorcycle should not be near a radiator or other heat source, or any type of electric motor.

### **Clean and Protect the Motorcycle**

To prepare the motorcycle for storage, begin by cleaning it as outlined beginning on page 85. Wax painted surfaces and polish chromed and other metal surfaces. Apply protectant to exposed rubber, vinyl, and plastic parts.

Do not apply rubber protectant to the tire tread surfaces.

### **Fuel Stabilizer**

Using a mixture of fuel and the recommended amount of VICTORY Premium Carbon Clean Plus or other gasoline stabilizer, fill the fuel tank only to the top of the filler insert.

Ride the motorcycle or start and run the engine for 15 minutes in a well ventilated area to pass the stabilized fuel through entire fuel-injection system.

### **Tire Inflation**

Inflate the tires to normal pressure. See page 74.

## Engine Protection

Change the engine oil. See page 57. Carbon deposits and combustion acids, normally suspended in the engine oil when in service, settle on internal engine components during storage. Settled deposits can cause engine damage or internal corrosion.

## Battery Care

1. Remove the battery. See page 75.
2. Clean the battery terminals first with a wire brush to remove any loose deposits.
3. Wash the posts and the ends of the battery cables with a solution of 1 part baking soda to 16 parts water. Rinse with clean water and wipe dry.
4. Apply a thin film of dielectric grease (available from your VICTORY dealer) to the posts and cable connectors.
5. Clean the outside of the battery with a solution of mild detergent and warm water.
6. Store the battery in a dry area with a temperature of 32° to 90° F (0° to 32° C).
7. While in storage, fully charge the battery once a month. See page 76.

## Park and Cover the Motorcycle

Park the motorcycle in its storage location. Cover it with a genuine VICTORY motorcycle cover, or a cover made from a durable, breathable material designed for storage. Covering the motorcycle helps protect it from dust and other airborne materials. The cover must be of a breathable material to prevent moisture from building up on the motorcycle which can cause oxidation of metal surfaces.

## Rodents

Mice and other rodents are often the worst enemy of a stored motorcycle. If the motorcycle will be stored in an area where mice are a concern (particularly in rural areas, barns, sheds, etc.) be sure to take extra measures to deter their infestation. This may include placing a screen mesh over any intake or exhaust openings (just be sure to remember to remove them when you take the motorcycle from storage).

## Maintenance During Storage

During extended storage periods, maintain tire pressure and battery voltage at the recommended levels.

# Cleaning and Storage

## Removal From Storage

1. Remove the cover and unlock the front forks (if locked).
2. Verify that tire pressure is at specification.
3. Install the battery and perform an electrical inspection.
4. Check the oil level. If the motorcycle was stored in an area subject to wide swings in temperature and humidity (such as outdoors), change the engine oil before starting the engine.

**NOTICE:** During storage, temperature and humidity changes can cause condensation to form in the crankcase and mix with engine oil. Running the engine with oil that contains condensation can cause engine damage.

5. Inspect the storage area for signs of fluid leaks. Identify and perform service to any leaking components.
6. Install new spark plugs if necessary.
7. Wash and polish the motorcycle. Wax, polish, or apply protectant to appropriate components.
8. Perform the pre-ride inspections. See page 36.
9. Perform a road test. See page 82.



## Motorcycle Noise Regulation

Tampering with noise control systems is prohibited. Federal law prohibits the following acts or causing thereof:

- The removal or rendering inoperative by any person other than for the purposes of maintenance, repair, or replacement, of any device or element of design incorporated into any new vehicle for the purpose of noise control prior to its sale or delivery to the ultimate purchaser or while it is in use, or
- The use of the vehicle after such device or element of design has been removed or rendered inoperative by any person.

Among those acts presumed to constitute tampering are:

- Removal or puncturing of the muffler, baffles, header pipes, or any other component which conducts exhaust gasses.
- Removal or puncturing of any part of the intake system.
- Lack of proper maintenance.
- Replacing any moving part of the vehicle, or parts of the exhaust system or intake system, with parts other than those specified by the manufacturer.

This product should be checked for repair or replacement if the motorcycle noise has increased significantly through use. Otherwise, the owner may become subject to penalties under state and local ordinances.

## Noise Emission Warranty

VICTORY Motorcycle Division warrants that this exhaust system, at the time of sale, meets all applicable U.S. EPA Federal noise standards. This warranty extends to the first person who buys this exhaust system for purposes other than resale, and to all subsequent buyers.

Warranty claims should be directed to:

- An authorized VICTORY dealer, or
- VICTORY Motorcycle Division, Polaris Sales Inc., P.O. Box 47700, Hamel, MN 55340-9960

## Emissions Control System Warranty

VICTORY MOTORCYCLES, Polaris Sales Inc. - Emission Control System Warranty Statement

### Your Warranty Rights and Obligations

The California Air Resources Board and VICTORY Motorcycle Division, Polaris Sales Inc. (hereinafter VICTORY) are pleased to explain the emission control system warranty on your 2007 or later VICTORY motorcycle. In California, new motor vehicles must be designed, built and equipped to meet the state's stringent anti-smog standards. VICTORY must warrant the emission control system on your motorcycle for the periods of time listed below provided there has been no abuse, neglect or improper maintenance of your motorcycle. Your emission control system may include parts such as the fuel-injection system, the ignition system, catalytic converter and engine computer. Also included may be hoses, belts, connectors and other emission-related assemblies. Where a warrantable condition exists, VICTORY will repair your motorcycle at no cost to you, including diagnosis, parts and labor.

### Manufacturer's Warranty Coverage

Class III motorcycles (280 cc and larger): for a period of use of five (5) years or 30,000 kilometers (18,641 miles), whichever first occurs.

If an emission-related part on your motorcycle is defective, the part will be repaired or replaced by VICTORY. This is your emission control system DEFECTS WARRANTY.

### Owner's Warranty Responsibilities

As the motorcycle owner, you are responsible for the performance of the required maintenance listed in your Rider's manual. VICTORY recommends that you retain all receipts covering maintenance on your motorcycle, but VICTORY cannot deny warranty solely for the lack of receipts or for your failure to ensure the performance of all scheduled maintenance. You are responsible for presenting your motorcycle to a VICTORY dealer as soon as a problem exists. The warranty repairs should be completed in a reasonable amount of time, not to exceed 30 days. As the motorcycle owner, you should be aware that VICTORY may deny your warranty coverage if your motorcycle or part has failed due to abuse, neglect, improper maintenance or unapproved modifications.

If you have any questions regarding your warranty rights and responsibilities, you should contact VICTORY Motorcycle Division, Polaris Sales Inc., P.O. Box 47700, Hamel, Minnesota 55340-9960, or the California Air Resources Board, P.O. Box 8001, 9528 Telstar Avenue, El Monte, CA 91734-8001.

# Warranty

## Emissions Control System Warranty

### VICTORY Motorcycle Division, Polaris Sales Inc. - Limited Warranty on Emission Control System

VICTORY Motorcycle Division, Polaris Sales Inc., (hereinafter VICTORY) warrants that each new 2009 and later VICTORY Motorcycle that includes as standard equipment a headlight, taillight and stoplight, and is street legal:

A. is designed, built and equipped so as to conform at the time of initial retail purchases with all applicable regulations of the United States Environmental Protection Agency, and the California Air Resources Board; and

B. is free from defects in material and workmanship which cause such motorcycle to fail to conform with applicable regulations of the United States Environmental Protection Agency or the California Air Resources Board for a period of use, depending on the engine displacement, of 12,000 kilometers (7,456 miles), if the motorcycle's engine displacement is less than 170 cubic centimeters; of 18,000 kilometers (11,185 miles), if the motorcycle's engine displacement is equal or greater than 170 cubic centimeters but less than 280 cubic centimeters; or of 30,000 kilometers (18,641 miles), if the motorcycle's engine displacement is 280 cubic centimeters or greater; or 5 (five) years from the date of initial retail delivery, whichever occurs first.

### I. Coverage

Warranty defects shall be remedied during customary business hours at any authorized VICTORY motorcycle dealer located within the United States of America in compliance with the Clean Air Act and applicable regulations of the United States Environmental Protection Agency and the California Air Resources Board. Any part or parts replaced under this warranty shall become the property of VICTORY.

In the State of California only, emission related warranted parts are specifically defined by the state's Emission Warranty Parts List. These warranted parts are: carburetor and internal parts; intake manifold; fuel tank; fuel injection system; spark advance mechanism; crankcase breather; air cutoff valves; fuel tank cap for evaporative emission controlled vehicles; oil filler cap; pressure control valve; fuel/vapor separator; canister; igniters; breaker governors; ignition coils; ignition wires; ignition points; condensers, and spark plugs if failure occurs prior to the first scheduled replacement; and hoses, clamps, fittings and tubing used directly in these parts. Since emission related parts may vary from model to model, certain models may not contain all of these parts and certain models may contain functionally equivalent parts.

In the State of California only, Emission Control System emergency repairs, as provided for in the California Administrative Code, may be performed by other than an authorized VICTORY dealer. An emergency situation occurs when an authorized VICTORY dealer is not reasonably available, a part is not available within 30 days, or a repair is not complete within 30 days. Any replacement part can be used in an emergency repair. VICTORY will reimburse the owner for expenses, including diagnosis, not to exceed VICTORY's suggested retail price for all warranted parts replaced and labor charges based on VICTORY's recommended time allowance for the warranty repair and the geographically appropriate hourly labor rate. The owner may be required to keep receipts and failed parts in order to receive compensation.

### II. Limitations

The Emission Control System Warranty shall not cover any of the following:

A. Repair or replacement required as a result of:

- Accident
- Misuse
- Repairs improperly performed or replacements improperly installed
- Use of replacement parts or accessories not conforming to VICTORY specifications which adversely affect performance and/or
- Use in competitive racing or related events.

B. Inspections, replacement of parts, and other services and adjustments necessary for required maintenance

C. Any motorcycle on which the odometer mileage has been changed so that actual mileage cannot be readily determined.

## Emissions Control System Warranty

### III. Limited Liability

A. The liability of VICTORY under this Emission Control System Warranty is limited solely to the remedying of defects in material or workmanship by an authorized VICTORY motorcycle dealer at its place of business during customary business hours. This warranty does not cover inconvenience or loss of use of the motorcycle or transportation of the motorcycle to or from the VICTORY dealer. VICTORY SHALL NOT BE LIABLE FOR ANY OTHER EXPENSES, LOSS OR DAMAGE, WHETHER DIRECT, INCIDENTAL, CONSEQUENTIAL OR EXEMPLARY ARISING IN CONNECTION WITH THE SALE OR USE OF OR INABILITY TO USE THE VICTORY MOTORCYCLE FOR ANY PURPOSE. SOME STATES DO NOT ALLOW THE EXCLUSION OR LIMITATION OF ANY INCIDENTAL OR CONSEQUENTIAL DAMAGES, SO THE ABOVE LIMITATIONS MAY NOT APPLY TO YOU.

B. NO EXPRESS EMISSION CONTROL SYSTEM WARRANTY IS GIVEN BY VICTORY EXCEPT AS SPECIFICALLY SET FORTH HEREIN. ANY EMISSION CONTROL SYSTEM WARRANTY IMPLIED BY LAW, INCLUDING ANY WARRANTY OF MERCHANTABILITY OR FITNESS FOR A PARTICULAR PURPOSE, IS LIMITED TO THE EXPRESS EMISSION CONTROL SYSTEM WARRANTY TERMS STATED IN THIS WARRANTY. THE FOREGOING STATEMENTS OF WARRANTY ARE EXCLUSIVE AND IN LIEU OF ALL OTHER REMEDIES. SOME STATES DO NOT ALLOW LIMITATIONS ON HOW LONG AN IMPLIED WARRANTY LASTS SO THE ABOVE LIMITATIONS MAY NOT APPLY TO YOU.

C. No dealer is authorized to modify this VICTORY Limited Emission Control System Warranty.

### IV. Legal Rights

THIS WARRANTY GIVES YOU SPECIFIC LEGAL RIGHTS, AND YOU MAY ALSO HAVE OTHER RIGHTS WHICH VARY FROM STATE TO STATE.

### V. This warranty is in addition to the VICTORY Limited Motorcycle Warranty

### VI. Additional Information

Any replacement part that is equivalent in performance and durability may be used in the performance of any maintenance or repairs. However, VICTORY is not liable for these parts. The owner is responsible for the performance of all required maintenance. Such maintenance may be performed at a service establishment or by any individual. The warranty period begins on the date the motorcycle is delivered to an ultimate purchaser.

**VICTORY Motorcycle Division, Polaris Sales, Inc.**  
**P.O. Box 47700**  
**Hamel, MN 55340-9960**  
**ATTN: Warranty Department**

# Warranty

## VICTORY Motorcycle Warranty Policy

### Limited Warranty

VICTORY Motorcycle Division, Polaris Sales Inc., P.O. Box 47700, Hamel, Minnesota 55340-9960, gives a ONE YEAR LIMITED WARRANTY on all components of the VICTORY Motorcycle against defects in material or workmanship. This warranty covers the parts and labor charges for repair or replacement of defective parts which are covered by this warranty. This warranty begins on the date of purchase. This warranty is transferable to another consumer during the warranty period through a VICTORY Motorcycle dealer.

### Registration

At the time of sale, the Warranty Registration Form must be completed by your dealer and submitted to VICTORY Motorcycle Division, Polaris Sales Inc. within ten days. Upon receipt of this registration, VICTORY Motorcycle Division, Polaris Sales Inc. will record the registration for warranty. No verification of registration will be sent to the purchaser as the copy of the Warranty Registration Form will be the warranty entitlement. If you have not signed the original registration and received the "customer copy", please contact your dealer immediately. NO WARRANTY COVERAGE WILL BE ALLOWED UNLESS YOUR VICTORY MOTORCYCLE IS REGISTERED WITH VICTORY MOTORCYCLES DIVISION OF POLARIS SALES INC.

Initial dealer preparation and set-up of your VICTORY Motorcycle is very important in ensuring trouble-free operation. Purchasing a motorcycle in the crate or without proper dealer set-up will void your warranty coverage.

### Warranty Coverage and Exclusions:

#### Limitations of Warranties and Remedies

The warranty excludes any failures that are not caused by a defect in material or workmanship. This warranty does not cover accidental damage, normal wear and tear, abuse or improper handling. This warranty also does not cover any VICTORY Motorcycle that has been altered structurally, modified, neglected, improperly maintained, used for racing, or used for purposes other than for which it was manufactured, or for any damages which occur during trailer transit or as a result of unauthorized service or the use of unauthorized parts. In addition, this warranty does not cover physical damage to paint or finish, stress cracks, tearing or puncturing of upholstery material, corrosion, or defects in parts, components or VICTORY Motorcycle due to fire, explosions or any other cause beyond VICTORY Motorcycle Division, Polaris Sales Inc. control.

This warranty does not cover the use of unauthorized lubricants, chemicals, or fuels that are not compatible with the VICTORY Motorcycle.

The exclusive remedy for breach of this warranty shall be, at VICTORY Motorcycle Division, Polaris Sales Inc. exclusive option, repair or replacement of any defective materials, or components or products. THE REMEDIES SET FORTH IN THIS WARRANTY ARE THE ONLY REMEDIES AVAILABLE TO ANY PERSON FOR BREACH OF THIS WARRANTY. VICTORY MOTORCYCLES DIVISION OF POLARIS SALES INC. SHALL HAVE NO LIABILITY TO ANY PERSON FOR INCIDENTAL, CONSEQUENTIAL OR SPECIAL DAMAGES OF ANY DESCRIPTION, WHETHER ARISING OUT OF EXPRESS OR IMPLIED WARRANTY OR ANY OTHER CONTRACT, NEGLIGENCE, OR OTHER TORT OR OTHERWISE. THIS EXCLUSION OF CONSEQUENTIAL, INCIDENTAL, AND SPECIAL DAMAGES IS INDEPENDENT FROM AND SHALL SURVIVE ANY FINDING THAT THE EXCLUSIVE REMEDY FAILED OF ITS ESSENTIAL PURPOSE. Some states do not permit the exclusion or limitation of incidental or consequential damages or implied warranties, so the above limitations or exclusions may not apply to you if inconsistent with controlling state law.

#### Limitations of Warranties and Remedies

ALL IMPLIED WARRANTIES (INCLUDING BUT NOT LIMITED TO THE IMPLIED WARRANTIES OF MERCHANTABILITY AND FITNESS FOR A PARTICULAR PURPOSE) ARE LIMITED IN DURATION TO THE ABOVE ONE YEAR WARRANTY PERIOD. VICTORY MOTORCYCLES DIVISION OF POLARIS SALES INC. FURTHER DISCLAIMS ALL EXPRESS WARRANTIES NOT STATED IN THIS WARRANTY OTHER THAN EMISSIONS AND EXCISE WARRANTIES. Some states do not allow limitations on how long an implied warranty lasts, so the above limitation may not apply to you if inconsistent with controlling state law.

### How To Obtain Warranty Service

If your VICTORY Motorcycle requires warranty service, you must take it to a VICTORY Motorcycle Servicing Dealer. When requesting warranty service you must present your copy of the Warranty Registration form to the dealer. (THE COST OF TRANSPORTATION TO AND FROM THE DEALER IS YOUR RESPONSIBILITY). VICTORY MOTORCYCLES division of Polaris Sales Inc. suggests that you use your original selling dealer; however, you may use any VICTORY Motorcycle Servicing Dealer to perform warranty service.

Please work with your dealer to resolve any warranty issues. Should your dealer require any additional assistance they will contact the appropriate person at VICTORY MOTORCYCLES division of Polaris Sales Inc.

This warranty also gives you specific legal rights, and you may also have other rights which vary from state to state.

If any of the above terms are void because of state or federal law, all other warranty terms will remain in effect.

# Specifications

	CROSS ROADS	CROSS COUNTRY
<b>Dimensions</b> (Dimensions and specifications may vary with features, options and accessories)		
Overall Length	104.4 in. (265 cm)	104.4 in. (265 cm) 108.2 in. (274.8 cm) w/Trunk
Overall Width	36 in. (91.4 cm)	39.2 in. (99.5 cm)
Overall Height	56.3 in. (143 cm)	53.2 in. (135.1 cm)
Seat Height	26.3 in. (66.8 cm)	26.3 in. (66.8 cm)
Wheel Base	65.7 in. (167 cm)	65.7 in. (167 cm)
Ground Clearance	5.8 in. (14.8 cm)	5.8 in. (14.8 cm)
Rake & Trail	29°/5.6 in. (14.2 cm)	29°/5.6 in. (14.2 cm)
<b>Weight</b>		
Dry Weight	745 lbs. (338 kg)	765 lbs. (347 kg) 800 lbs. (363 kg) w/Trunk
Wet Weight	780 lbs. (354 kg)	800 lbs. (363 kg) 835 lbs. (380 kg) w/Trunk
Maximum Load Capacity (riders, cargo, accessories, options)	580 lbs. (263 kg)	560 lbs. (254 kg) 525 lbs. (239 kg) w/Trunk
Gross Vehicle Weight Rating (GVWR) (see page 14)	1360 lbs. (617 kg)	
Gross Axle Weight Rating (GAWR)	Front Axle: 460 lbs. (209 kg) Rear Axle: 900 lbs. (408 kg)	

	CROSS ROADS / CROSS COUNTRY
<b>Capacities</b>	
Engine Oil	5 qt. (4.75 l) Approximately 4.5 qt. (4.25 l) at oil change
Fuel	5.8 gal. (22 l)
Fuel Reserve	1.0 gal. (3.8 l)
<b>Engine</b>	
Engine Type	VICTORY Freedom® 106 / 6 V-Twin
Configuration	50° V-Twin 4 Stroke SOHC
Displacement	106 Cubic Inch (1731 cc)
Cooling System	Air & Oil
Compression Ratio	9.4:1
Valve Train	4 Valves per cylinder, Hydraulic Lifters & Self-Adjusting Cam Chains
Bore & Stroke	101 x 108 mm
Throttle Body Bore	45 mm
Electronic Fuel Injection System	Closed Loop
Lubrication System	Wet Sump
Spark Plug / Gap	NGK DCPR6E / .031-.035 inch (0.8-0.9 mm)
Exhaust	Split dual exhaust with crossover

# Specifications

<b>CROSS ROADS / CROSS COUNTRY</b>	
<b>Chassis</b>	
Front Suspension Type / Travel	Telescopic Fork / 5.1 in. (13 cm)
Front Fork Tube Diameter	43 mm
Rear Suspension Type / Travel	Single Monotube Air Adjustable Shock: 4.7 in. (12 cm)
Swingarm	Cast Aluminum with Constant Rate Linkage
Front Brakes	Dual 300 x 5 mm / Floating Rotor / 4 Piston Calipers
Rear Brakes	Single 300 x 7 mm / Floating Rotor / 2 Piston Caliper
Total Storage Volume	21.3 gallons (80.6 liters)
<b>Drive System</b>	
Final Drive Type	Carbon Fiber Reinforced Belt
Transmission Type	6 Speed Constant Mesh with True Overdrive
Primary Drive Type (Reduction Ratio)	Gear Drive with Torque Compensator (1.49:1)
<b>Drive System</b>	
Gear Shift Pattern	1 Down 5 Up
Internal Gear Ratios	
1st	3.13:1
2nd	2.02:1
3rd	1.50:1
4th	1.20:1
5th	1:1
6th (Overdrive)	.87:1
Final Drive Ratio	2.12:1
Clutch Type	Wet, Multi Plate, Diaphragm Spring
<b>Wheels And Tires</b>	
Front Wheel Type / Size	Cast or Billet 18 x 3.0 inch
Front Tire Type / Size	DUNLOP Elite 3 - 130/70R18 63H Radial
Rear Wheel Type / Size	Cast or Billet 16 x 5.0 inch
Rear Tire Type / Size	DUNLOP Elite 3 - 180/60R16 M/C 80H Radial
<b>Electrical</b>	
Alternator	48 Amp Maximum Output
Battery	12 Volt / 18 Amp Hour / 310 CCA / Yuasa YTX20HL
<b>Lights</b>	
Headlamp (High / Low)	High H11 / Low H11
HID Headlamp (High / Low)	High H11 / Low D1SR
Turn Signal Lamp	Non-Serviceable LED
Tail / Brake / License Plate Lamp	Non-Serviceable LED
<b>Fuses / Circuit Breakers</b>	
Engine	15A
Fuel Pump/Ignition Coil	15A
Lights	20A
Turn Signals/Horn	10A
Ignition	10A
Chassis	20A
Accessory	20A
Radio	25A (CROSS COUNTRY)

## Fuel Recommendation

For best performance, use only unleaded gasoline with a 91 pump octane minimum (R+M/2 Method).

**DO NOT USE E-85 GASOLINE OR GASOLINE CONTAINING METHANOL.** Using E85 or gasoline / methanol blends can result in poor starting and driveability, and may damage critical fuel system components.

Gasoline containing up to 10% Ethanol can be used.

Gasoline containing up to 15% Methyl Tertiary Butyl Ether (MTBE) can be used.

## Engine Oil Recommendation

Polaris Recommends the use of VICTORY brand Semi-Synthetic 20W-40 Motor Oil or equivalent *motorcycle* oil that is approved for use in wet clutch transmissions (such as those with a JASO MA rating).

## Identification Number Record

Record important identification numbers below.	
Vehicle Identification Number (VIN) (see page 15)	
Engine Identification Number (see page 16)	
Ignition Key Number (see page 16)	

# Audio System Overview

## Audio System Introduction

Not all motorcycles are equipped with all components discussed in the audio section of this manual. Components not installed at the factory can be purchased from and installed by your VICTORY dealer.

### Software Updates

Radio system software should be updated annually to ensure the best performance. Please see your authorized VICTORY dealer for this service.

## Radio Frequencies

### North America

- AM 520 to 1720 kHz
- FM 87.9 to 107.9 MHz
- WX 162.40 to 162.55 MHz

### European

- FM 87.5 to 108.00 MHz
- MW 522 to 1602 kHz
- LW 144 to 288 kHz

## Audio Controls

Operation of the audio controls is outlined in greater detail on the following pages.

### U.S.A. Sources

- FM
- AM
- WX
- AUX (NAV MP3, AUX or iPod)
- XM Radio

### European Sources

- FM
- MW
- LW
- AUX (NAV MP3, AUX or iPod)

### Mode Menu Options

- Bass
- Treble
- Fader
- External Speakers
- Automatic Volume Control
- CB Headset ENT Mode
- ICOM Volume
- CB Volume
- CB Local/Distant
- AM/FM Clear Preset
- Radio Data System
- AUX Mode
- XM Clear Preset
- XM Display
- XM Category

## Audio Controls

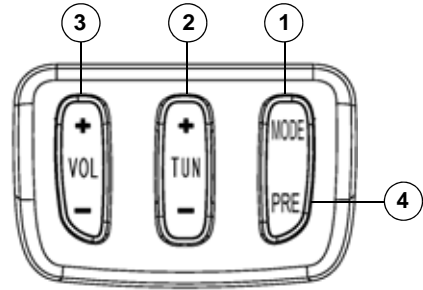

1. **Mode Button:** Press and hold the MODE button until the system enters the audio system mode menus. Then press and release the MODE button until the desired mode menu displays.  
**Tip:** Some mode menu options have sub-menus. Sources and menu options will be displayed only for installed components.
2. **Tuner Button:** Press and release TUNE (+) or TUNE (-) to change radio stations or iPod tracks. Press and hold to automatically seek or scan.
3. **Volume Button:** Press VOL (+) to turn the audio system on. Press VOL (+) to increase audio volume. Press VOL (-) to decrease audio volume. Press and hold to rapidly increase or decrease volume. When volume is decreased until "OFF" displays, continuing to press and hold VOL (-) for two seconds will turn the radio off.
4. **Memory Preset (PRE) Button:** Press PRE to cycle through the stored preset locations. See page 104.



# Audio System Overview

## Citizens Band (CB) Radio Controls

If equipped, the operator's CB radio controls are located on the left handlebar above the audio controls. Operation of these controls is outlined in greater detail on the following pages.

1. **Push-to-Talk (PTT):** Press and hold the top or bottom of the button to transmit. See page 110.
2. **Squelch:** Press SQ (+) or SQ (-) to adjust CB radio channel reception sensitivity. See page 110.
3. **COM:** Press COM to turn the CB radio on or off. Press and hold COM to select a COM channel.
4. **ICOM:** Press ICOM to turn the driver/passenger intercom on or off. Press and hold ICOM to access Voice-Activated Switch (VOX) settings. See page 112.

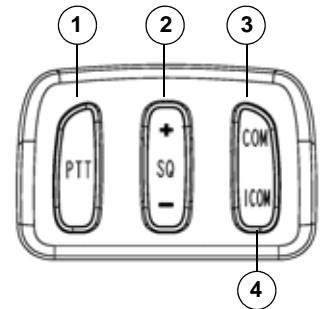

## Passenger CB Controls

The passenger's radio controls are located on the headset cord.

1. **Push-to-Talk (PTT):** Press and hold the button to transmit.
2. **Rear Volume:** Press (+) or (-) to adjust the rear headset volume.

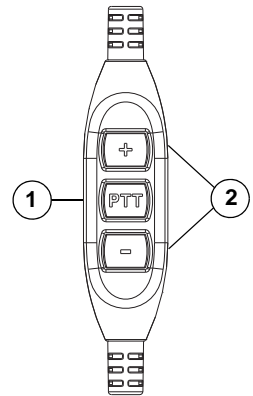

# Audio System Operation

## Audio System Power

The ignition key must be in the ACC or ON position to use the audio system.

With the key in the ACC or ON position and audio system OFF, the screen will display “VICTORY”.



**Tip:** To prevent battery drain, do not leave the key in the ACC position for long periods. VICTORY recommends using the audio system only when the engine is running.

Press VOL (+) to turn the audio system on. The screen will display the active entertainment source.

1. Current audio source:
  - (U.S.) FM / AM / WX / iPod - AUX / XM
  - (Euro) FM / MW / LW / iPod - AUX
2. Station preset number (P1-P15)
3. Stereo indicator
4. Intercom system active (if equipped)
5. CB radio active channel (if equipped)

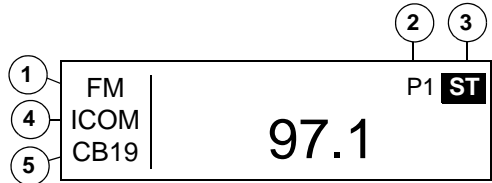

**Tip:** The audio system will always display the last active source when turned on.

## Audio Volume Control

The driver can adjust volume for the speakers and turn the speakers off or on.

### Audio Volume

Press and release VOL (+) or VOL (-) to raise or lower volume.

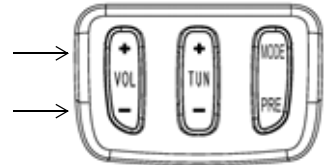

# Audio System Operation

## Selecting Audio Sources

Press and release the MODE button until the desired source is active.

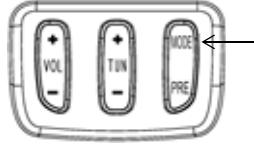

**FM source active:**  
U.S. / European models

FM	97.1	ST
----	------	----

**AM source active:**  
U.S. models only

AM	1130
----	------

**WX (Weather) source active:**  
U.S. models only

WX	3
----	---

**NAV MP3 source active:**  
U.S. / European models

AUX	NAV MP3
-----	---------

**iPod source active:**  
U.S. / European models (skipped if not equipped)

iPod	Artist Title Playlist
------	-----------------------------

**AUX source active:**  
U.S. / European models

AUX	AUX
-----	-----

**XM Radio source active:**  
U.S. models only (skipped if not equipped)

XM	CH25	P6	TheBlend
			Sting Fields of Gold

**MW (Medium Wave) Source:**  
European models only

MW	531
----	-----

**LW (Long Wave) source:**  
European models only

LW	144
----	-----

# Audio System Operation

## Audio Tuning

Use the tuner on the left control to select radio stations.

Press and *release* TUNE (+) or TUNE (-) to locate stations in single-step increments.

Press and *hold* TUNE (+) or TUNE (-) to seek or scan for stations depending on mode setting.

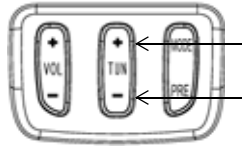

## Memory Presets

The audio system features 15 user-defined presets for storing favorite stations.

1. To set a preset, press and release the MODE button until the desired source is active (FM, AM, WX, XM, MW, LW).

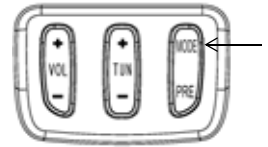

2. Use TUNE or seek/scan to locate a radio station.

3. Press and hold the PRE button.

4. Press TUNE (+) or TUNE (-) to cycle to an available preset location. The preset location displays on the screen.

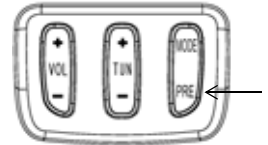

*Station being stored*

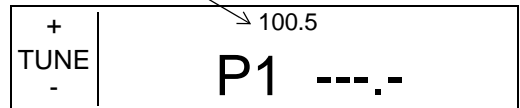

5. When the desired location is displayed, press and hold the PRE button to store the selected radio station.

**Tip:** If the desired preset location already contains a stored radio station, it will be overwritten by the new selection.

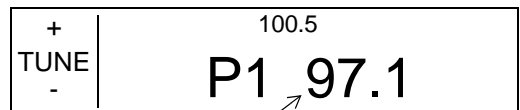

*Station will be overwritten*

6. Wait 5 seconds or push VOL (+) or VOL (-) to exit.
7. To listen to a preset location, press and release the PRE button until the desired location displays.

# Audio System Operation

## Audio Mode Menus

### Entering Mode Menus

Press and hold the MODE button until the system enters the audio system mode menus. Then press and release the MODE button until the desired mode menu displays.

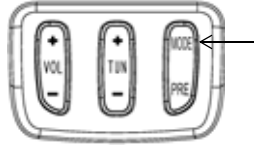

To change mode settings, enter the mode menu. Press TUNE (+) or TUNE (-) to change settings. Wait 5 seconds or push VOL (+) or VOL (-) to exit.

### Exiting Mode Menus

Exit the screen and return to the default display in one of two ways.

1. Wait 5 seconds. The system will automatically exit.
2. Press VOL (+) or VOL (-).

**Tip:** The volume will also change.

### Bass Setting

Press TUNE (+) or TUNE (-) to adjust.

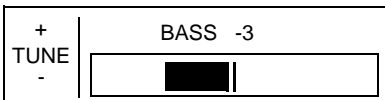
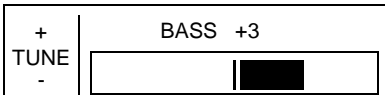
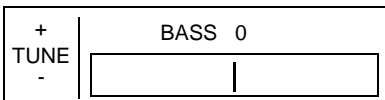

### Treble Setting

Press TUNE (+) or TUNE (-) to adjust.

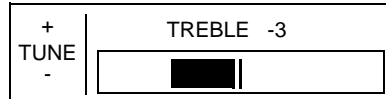
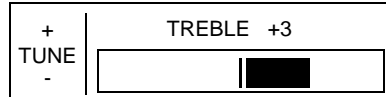
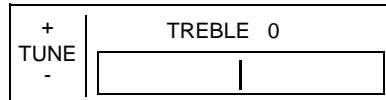

### Fader Setting

Press TUNE (+) or TUNE (-) to adjust.

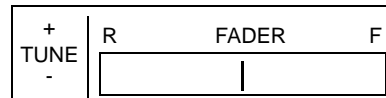

### External Speakers

Press TUNE (+) or TUNE (-) to turn the speakers on or off.



# Audio System Operation

## Audio Mode Menus

To change mode settings, enter the mode menu. Press TUNE (+) or TUNE (-) to change settings. Wait 5 seconds or push VOL (+) or VOL (-) to exit.

### Automatic Volume Control (AVC)

When set, this feature will lower or raise the speaker/headset volume automatically, based on vehicle speed.

Press TUNE (+) or TUNE (-) to change settings.

**Off:** Volume will not adjust

**Low:** Least aggressive setting

**Medium:** Moderate setting

**High:** Most aggressive setting

+ TUNE -	AUTO VOL CONTROL OFF
----------------	-------------------------

+ TUNE -	AUTO VOL CONTROL LOW
----------------	-------------------------

+ TUNE -	AUTO VOL CONTROL MEDIUM
----------------	----------------------------

+ TUNE -	AUTO VOL CONTROL HIGH
----------------	--------------------------

### CB Headset Volume Controls (if equipped)

The headsets have three separate volume settings: Intercom (ICOM) volume, CB receive volume and entertainment (ENT) volume. Always position headsets with the speakers directly over your ears to ensure the best sound quality and volume.

**Tip:** The driver can turn off the external speakers and listen to audio only through the headsets. See page 105.

Volume Adjustments			
Item	Can Be Adjusted	Driver Controls	Passenger Controls
ICOM Volume	When VOX is in use	Press VOL (+) or VOL (-)	Press (+) or (-) on the headset cord control
CB Receive Volume	When receiving a CB transmission		
ENT Volume	While listening to ENT		

### CB Headset ENT Mode (if equipped)

**OFF:** Only communications are audible in the headsets. Riders can listen to navigation commands and entertainment with the external speakers while reserving the headset for communication.

**MIX:** The audio source volume drops lower than the ICOM volume whenever the voice-operated switch (VOX) is opened. The audio source volume gradually returns to its original level after the VOX is closed.

**MUTE:** The audio source volume is muted when the VOX is opened. The audio source volume gradually returns to its original level after the VOX is closed.

+ TUNE -	HEADSET ENT MODE OFF
----------------	-------------------------

+ TUNE -	HEADSET ENT MODE MIX
----------------	-------------------------

+ TUNE -	HEADSET ENT MODE MUTE
----------------	--------------------------

# Audio System Operation

## Audio Mode Menus

To change mode settings, enter the mode menu. Press TUNE (+) or TUNE (-) to change settings.

**Tip:** Sources and menu options will be displayed only for installed components.

### Driver ICOM Volume

Press TUNE (+) or TUNE (-) to adjust.

+ TUNE -	ICOM VOL 15 
----------------	--

### Driver CB Volume

Press TUNE (+) or TUNE (-) to adjust.

+ TUNE -	CB VOL 15 
----------------	--

### CB LO/DX Mode

Press TUNE (+) or TUNE (-) to change settings. See page 111 for more detailed information.

+ TUNE -	CB LO / DX MODE DISTANT
----------------	----------------------------

+ TUNE -	CB LO / DX MODE LOCAL
----------------	--------------------------

## Radio Data System (RDS)

Press TUNE (+) or TUNE (-) to turn the radio data system on or off. When on, the screen will display artist, song title, etc. (if available in the radio signal).

+ TUNE -	RDS OFF
+ TUNE -	RDS ON

## AUX Mode

Press TUNE (+) or TUNE (-) to choose AUX (for iPod or any other MP3 player use) or NAV MP3 (for navigation unit MP3 player use).

**Tip:** NAV MP3 mode will override any device connected with an input cable. If using NAV MP3 mode, always pause the GARMIN unit before changing sources. Otherwise, music from the NAV unit will interrupt the new source, interpreting it as navigation commands, not music.

+ TUNE -	AUX MODE AUX
+ TUNE -	AUX MODE NAV MP3

# Audio System Operation

## Audio Mode Menus

To change mode settings, enter the mode menu. Press TUNE (+) or TUNE (-) to change settings.

**Tip:** Sources and menu options will be displayed only for installed components.

### XM Display

Press TUNE (+) or TUNE (-) to set the screen to display channel name or category when the XM radio is active.

+ TUNE -	XM DISPLAY CHANNEL NAME
+ TUNE -	XM DISPLAY CATEGORY

### XM Category

Press TUNE (+) or TUNE (-) to set the music selection category when tuning XM. These categories are downloaded from XM whenever the XM antenna is receiving a signal and may change from time to time.

**Tip:** Selecting a category will then limit the channels available to those within that category until ALL CHANNELS or another category is selected.

+ TUNE -	XM CATEGORY All Channels
+ TUNE -	XM CATEGORY MorMusic
+ TUNE -	XM CATEGORY Traffic

## Weather Band (WX)

Weather band channels are broadcast by the National Oceanic and Atmospheric Administration (NOAA). NOAA operates more than 940 transmitters covering the United States, Puerto Rico, the U.S. Virgin Islands, the U.S. Pacific Territories and adjacent coastal waterways.

Press and release the MODE button until the desired source is active. When the WX source is selected, a total of 7 weather band channels are available.

Typically, only one weather band channel will be available for a given location. When traveling, if a channel becomes unavailable, search for another active channel.

Press TUNE (+) or TUNE (-) to access a channel.

### WX Channels

WX Ch.	Freq.
1	162.400
2	162.425
3	162.450
4	162.475
5	162.500
6	162.525
7	162.550



# CB Radio / ICOM System

## CB Channels

## CB/ICOM Introduction

In the U.S.A., refer to the Federal Communications Commission (FCC) Plain Rules pamphlet accompanying this rider's manual for a comprehensive guide of citizens band (CB) radio rules and regulations.

## Headset Use

The use of helmet-mounted headsets may be restricted or prohibited in some areas. Always obey all applicable regulations and laws.

The headsets have three separate volume settings: Intercom (ICOM) volume, CB receive volume and entertainment (ENT) volume. See page 106.

## Getting Started

**Tip:** To minimize distractions while riding, always make adjustments to the CB/ICOM system prior to operating your motorcycle.

**Tip:** To prevent battery drain, do not leave the key in the ACC position for long periods. VICTORY recommends using the audio system only when the engine is running.

The ignition key must be in the ACC or ON position to use the audio system.

1. Press VOL (+) to turn the audio system on.
2. Press COM on the left control to activate the CB/COM system.



When the CB radio system is active, "CB" and the active channel will display.



Press and hold COM on the upper left control to access the CHANNEL ADJUST screen.

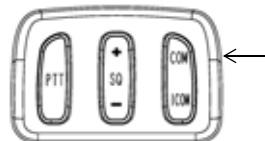

Push COM or ICOM to change channels.



**Tip:** Changing to a new channel may require changing the squelch setting.

Wait 5 seconds or push VOL (+) or VOL (-) to exit the screen and return to the main display.

# CB Radio / ICOM System Push-to-Talk (PTT)

Press and hold the top or bottom of the PTT button to transmit over CB radio. The passenger must push and hold the PTT button on the headset controls.

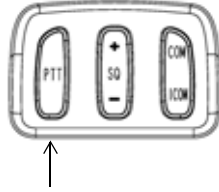

**Tip:** PTT will activate the intercom when the intercom is turned on and the CB is turned off.

“TX” will display on the console screen when one of the PTT buttons is pressed. “RX” will display when the CB is receiving a transmission.

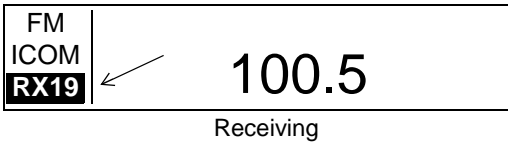
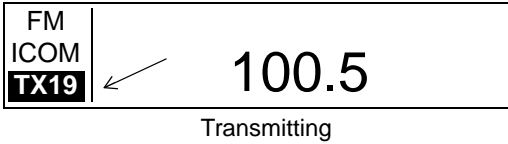

# Squelch

Squelch blocks undesired signals and noise by allowing the reception of signals only over a specified level.

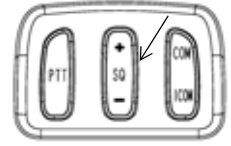

Press and release the SQ (+) or SQ (-) buttons to adjust the squelch to any level between OPEN and CLOSED.

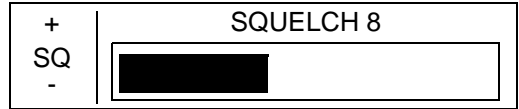

When squelch is set to OPEN, no filtering occurs. Setting squelch to CLOSED blocks all signals, including strong signals.

To set the squelch level, first lower the squelch level until noise or static is audible. Gradually increase the squelch level until the noise or static is gone.

# Driver CB Radio Volume

To change settings, enter the mode menu. Press TUNE (+) or TUNE (-) to adjust settings.

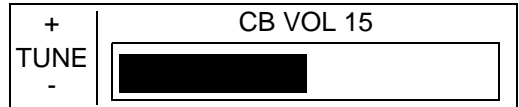

**Tip:** The CB volume can also be set using the hand control when the CB is receiving.

# Passenger CB Radio Volume

The passenger can control rear headset volume when Entertainment, CB radio or ICOM is active.

Press (+) or (-) on the headset control to raise or lower volume.

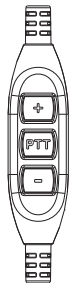

# CB Radio / ICOM System

## Local/Distant CB Radio Mode

To change mode settings, enter the mode menu. Press TUNE (+) or TUNE (-) to set the CB to local (LO) or distant (DX) mode.

**Distant:** Use this setting for weaker signals. Receiver sensitivity will be increased. Static and noise levels are increased.

**Local:** Use this setting for stronger signals or in high density areas. Receiver sensitivity will be decreased. Static and noise levels are decreased.

+	TUNE	CB LO / DX MODE DISTANT
-		

+	TUNE	CB LO / DX MODE LOCAL
-		

## CB Radio Frequencies

The FCC has designated 40 citizen band (CB) channels for consumer use. Channel 9 is designated as an EMERGENCY channel for emergency use only.

### CB Channels / Frequencies

Ch.	Freq.	Ch.	Freq.	Ch.	Freq.	Ch.	Freq.	Ch.	Freq.	Ch.	Freq.
1	26.965	8	27.055	15	27.135	22	27.225	29	27.295	36	27.365
2	26.975	9	27.065	16	27.155	23	27.255	30	27.305	37	27.375
3	26.985	10	27.075	17	27.165	24	27.235	31	27.315	38	27.385
4	27.005	11	27.085	18	27.175	25	27.245	32	27.325	39	27.395
5	27.015	12	27.105	19	27.185	26	27.265	33	27.335	40	27.405
6	27.025	13	27.115	20	27.205	27	27.275	34	27.345		
7	27.035	14	27.125	21	27.125	28	27.285	35	27.355		

# CB Radio / ICOM System

## ICOM System

Press and release ICOM on the left control to activate the intercom system.

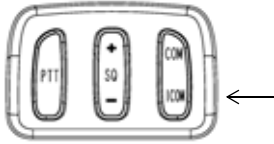

When the intercom system is active, ICOM will display on the console screen.

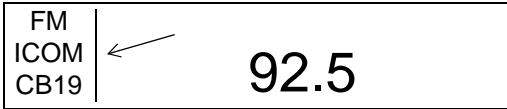

## Driver ICOM Volume

To change settings, enter the mode menu. Press TUNE (+) or TUNE (-) to adjust settings.

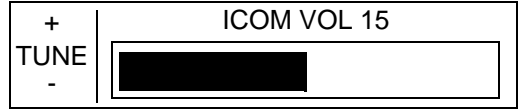

**Tip:** Intercom volume can also be adjusted with the hand control when the VOX circuit is open.

## Passenger ICOM Volume

Press (+) or (-) on the headset control to raise or lower volume.

## Headset Receptacles

The driver's headset receptacle is located on the left side of the motorcycle below the fuel tank.

The passenger headset receptacle (if equipped) is located on the left side of the motorcycle on the forward side of the saddlebag.

## VOX Break Setting

The intercom is opened and closed using a voice-operated switch (VOX). The volume sensitivity level required to open the intercom can be adjusted using the VOX sensitivity setting.

Press and hold ICOM on the upper left control to access the VOX sensitivity set screen.



Push COM or ICOM to adjust the sensitivity setting.

**Tip:** Lower settings require less volume to open the intercom. If wind or ambient vehicle noise trigger the VOX to open, set the VOX sensitivity to a higher level.

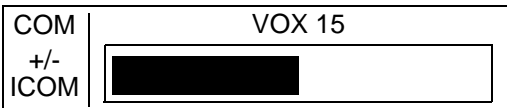

“VOX” will display on the console screen whenever the driver or passenger are communicating over the intercom system.

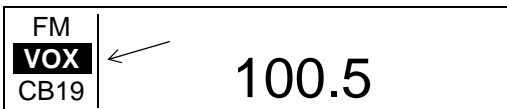

## Getting Started

The ignition key must be in the ACC or ON position to use the audio system.

**Tip:** To prevent battery drain, do not leave the key in the ACC position for long periods. VICTORY recommends using the audio system only when the engine is running.

Press VOL (+) to turn the audio system on. Press and release the MODE button until AUX or iPod is active.

When AUX is active, the console screen will display “AUX” as the active source.

AUX ICOM CB19	←	NAV MP3
---------------------	---	---------

When iPod is active, the console screen will display “iPod” as the active source and iPod information in the display screen.

iPod ICOM CB19	Artist Song Title Playlist
----------------------	----------------------------------

To change the mode, press the MODE button repeatedly to toggle to the AUX mode.

Press TUNE (+) or TUNE (-) to set the mode to AUX (for iPod or any other MP3 player use) or to NAV MP3 for navigation unit MP3 player use.

**Tip:** NAV MP3 mode will override any device connected with an input cable.

+ TUNE -	AUX MODE AUX
----------------	-----------------

+ TUNE -	AUX MODE NAV MP3
----------------	---------------------

## iPod Song Control

Press and release TUNE (+) or TUNE (-) to change the tracks in the currently selected playlist.

**Tip:** Generic MP3 players can play music, but cannot be controlled through the audio system (for example, selecting tracks or playlists).

Press and *hold* TUNE (+) or TUNE (-) to fast-forward or fast-reverse in the currently playing song.

A quick double press and release of TUNE (+) or TUNE (-) will bring up a list of songs in the currently selected playlist.

+ TUNE -	Brown Sugar <b>Gimme Shelter 2</b> Honky Tonk Woman
----------------	---

Use TUNE (+) or TUNE (-) to scroll through this song list. The selected song will be in reverse video on the center line of the display. Press and release the PRE button to select and play the highlighted song, or press and release the MODE button to exit without selecting a new song.

## AUX / iPod iPod Playlists

To browse tracks by artist, playlist or album, press and hold the PRE button to bring up the selection screen. Press TUNE (+) or TUNE (-) to highlight the desired category.

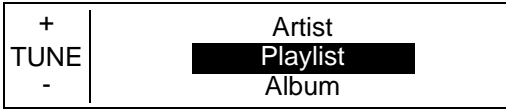

Press and release the PRE button to bring up the items in the selected category. When a category is selected, a list of items in that category are displayed with the active track highlighted.

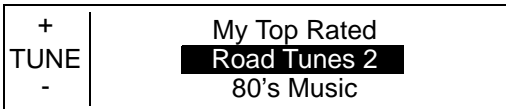

Press TUNE (+) or TUNE (-) to make a selection.

Press and release the PRE button to select the highlighted item and play the first track within that item.



**Tip:** Press and release the MODE button to exit without making a selection.

## iPod Tuning

Press TUNE (+) or TUNE (-) once to move one track forward or backward. Press and hold the button to advance fast-forward or fast-reverse. Press the button twice (double click) to bring up the track selection screen, then use the TUNE button to move forward and backward through the playlist.

When the desired track is highlighted, press and release the PRE button to select the track.

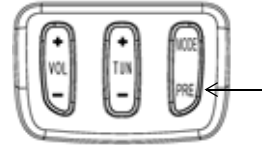

**Tip:** To exit the screen without changing tracks, press and release the MODE button.

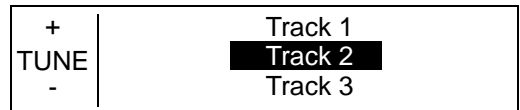

## About XM Radio

XM is North America's number one satellite radio company, offering an extraordinary variety of commercial-free music, plus the best in premier sports, news, talk radio, comedy, children's and entertainment programming, broadcast in superior digital audio quality coast to coast.

For more information, or to subscribe, U.S. customers visit [xmradio.com](http://xmradio.com) or call XM Listener Care at 1-800-XMRADIO (1-800-967-2346); Canadian customers visit [xmradio.ca](http://xmradio.ca) or call XM Listener Care at 1-877-GETXMSR (1-877-438-9677).

## XM Ready® Legal

XM monthly service subscription sold separately. XM Mini-Tuner and Home Dock required (each sold separately) to receive XM service. It is prohibited to copy, decompile, disassemble, reverse engineer, hack, manipulate or otherwise make available any technology or software incorporated in receivers compatible with the XM satellite Radio System. Installation costs and other fees and taxes, including a one-time activation fee may apply. All fees and programming subject to change. Channels with frequent explicit language are indicated with an XL. Channel blocking is available for XM radio receivers by calling 1-800-XMRADIO (U.S.residents) and 1-877-GETXMSR (Canadian residents). Only available in the 48 contiguous United States and Canada. ©2007 XM Satellite Radio Inc. All rights reserved.

## XM Ready® Subscription

Once you have installed the XM Mini-Tuner Home Dock, inserted the XM Mini-Tuner, connected the XM Mini-Tuner Home Dock to your XM Ready audio system, and installed the antenna, you are ready to subscribe and begin receiving XM programming.

There are three places to find your eight character XM Radio ID: On the XM Mini-Tuner, on the XM Mini-Tuner package, and on XM Channel 0.

Record the Radio ID below for reference.

**Tip:** The XM Radio ID does not use the letters "I", "O", "S" or "F".

--	--	--	--	--	--	--	--

Activate your XM Satellite Radio service in the U.S. online at <http://activate.xmradio.com> or call 1-800-XMRADIO (1-800-967-2346). Activate your XM Satellite Radio service in Canada online at <https://activate.xmradio.ca> or call 1-877-GETXMSR (1-877-438-9677). You will need a major credit card. XM will send a signal from the satellites to activate the full channel lineup. Activation normally takes 10-15 minutes, but during peak busy periods you may need to keep your XM Ready audio system on for up to an hour. When you can access the full lineup on your XM Ready audio system you are done.

# XM Radio

## Getting Started

The ignition key must be in the ACC or ON position to use the audio system.

**Tip:** To prevent battery drain, do not leave the key in the ACC position for long periods. VICTORY recommends using the audio system only when the engine is running.

Press VOL (+) to turn the audio system on. Press and release the MODE button until the XM radio is the active source.

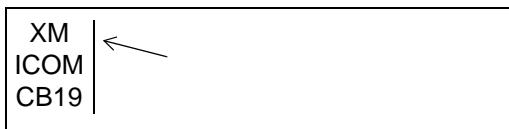

When the XM radio is active, the console screen will display radio channel, preset number (if applicable), channel name or category, artist, and song title.

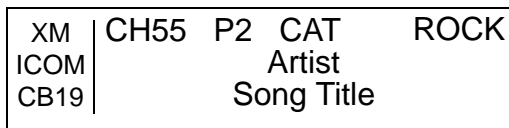

## XM Radio Reception

If the XM radio system is not receiving a signal due to being indoors (or any overhead obstruction), “No Signal” appears on the display.



**Tip:** If the antenna is disconnected, “Antenna” will display.

## XM Radio Menu Options

The XM radio system has unique menus that apply only to this system when the XM radio is the active source. Some settings such as bass, treble, fader, etc. apply to both the audio system and the XM radio system.

Menus specific to the XM radio system are:

**XM Display** (Category or Channel Name)

**XM Category** (Rock, Country, Traffic, Sports, All Channels, Talk News, etc.)

**XM Tune Mode** (Seek/Scan)

**Tip:** XM Tune Mode is unique to the XM radio system.

## XM Radio Settings

To access the menus, turn the audio system power on and change the active source to XM Radio.

Press the MODE button repeatedly to toggle to the XM DISPLAY menu.

Press TUNE (+) or TUNE (-) to select CATEGORY or CHANNEL NAME.



In the CATEGORY mode, the category of a selected station will display in the upper right corner of the screen.

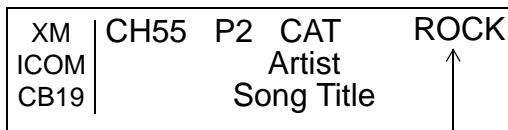

In the CHANNEL NAME mode, the name of the selected channel will display.

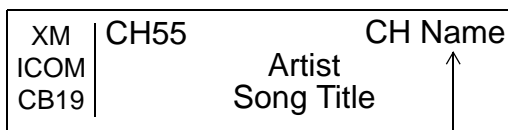



## XM Radio Categories

With XM as the active source, use the MODE button to scroll to the XM Category menu.

Press TUNE (+) or TUNE (-) on the left control to change the category.



## XM Radio Channels

Press TUNE (+) or TUNE (-) on the left control to change the channel.

The ALL CHANNELS category must be selected to scroll through every available channel in numerical order.

If a specific category (other than ALL CHANNELS) is selected, only channels within that category will be selected with the TUNE button.

**Tip:** If a preset button is used to tune a station that is not within the currently active category and the TUNE button is used to change the channel, it will tune stations within the previously selected category, not within the category of the preset station.

# NAV MP3

## Navigation MP3 Introduction

Please read this manual and the GARMIN ZUMO 660 NAV MP3 information provided with your player to become familiar with all unit features and operation.

The audio integration kit must be installed to enable outputs from the NAV MP3 (such as navigation instructions or user-loaded MP3 media files) to play through the headsets or speakers. The unit is fully functional without the kit installed, but there will be no interface with the vehicle's audio system.

## Navigation MP3 Operation Tips

- Signals coming from the NAV MP3 unit will override any source of the motorcycle's audio system to ensure navigation instructions are communicated when needed. The signals will also override the MP3 player.
- You must set volume levels within the NAV MP3 unit. Volume settings in the motorcycle's audio system control NAV MP3 volume, but navigation instructions may be difficult to hear if volume levels in the unit are set too low. See the GARMIN information for setting procedures. The recommended initial settings are 100/80/80: MASTER 100%, NAVIGATION 80%, MEDIA 80%.
- Pause or stop the MP3 player to switch to radio.
- To switch from radio to MP3 player, change the active source to AUX. For best sound quality, change the AUX mode setting on the radio from AUX to NAV MP3 when listening to the MP3 player. Audio works in the AUX setting, but the levels are not optimized.
- If playing MP3 files from the GARMIN ZUMO 660 unit, you may need to turn down the "media volume" on the GARMIN unit to avoid distortion.

## Changing to NAV MP3 Mode

The ignition key must be in the ACC or ON position to use the audio system.

Press VOL (+) to turn the audio system on.

Press and release the MODE button until AUX is the active source.



To change the mode, press the MODE button repeatedly to toggle to the AUX mode.

Press TUNE (+) or TUNE (-) to set the mode to AUX (for iPod or any other MP3 player use) or to NAV MP3 for navigation unit MP3 player use.

## A

About the Rider's Manual . . . . .	5
Accelerating . . . . .	48
Accessories, How to Choose . . . . .	10
Air Filter . . . . .	58
Apparel for Riding . . . . .	9
Audio Controls . . . . .	100
Audio Memory Presets . . . . .	104
Audio Mode Menus . . . . .	105-108
Audio Source Selection . . . . .	103
Audio Switches . . . . .	30
Audio System . . . . .	100
Audio System Power . . . . .	102
Audio Tuning . . . . .	104
Audio Volume . . . . .	102

## B

### Battery

Charging . . . . .	76
Installation . . . . .	76
Removal . . . . .	75
Safety Warnings . . . . .	75
Brake Fluid Level, Front Brake . . . . .	39
Brake Fluid Level, Rear Brake . . . . .	40
Brake Fluid, Front Brake . . . . .	72
Brake Fluid, Rear Brake . . . . .	71
Brake Lever Inspection . . . . .	39
Brake Lever, Front Brakes . . . . .	33, 72
Brake Line Inspection . . . . .	40
Brake Pad Inspection . . . . .	41
Brake Pedal Adjustment . . . . .	34
Brake Pedal Inspection . . . . .	40
Brake Pedal, Rear Brakes . . . . .	33, 71

### Brakes

Brake Fluid Precautions . . . . .	71
Brake Lever Inspection . . . . .	39
Brake Line Inspection . . . . .	40
Brake Pad Inspection . . . . .	41
Brake Pedal Inspection . . . . .	40
Disc Inspection/Cleaning . . . . .	72
Front Brake Fluid . . . . .	39, 72
Front Brake Lever . . . . .	33, 72
Hoses/Connections . . . . .	73
Rear Brake Fluid . . . . .	40, 71
Rear Brake Pedal . . . . .	33, 71

## B

Braking . . . . .	49
Break-In Maintenance . . . . .	54
Break-In, Engine . . . . .	44
Breather Hose Inspection . . . . .	67

## C

Cargo Distribution . . . . .	11
Cargo Safety . . . . .	11
CB Channels . . . . .	109
CB Headset ENT Mode . . . . .	106
CB Headset Volume Controls . . . . .	106
CB Radio . . . . .	109
CB Radio Frequencies . . . . .	111
CB Radio Mode, Local/Distant . . . . .	111
CB Radio Volume, Driver . . . . .	110
CB Radio Volume, Passenger . . . . .	110
Check Engine Indicator . . . . .	23, 26
Citizens Band (CB) Radio . . . . .	101
Cleaning Products . . . . .	85
Clock, Resetting . . . . .	22, 27
Clutch Cable Lubrication, Mechanical . . . . .	70
Clutch Inspection, Mechanical . . . . .	41
Clutch Lever . . . . .	32
Clutch Lever Freeplay, Mechanical . . . . .	69
Clutch Lever Lubrication, Mechanical . . . . .	70
Compliance, Vehicle . . . . .	13

### Component Locations

Console . . . . .	18
Left Side . . . . .	17
Right Side . . . . .	17
Top View . . . . .	18
Console Components . . . . .	18
Cruise Control Cable Inspection . . . . .	69
Cruise Control Operation . . . . .	49-50

## D

Diagnostic Functionality . . . . .	22
Display Units, Standard/Metric . . . . .	22, 27
<b>Drive Belt</b>	
Cleaning . . . . .	63
Condition . . . . .	60
Rear Wheel Alignment . . . . .	63
Tension Adjustment . . . . .	63
Tension Data . . . . .	61
Tension Inspection . . . . .	61-62
Wear Analysis . . . . .	60
Drive Belt Inspection . . . . .	42
Drive Belt/Rear Wheel Alignment . . . . .	63

# Index

## E

Electrical Precautions	81
Elevating the Motorcycle	82
Emission Control System Inspection	67
Engine Break-In	44
Engine Compression Test	81
Engine Identification Number	16
Engine Starter Switch	31
Engine Stop/Run Switch	31
Engine, Starting	46
Engine, Stopping	51
Equipment Modifications	10
Error Codes, Engine	23, 26
Exhaust Safety	12
Exhaust System Inspection	81

## F

Fastener Inspection	43, 77
Fastener Torques	82

### Fluid Change

Engine Oil	57
------------	----

### Fluid Level

Engine Oil	38
Front Brake	39
Front Brake Fluid	72
Rear Brake	40
Rear Brake Fluid	71
Fork Inspection	66
Fuel Cap	35
Fuel Gauge	24
Fuel Handling Safety	12
Fuel Level	38
Fuel Recommendation	99
Fuel System Inspection	67
Fuel System, Priming	45
Fuel Tank Removal/Installation	58-59
Fueling	45
Fuse Recommendations	80
Fuse Replacement	80

## G

Gasoline Handling Safety	12
Gear Shift Pedal	33
Gear Shift Pedal Adjustment	34
Gear Shifting	47-48
Gross Vehicle Weight Rating	14
GVWR	14

## H

Hand Grip Heater Switch	28
Handlebar Switches, Left	29-30
Handlebar Switches, Right	31
Headlight Aim Adjustment	79
Headlight Aim Inspection	78
Headlight Lamp Replacement	79
Headset Receptacles	112
Headset Use	109

## I

Identification Number Record	99
Idle Inspection	67
Ignition Key Number	16
Ignition Switch	19
Ignition Switch Lubrication	76
Indicator Lamps	20, 25
Information Labels	15

### Instrument Cluster

CROSS COUNTRY	24-28
CROSS ROADS	20-23
Intercom System	109, 112
iPod Playlists	114
iPod Song Control	113
iPod Tuning	114

## K

Key Number	16
------------	----

## L

Labels, Information	15
Labels, Safety	15
Leather, Rubber and Vinyl Care	89
Lock Lubrication	76
Locking Saddlebags	35

## M

### Maintenance

Break-In Maintenance	54
Major Maintenance	54
Periodic Maintenance	54-55
Maintenance for Safety	13
Maintenance Log	56
Maintenance Safety	53
Maintenance, Required	13
Major Maintenance	54
Metric Display	22, 27

## M

<b>MFD</b>	
CROSS COUNTRY	26-28
CROSS ROADS	21-23
Mode Button	30
Modifications, Vehicle	10
Motorcycle Safety Foundation	6
MP3 Player	118
<b>Multi-Function Display</b>	
CROSS COUNTRY	26-28
CROSS ROADS	21-23

## N

Navigation MP3	118
----------------	-----

## O

Odometer	28
Oil Change, Engine Oil/Filter	57
Oil Level, Engine Oil	38
Oil Recommendation	99

## P

Parking	51
Parking on a Slope	51
Parking on a Soft Surface	51
Parking the Motorcycle	10
Passenger Safety	9
Pedal Adjustment	34
Periodic Maintenance	54-55
Polished Aluminum Care	87
Polishing the Motorcycle	87-89
Protectants, Leather, Rubber, Vinyl	89
Push-to-Talk (PTT)	110

## R

Radio Frequencies	100
Radio Frequencies, CB	111
Rear Axle Inspection	65
Refueling Safety	12
Reverse Operation	52
Riding Safety	6-9
Road Testing	54, 82

## S

Saddlebag Lock	35
Saddlebags, Using Safely	11
Safety Defects, Reporting to NHTSA	15
Safety Gear	9
Safety Labels	15
Safety Symbols	5
Safety While Servicing	53
Seat Removal/Installation	78
Service Manual	84
Service Procedure Safety	53
Shift Points	48
Shifting Gears	47-48
Side Covers, Removal/Installation	77
Sidestand	34
Sidestand Inspection	43
Sidestand Lubrication	77
Signal Words	5
Spark Plugs	74
Speedometer	20, 24
Squelch	110
Starter Interlock Switch	30
Steering Head Inspection	66
Steering Inspection	42
<b>Storage</b>	
Battery Care	91
Clean/Protect the Motorcycle	90
Engine Protection	91
Fuel Stabilizer	90
Maintenance During	91
Motorcycle Cover	91
Removal From	92
Rodents	91
Storage Area	90
Tire Inflation	90
Suspension Adjustment, Rear	64-65
Suspension Inspection, Front	42, 65-66
Suspension Inspection, Rear	42
Swing Arm Inspection	65

# Index

## S

### Switches

Audio Switches . . . . .	30
Emergency Flasher Switch . . . . .	29
Engine Starter Switch . . . . .	31
Engine Stop/Run Switch . . . . .	31
Hand Grip Heater Switch. . . . .	28
Hazard Switch . . . . .	29
High Beam/Low Beam Switch . . . . .	29
Horn Button . . . . .	29
Ignition Switch . . . . .	19
Ignition Switch Lubrication . . . . .	76
Mode Button . . . . .	30
Starter Interlock Switch . . . . .	30
Turn Signal Switch . . . . .	29
Switches, Console (Cross Country). . . . .	28
Switches, Left Handlebar. . . . .	29-30
Switches, Right Handlebar . . . . .	31

## T

Tachometer . . . . .	24
Testing After Servicing . . . . .	54, 82
Throttle Cable Freeplay . . . . .	68
Throttle Cable Lubrication . . . . .	69
Throttle Control Grip. . . . .	32
Throttle Control Inspection . . . . .	68
Throttle Freeplay . . . . .	41
Throttle Inspection. . . . .	41
Tilt Sensor . . . . .	32

### Tires

Condition . . . . .	73
Pressure . . . . .	74
Recommended Pressure. . . . .	74
Recommended Type . . . . .	74
Tire Condition . . . . .	39
Tire Pressure . . . . .	39
Tread Depth . . . . .	39, 73
Wheel Inspection . . . . .	73
Tool Kit . . . . .	35
Transporting the Motorcycle . . . . .	12
Trip Odometer . . . . .	28
Troubleshooting. . . . .	83-84
Turn Signal Switch . . . . .	29

## V

VICTORY Cleaning Products . . . . .	85
Volt Meter . . . . .	24

## W

Washing the Motorcycle . . . . .	85-87
Weather Band (WX) . . . . .	108
Weight Capacity . . . . .	14
Wheel Inspection . . . . .	73

## X

XM Radio Categories . . . . .	117
XM Radio Channels . . . . .	117
XM Radio Introduction . . . . .	115
XM Radio Menu Options . . . . .	116
XM Radio Reception. . . . .	116
XM Ready Legal . . . . .	115
XM Ready Subscription . . . . .	115