

# 2012



**POLARIS**<sup>®</sup>  
The Way Out.

Owner's Manual for Maintenance and Safety

# OUTLAW<sup>®</sup> 50

**Read this manual carefully. It contains important safety information.  
Adult supervision is required at all times.  
Operation is prohibited for anyone under 6 years of age.**

**⚠ WARNING**

The engine exhaust from this product contains chemicals known to the State of California to cause cancer, birth defects or other reproductive harm.

A card containing important ATV safety information should be attached to the owner's manual on the next page. If you cannot locate this card, or if it has been removed, please call 1-800-342-3764 for assistance.

# ⚠️ WARNING

Improper vehicle use can result in  
**SEVERE INJURY or DEATH.**



ALWAYS USE  
AN APPROVED  
HELMET AND  
PROTECTIVE  
GEAR



NEVER USE  
ON PUBLIC  
ROADS



NEVER CARRY  
PASSENGERS



NEVER USE  
WITH DRUGS  
OR ALCOHOL

**READ OWNER'S MANUAL.  
FOLLOW ALL INSTRUCTIONS AND WARNINGS.**

**NEVER** operate:

- without proper training or instruction
- at speeds too fast for your skills or the conditions
- on public roads - a collision can occur with another vehicle
- with a passenger - passengers affect balance and steering and increase risk of losing control

**ALWAYS:**

- use proper riding techniques to avoid vehicle overturns on hills and rough terrain and in turns
- avoid paved surfaces - pavement may seriously affect handling and control



**POLARIS**  
The Way Out.®

For your nearest Polaris dealer, call 1-800-POLARIS  
or visit [www.polarisindustries.com](http://www.polarisindustries.com)  
Polaris Sales Inc., 2100 Hwy 55  
Medina, MN 55340  
Phone 1-888-704-5290  
Part No. 9923574 Rev 01  
Printed in Taiwan



Visit us at [www.polarisindustries.com](http://www.polarisindustries.com)



POLARIS, THE WAY OUT and OUTLAW are registered trademarks of POLARIS Industries Inc.

Copyright 2011 POLARIS Sales Inc. All information contained within this publication is based on the latest product information at the time of publication. Due to constant improvements in the design and quality of production components, some minor discrepancies may result between the actual vehicle and the information presented in this publication. Depictions and/or procedures in this publication are intended for reference use only. No liability can be accepted for omissions or inaccuracies. Any reprinting or reuse of the depictions and/or procedures contained within, whether whole or in part, is expressly prohibited.

The original instructions for this vehicle are in English. Other languages are provided as translations of the original instructions.

Printed in Taiwan

2012 OUTLAW 50 ATV Owner's Manual P/N 9923574

# Welcome

## Dear Parents:

We believe your children should have the opportunity to enjoy The Way Out experience along with you. We've provided this owner's manual to assist you and your children in learning about safe operation and care of your new ATV.

*A POLARIS ATV is not a toy and can be hazardous to operate. Make sure any child who will operate the ATV takes a training course before operating the ATV. Make sure all operators understand and follow all of the instructions and warnings contained in this owner's manual.* Help them also learn to show respect for our environment and for the rights of others while operating the ATV.

*Never allow a child under the age of 16 to operate an ATV without adult supervision.* Children differ in skills, physical abilities and judgement. Some children may not be able to operate an ATV safely. Permit continued use only if you determine that your child has the ability and maturity to operate the ATV safely.

The preventive maintenance program outlined in this manual is designed to ensure that all critical components on your child's ATV are thoroughly inspected at specific intervals. Follow all of the instructions and recommendations in this manual.

# **Welcome**

## **Dear Children:**

Before you ride your new POLARIS ATV, there are some important things that you need to know. You must learn how to keep yourself and those around you safe while you're riding. Your parents and POLARIS want you to enjoy riding your new ATV, and that's why you need to read and understand the information in your owner's manual. You must also take an ATV training course before you begin riding.

Ask your parents to explain anything you don't understand, and pay close attention to the warnings and instructions you read. Your safety and the safety of others is the most important thing to think about at all times. Never drive your ATV alone. Always make sure an adult is watching you when you ride.

Drive safely and enjoy riding your new POLARIS ATV!

## Table of Contents

<b>Introduction</b> . . . . .	<b>6</b>	<b>Adult Section</b> . . . . .	<b>55</b>
<b>Safety</b> . . . . .	<b>8</b>	Vehicle ID Numbers . . . . .	56
<b>Youth Section</b> . . . . .	<b>39</b>	Features and Controls . . . . .	57
Know Your ATV . . . . .	40	Operation . . . . .	70
Pre-Ride Check . . . . .	47	Emission Control Systems . . . . .	92
Riding Rules . . . . .	50	Maintenance . . . . .	94
		Specifications . . . . .	156
		POLARIS Products . . . . .	158
		Troubleshooting . . . . .	160
		Warranty . . . . .	166
		Maintenance Log . . . . .	181
		<b>Index</b> . . . . .	<b>185</b>



# Introduction

## Safety Words and Symbols

The following signal words and symbols appear throughout this manual and on your vehicle. Your safety is involved when these words and symbols are used. Become familiar with their meanings before reading the manual.



The safety alert symbol indicates a potential personal injury hazard.

### **WARNING**

A **WARNING** indicates a hazardous situation which, if not avoided, may result in death or serious injury.

### **CAUTION**

A **CAUTION** indicates a hazardous situation which, if not avoided, may result in minor or moderate injury.

### **NOTICE**

A **NOTICE** indicates a situation that may result in property damage.



The Prohibition Safety Sign indicates an action **NOT** to take in order to avoid a hazard.



The Mandatory Action Sign indicates an action that **NEEDS** to be taken to avoid a hazard.

## **WARNING**

Failure to follow the warnings and safety precautions contained in this manual can result in severe injury or death. A POLARIS ATV is not a toy and can be hazardous to operate. This vehicle handles differently than other vehicles, such as motorcycles and cars. A collision or rollover can occur quickly, even during routine maneuvers like turning, or driving on hills or over obstacles, if you fail to take proper precautions.

- Read this owner's manual. Understand all safety warnings, precautions and operating procedures before operating a POLARIS ATV. Keep this manual with the ATV.
- Never operate an ATV without proper instruction. Take a training course.
- Always follow the age guidelines for your vehicle. Y-12 90cc models are designed for children not less than 12 years of age and Y-6 50cc models are designed for children not less than 6 years of age. No child under the age of 16 should ride any ATV designed and sold for an adult.
- Never permit a guest to operate the ATV unless the guest has read this manual and all product labels and has completed a certified safety training course.

## Safety

### Safety Training

ATV safety training is a top priority for POLARIS. POLARIS strongly encourages you and any family members who will be riding the ATV to take a training course.

If you purchased a new POLARIS ATV in the United States, your dealer provided information about the authorized ATV *RiderCourse*<sup>sm</sup> that is available to you and your eligible family members. This training is included in the purchase price of your ATV.

In addition, you were provided with printed material and a video or DVD that instructs operators on safe operating procedures. You should review this information with your child on a regular basis. Do not allow other children to ride this ATV unless they have read the manual, seen the instructional video or DVD and taken and completed an approved ATV safety training course.

### Safety Training

If you purchased a used POLARIS ATV in the United States, you can enroll in the *ATV RiderCourse*<sup>sm</sup> for a fee. Call ATV Enrollment Express at (800) 887-2887 or visit [www.atvsafety.org](http://www.atvsafety.org).

If you purchased a POLARIS ATV outside the United States, please contact your dealer or local law enforcement agencies for information about safety training.

**FOR MORE INFORMATION ABOUT ATV SAFETY in the United States, call the Consumer Product Safety Commission at 1-800-638-2772, or visit [www.cpsc.gov](http://www.cpsc.gov), visit [www.atvsafety.org](http://www.atvsafety.org), or call POLARIS at 1-800-342-3764.**

## Safety Riding Gear

Always wear clothing suited to the type of riding. ATV riding requires special protective clothing for comfort and to reduce the chance of injury.

### Helmet

Wearing a helmet can prevent a severe head injury. Whenever riding a POLARIS vehicle, always wear a helmet that meets or exceeds established safety standards.

Approved helmets in the USA and Canada bear a U.S. Department of Transportation (DOT) label.

Approved helmets in Europe, Asia and Oceania bear the ECE 22.05 label. The ECE mark consists of a circle surrounding the letter E, followed by the distinguishing number of the country which has granted approval. The approval number and serial number will also be displayed on the label.

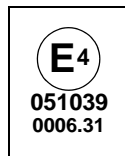
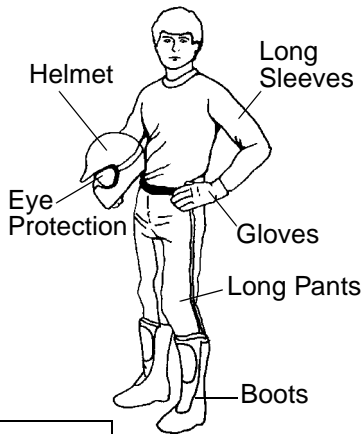

## Riding Gear

### Eye Protection

Do not depend on eyeglasses or sunglasses for eye protection. Whenever riding a POLARIS vehicle, always wear shatterproof goggles or use a shatterproof helmet face shield.

POLARIS recommends wearing approved Personal Protective Equipment (PPE) bearing markings such as VESC 8, V-8, Z87.1, or CE. Make sure protective eye wear is kept clean.

### Gloves

Off-road style gloves with knuckle pads are the best for comfort and protection.

### Boots

The best footwear is a pair of strong over-the-calf boots with low heels.

### Clothing

Always wear long sleeves and long pants to protect arms and legs. Riding pants with knee-pads and a jersey with shoulder pads provide the best protection.

# **Safety**

## **Equipment Modifications**

We are concerned for the safety of our customers and for the general public. Therefore, we strongly recommend that consumers do not install on a POLARIS ATV any equipment that may increase the speed or power of the vehicle, or make any other modifications to the vehicle for these purposes. Any modifications to the original equipment of the vehicle create a substantial safety hazard and increase the risk of bodily injury.

The warranty on your POLARIS ATV is terminated if any equipment has been added to the vehicle, or if any modifications have been made to the vehicle, that increase its speed or power.

The addition of certain accessories may change the handling characteristics of the ATV. Use only POLARIS-approved accessories, and familiarize yourself with their function and effect on the ATV.

## Safety Warnings

### **WARNING**

Failure to operate the ATV properly can result in a collision, loss of control, accident or overturn, which may result in serious injury or death.

Be sure to read all of the following warnings about driving hazards and how to avoid them. These warnings are provided for your child's safety. Be sure to explain to your young driver that the hazards outlined in this section of the owner's manual **MUST** be avoided at all times. See the **RIDING RULES** section and the **OPERATION** section of the owner's manual for proper operating procedures.

### **Operator Restrictions/Age Restrictions**

This vehicle is for recreational use by young operators under adult supervision **ONLY**.

Operation is prohibited for anyone under 6 years of age.





# Safety

## Safety Warnings

### Operating Without Instruction

Operating this ATV without proper instruction increases the risk of an accident. The operator must understand how to operate the ATV properly in different situations and on different types of terrain.

Beginning and inexperienced operators should complete an ATV training course. They should then regularly practice the skills learned in the course and the operating techniques described in the Owner's Manual. See page 8.

Never permit a guest to operate the ATV unless the guest has read this manual and all product labels and has completed a certified safety training course.

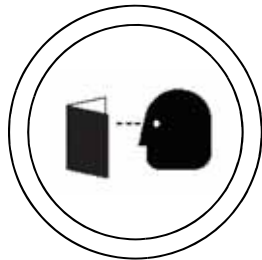

## Safety Warnings

### Handling Gasoline

Gasoline is highly flammable and explosive under certain conditions.

- Never allow a child to refuel or handle gasoline.
- Always exercise extreme caution whenever handling gasoline.
- Always refuel with the engine stopped, and outdoors or in a well ventilated area.
- Do not smoke or allow open flames or sparks in or near the area where refueling is performed or where gasoline is stored.
- Do not overfill the tank. Do not fill the tank neck.
- If gasoline spills on your skin or clothing, immediately wash it off with soap and water and change clothing.
- Turn the fuel valve off whenever the ATV is stored or parked. See page 66.

### Exposure to Exhaust

Engine exhaust fumes are poisonous and can cause loss of consciousness or death in a short time. Never start the engine or let it run in an enclosed area.

The engine exhaust from this product contains chemicals known to cause cancer, birth defects or other reproductive harm. Operate this vehicle only outdoors or in well-ventilated areas.

# Safety

## Safety Warnings

### Failure to Inspect Before Operating

Failure to inspect and verify that the ATV is in safe operating condition before operating increases the risk of an accident. Always inspect the ATV before each use to make sure it's in safe operating condition. Always follow all inspection and maintenance procedures and schedules described in the owner's manual.

### Protective Apparel

Operating this ATV without wearing an approved helmet increases the risk of a serious head injury in the event of an accident. Operating without eye protection could result in an accident and could increase the chance of a serious injury in the event of an accident.

Always wear an approved helmet that fits properly. Always wear eye protection (goggles or face shield), gloves, boots, a long-sleeved shirt or jacket and long pants.



## Safety Warnings

### Carrying a Passenger

Carrying a passenger greatly reduces the operator's ability to balance and control the ATV, which may result in an accident or overturn. Never carry a passenger on this ATV.



### Using Alcohol or Drugs

Operating the ATV after consuming alcohol or drugs could adversely affect operator judgment, reaction time, balance and perception. Never consume alcohol or drugs before or while operating an ATV.



# Safety

## Safety Warnings

### Operating on Pavement

Operating an ATV on paved surfaces (including sidewalks, paths, parking lots and driveways) may adversely affect the handling of the ATV and could result in loss of control and accident or overturn. Avoid operating the ATV on pavement. ATV tires are designed for off-road use. If it's unavoidable, travel slowly and avoid sudden turns or stops.

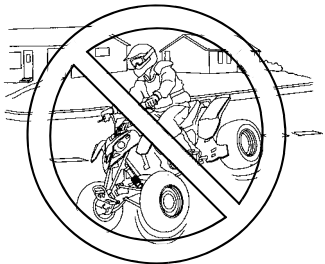

### Operating on Public Roads

Operating this ATV on public streets, roads or highways could result in a collision with another vehicle. Never operate the ATV on any public street, road or highway, including dirt and gravel roads. In many states it's unlawful to operate ATVs on public streets, roads and highways.

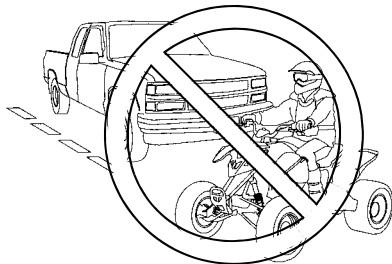

## Safety Warnings

### Operating at Excessive Speeds

Operating the ATV at excessive speeds increases the operator's risk of losing control. Always operate at a speed that's appropriate for the terrain, the visibility and operating conditions, and your experience.

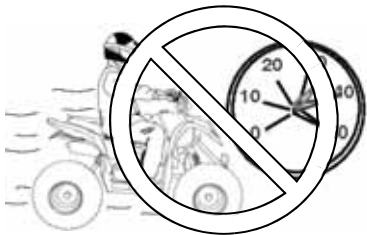

### Physical Control of the ATV

Removing a hand from the handlebars or feet from the footrests during operation can reduce your ability to control the vehicle or cause loss of balance and ejection from the ATV. If the operator's foot is not firmly planted on the footrest, it could also contact the rear wheels.

Never remove your hands from the handlebars while operating, and always keep both feet on the footrests.



# Safety

## Safety Warnings

### Turning Improperly

Turning improperly could cause loss of traction, loss of control, accident or overturn. Always follow proper procedures for turning as described in the owner's manual.

Never turn abruptly or at sharp angles. Never turn at high speeds. Practice turning at slow speeds before attempting to turn at faster speeds.

### Jumps and Stunts

Attempting wheelies, jumps and other stunts increases the risk of an accident or overturn. Never attempt wheelies, jumps, or other stunts. Avoid exhibition driving.

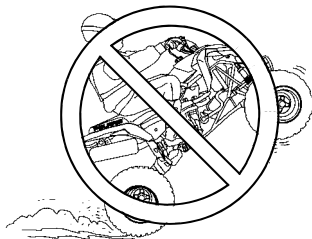

## Safety Warnings

### Improper Hill Climbing

Improper hill climbing could cause loss of control or overturn. Always follow proper procedures for climbing hills as described in the owner's manual. See page 82.

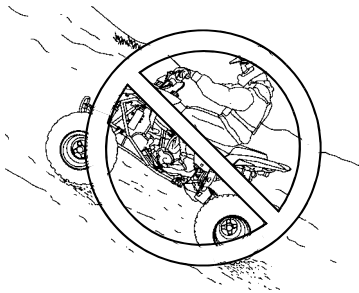

### Operating on Steep Hills

Operating on excessively steep hills could cause an overturn. Never operate on hills too steep for the ATV or for your abilities. Never operate the ATV on hills steeper than 15 degrees.

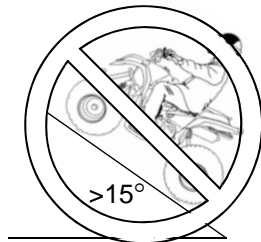



# Safety

## Safety Warnings

### Descending Hills Improperly

Improperly descending a hill could cause loss of control or overturn.

- Always follow proper procedures for traveling down hills as described in the owner's manual. **NOTE:** A special technique is required when braking while traveling downhill. See page 85.
- Always check the terrain carefully before descending a hill.
- Shift your weight rearward.
- Never travel down a hill at high speed.
- Avoid traveling down a hill at an angle, which would cause the vehicle to lean sharply to one side. Travel straight down the hill when possible.

## Safety Warnings

### Crossing Hillsides

Driving on a sidehill is not recommended. Improper procedure could cause loss of control or overturn. Avoid crossing the side of any hill unless absolutely necessary.

If crossing a hillside is unavoidable, always follow proper procedures as described in the owner's manual. See page 84.

Never attempt to turn the ATV around on any hill until you've mastered the turning technique (on level ground) as described in the owner's manual. See page 86.



# Safety

## Safety Warnings

### Stalling While Climbing a Hill

Stalling, rolling backwards or improperly dismounting while climbing a hill could cause an overturn.

Always maintain a steady speed when climbing a hill.

If all forward speed is lost

If you lose all forward speed: Keep your weight uphill. Apply the front brakes gradually (right lever). When fully stopped, apply the rear brake as well (left lever) and then lock the parking brake.

*If the ATV begins rolling downhill:* Keep weight uphill. Never apply engine power. Never apply the rear brake while rolling backwards. Apply the front brake slowly. When fully stopped, apply rear brake as well, and then lock the parking brake.

Dismount on uphill side, or to either side if pointed straight uphill. Turn the ATV around and remount, following the procedure described in the Owner's Manual. See page 86.

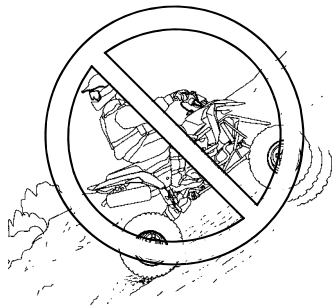

## Safety Warnings

### Operating on Slippery Terrain

Failure to use extra caution when operating on excessively rough, slippery or loose terrain could cause loss of traction, loss of control, accident or overturn.

Do not operate on excessively rough, slippery or loose terrain until you've learned and practiced the skills necessary to control the ATV on such terrain.

Always use extra caution on rough, slippery or loose terrain.

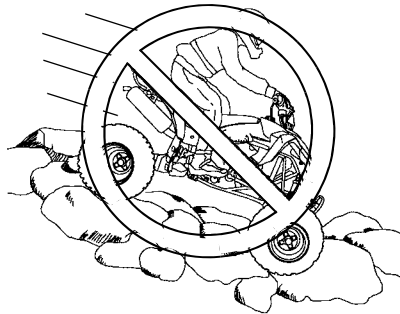

# Safety

## Safety Warnings

### Operating in Unfamiliar Terrain

Failure to use extra caution when operating on unfamiliar terrain could result in an accident or overturn. Unfamiliar terrain may contain hidden rocks, bumps, or holes that could cause loss of control or overturn.

Travel slowly and use extra caution when operating on unfamiliar terrain. Always be alert to changing terrain conditions.

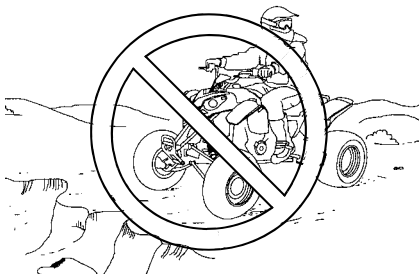

### Improper Tire Maintenance

Operating this ATV with improper tires or with improper or uneven tire pressure could cause loss of control or accident.

Always use the size and type of tires specified for your ATV. Always maintain proper tire pressure as described in the owner's manual and on safety labels.

## Safety Warnings

### Improper Vehicle Modifications

Improper installation of accessories or modification of the ATV may cause changes in handling, which could cause loss of control or an accident.

Never modify the ATV through improper installation or use of accessories. All parts and accessories added to the vehicle must be genuine POLARIS Industries Inc. or equivalent components designed for use on this ATV and should be installed and used according to approved instructions. See your authorized POLARIS ATV dealer for more information.

### Operating Over Obstacles

Improperly operating over obstacles could cause loss of control or overturn.

Before operating in a new area, check for obstacles. Avoid operating over large obstacles such as rocks and fallen trees. If unavoidable, use extreme caution and always follow proper operating procedures as outlined in this manual.

### Skidding or Sliding

Skidding or sliding can cause loss of control or overturn (if tires regain traction unexpectedly). On slippery surfaces such as ice, travel slowly and use extra caution to reduce the chance of skidding or sliding.

# Safety

## Safety Warnings

### Operating Through Deep Water

Operating the ATV through deep or fast-flowing water could cause the tires to float, causing loss of control or overturn. Avoid operating through deep or fast-flowing water. If it's unavoidable to enter water that exceeds the height of the footrests:

- Travel slowly.
- Balance your weight carefully.
- Avoid sudden movements.
- Maintain a slow and steady forward motion. Do not make sudden turns or stops, and do not make sudden throttle changes.
- Wet brakes may have reduced stopping ability. After leaving water, test the brakes. Apply them lightly several times while driving. The friction will help dry out the pads.

## Safety Warnings

### Improper Cargo Loading

Overloading the ATV or carrying/towing cargo may cause changes in handling, which could cause loss of control or an accident. Never haul cargo or tow a load with this ATV.

Never tow or pull an object behind the ATV. A wagon, sled or other towed object does not have brakes or steering. The object may overturn or collide with other objects.

Never exceed the stated load capacity for this ATV.

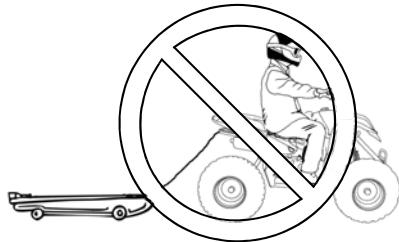



# Safety

## Safety Warnings

### Operating on Frozen Bodies of Water

Operating on frozen bodies of water may result in serious injury or death if the ATV and/or the operator fall through the ice. Never operate the ATV on a frozen body of water.

### Operating a Damaged ATV

Operating a damaged ATV can result in an accident. After any overturn or accident, have a qualified service dealer inspect the entire machine for possible damage, including (but not limited to) brakes, throttle and steering systems.

### Physical Skills

Safe operation of this rider-active vehicle requires good judgement and physical skills. Persons with cognitive or physical disabilities who operate this vehicle have an increased risk of overturn and loss of control.

## Safety Warnings

### Hot Exhaust Systems

Exhaust system components are very hot during and after use of the vehicle. Hot components can cause burns and fire. Do not touch hot exhaust system components. Always keep combustible materials away from the exhaust system.

Use caution when traveling through tall grass, especially dry grass. Always inspect the underside of the ATV after driving through tall grass, weeds, brush and other tall ground cover. Promptly remove any grass or debris clinging to the vehicle.

### Unauthorized Use of the ATV

Leaving the keys in the ignition can lead to unauthorized use of the vehicle, which could result in an accident or overturn. Always remove the ignition key when the vehicle is not in use.

# Safety

## Safety Labels and Locations

Warning labels have been placed on the vehicle for your protection. Read and follow the instructions on each label carefully. If any of the labels shown in this manual differ from the labels on your vehicle, always read and follow the instructions of the labels on the vehicle.

If an informational or graphic label becomes illegible or comes off, contact your POLARIS dealer to purchase a replacement. Replacement *safety* labels are provided by POLARIS at no charge. The part number is printed on the label.

### Discretionary Warning

#### WARNING

Never operate this ATV on HILLS steeper than 15 degrees  $\triangleleft 15^\circ$ . To prevent overturn on hilly terrain, use throttle and brakes gradually and shift weight uphill.

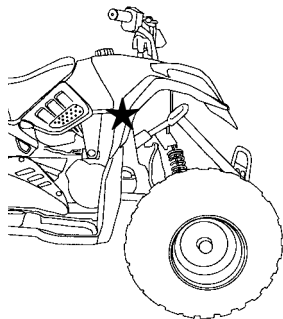

## Safety Labels and Locations

### Operation Warning

#### WARNING

Improper ATV use can result in SEVERE INJURY OR DEATH.

Always use an approved helmet and protective gear. Never use on public roads. Never carry passengers. Never use with drugs or alcohol.

**NEVER** operate: without proper training or instruction; at speeds too fast for your skills or the conditions; on public roads - a collision can occur with another vehicle; with a passenger - passengers affect balance and steering and increase risk of losing control.

**ALWAYS:** use proper riding techniques to avoid vehicle overturns on hills and rough terrain and in turns; avoid paved surfaces - pavement may seriously affect handling and control.

LOCATE AND READ OWNER'S MANUAL. FOLLOW ALL INSTRUCTIONS AND WARNINGS.

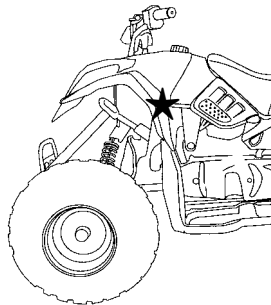

7175376

# Safety

## Safety Labels and Locations

### Age Warning

#### WARNING

Operation of this ATV by children under the age of 6 increases the risk of severe injury or death.

Adult supervision required for children under age 16.

NEVER permit children under age 6 to operate this ATV.

7175372

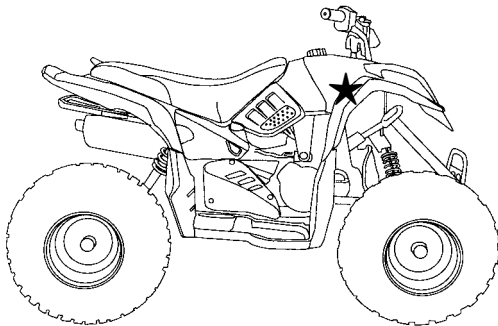

## Safety Labels and Locations

### Tire Pressure Warning

#### WARNING

Improper tire pressure or overloading can cause loss of control.

Loss of control can result in severe injury or death.

- Cold tire pressure:
  - Front: 2.0 psi (13.8 kPa)
  - Rear: 2.0 psi (13.8 kPa)
- Maximum Weight Capacity 90 lbs. (41 kg)

7176085

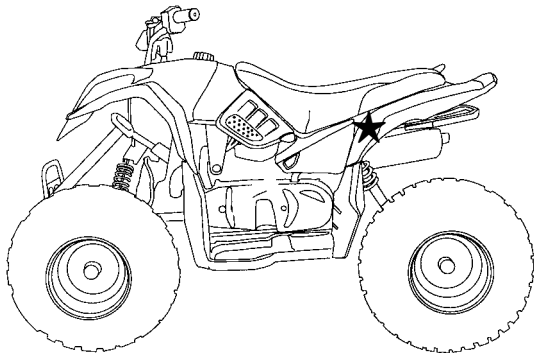

# Safety

## Safety Labels and Locations

### No Passenger Warning

WARNING

NEVER ride as a passenger.

Passengers can cause a loss of control,  
resulting in SEVERE INJURY or DEATH.

7175378

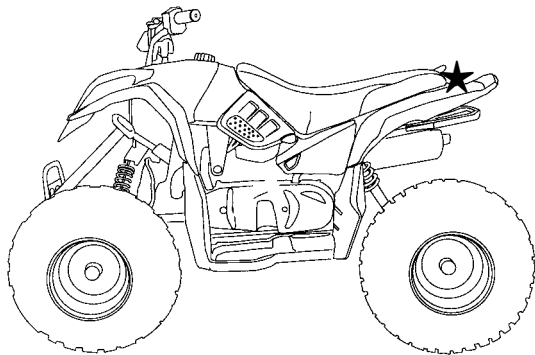

## Safety Labels and Locations

### Clutch Cover Warning

WARNING

NO STEP

- Moving parts hazard under belt-clutch guard. To prevent serious injury, do not operate vehicle with guard removed.
- Do not touch clutch cover, cover may become hot.
- Do not modify engine or clutch. Doing so can cause part failure, possible imbalance, and excessive engine RPM which can result in serious injury or death.

7174694

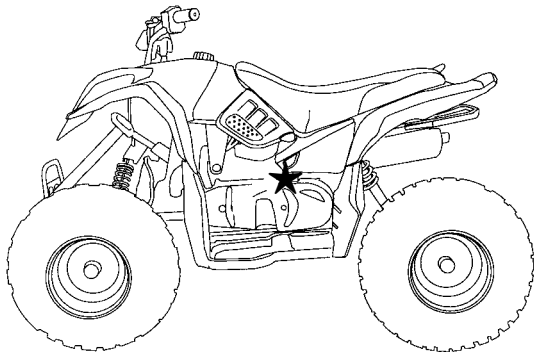



# Safety

## European Vibration and Noise

The driver-perceived noise and hand/arm and whole body vibration levels of this machinery is measured per prEN 15997.

The operating conditions of the machinery during testing:

The vehicles were in like-new condition. The environment was controlled as indicated by the test procedure(s).

The uncertainty of vibration exposure measurement is dependent on many factors, including:

- Instrument and calibration uncertainty
- Variations in the machine such as wear of components
- Variation of machine operators such as experience or physique
- Ability of the worker to reproduce typical work during measurements
- Environmental factors such as ambient noise or temperature

# Youth Section

## Know Your ATV

**PARENTS:** POLARIS Youth ATVs are equipped with a speed control system to allow adults to limit the speed of the vehicle for the rider's skill and experience. More information on speed limiting functions can be found beginning on page 122.

These units are not designed for adult use. Serious damage to the vehicle may occur if the maximum rider weight capacity is exceeded. See the specifications section beginning on page 156 for your ATV's capacity.

**CHILDREN:** Before you ride your new POLARIS ATV, there are some important things that you need to know. Your safety and the safety of others is the most important thing to think about at all times. As the driver of the ATV, you must learn how to keep yourself and those around you safe while you're riding.

Pay attention when you see this symbol:



This is the safety alert symbol. When you see this symbol on your ATV or in this manual it means **PAY ATTENTION** because you could die or be seriously injured if you don't follow the instructions.

## Know Your ATV

Before you have an adult start the engine for you for the first time, let's learn about the controls on your new ATV.

1. **Engine Stop Switch** - When the engine is running, push this button down to shut the engine off quickly. The button must be up before you can start the engine again.
2. **Horn Button** - Press the horn button to sound the horn.
3. **Throttle Control** - Press the throttle lever with your thumb when you want the ATV to go forward. Always make sure the throttle control does not stick before you drive your ATV. Read more about it on page 47.

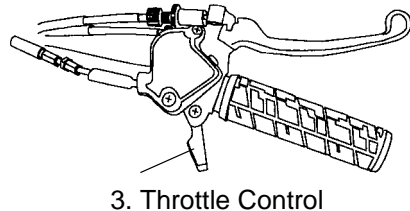
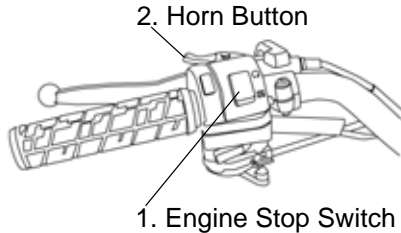

## Know Your ATV

4. **Kick-Start Lever** - If your battery is too weak to start your ATV, you can push down on the kick-start lever with your foot to start the engine. Have an adult show you how it works. Read more about how to use the kick-start on page 68.

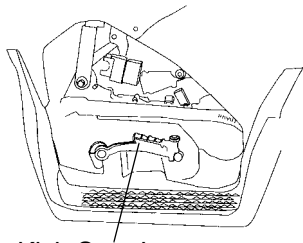

4. Kick-Start Lever

## Know Your ATV

5. **Gas Cap** - The gas cap has to be taken off when an adult puts gas in your ATV. Never take the gas cap off. Always make sure it's tightly closed.



Always have an adult put gas in your ATV. Never try to do it yourself.

6. **Seat Latch** - The seat latch is under the left edge of the seat. Reach under the left rear fender and pull back on the latch to remove the seat. To replace the seat, set it in place and push down on the seat above the latch. Always make sure the seat is locked in place before riding.

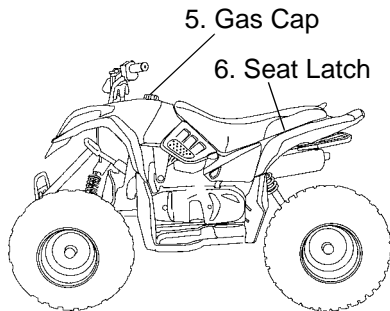

## Know Your ATV

7. **Brake Levers** - Squeeze the brake levers toward the handlebar to slow down or stop the ATV. The left lever controls the rear brake. The right lever controls the front brake. Always squeeze both brake levers at the same time.



Always squeeze both brake levers at the same time or you could lose control of the ATV and be seriously injured. Always take your thumb off the throttle lever when you squeeze the brake levers.

7. Rear Brakes



7. Front Brakes

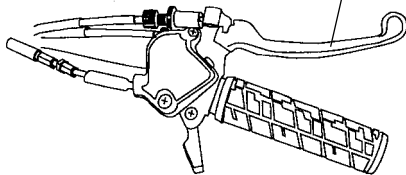

## Know Your ATV

- 8. Ignition Switch** - The ignition switch key must be turned on before pushing the start button. You can also use this key to turn off the engine.
- 9. Tether Strap and Switch** - The tether strap must always be attached snugly to your right wrist and to your ATV every time you drive. If you fall off your ATV, the tether strap will pull away from the switch and the engine will stop.



Never ride without the tether strap attached to your right wrist and to your ATV. Be careful not to let the cord get tangled around the handlebars or any part of your body.

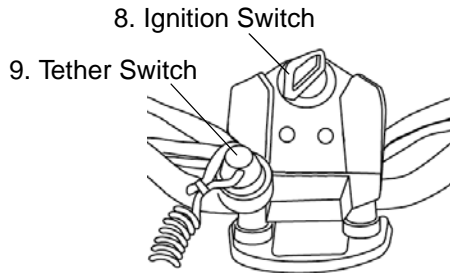



## Know Your ATV

Let's review the three ways to stop the engine of your ATV:

1. Push the engine stop switch down.
2. Pull the tether strap off the ATV.
3. Turn the key off.



## Pre-Ride Check

We're almost ready to have an adult start your ATV. But before the ATV is started for the first time, you must do a Pre-Ride Check. In fact, every time you want to ride you must have an adult help you check some things on your ATV before starting it. Let's learn about these things now.

- n Make sure the throttle doesn't stick. Check this by pushing the throttle lever toward the handlebar and then letting go. The lever should come right back to where it was before you pushed it. If it comes back slowly or stays close to the handlebar, the ATV has a sticky throttle. This means that something is wrong or broken and must be fixed before you can ride your ATV safely.



Never start the engine if you have a sticky throttle. You could be seriously hurt if you ride with a sticky throttle. Have an adult or your POLARIS dealer fix the throttle before you ride.

## Pre-Ride Check

- n Make sure the brakes don't stick. Check the brake levers by squeezing them toward the handlebar and then letting go. They should come right back to where they were before you squeezed. If they go back slowly or stay close to the handlebar, your ATV has sticky brakes. They must be fixed before you can ride your ATV safely.



Never start the engine if your ATV has sticky brakes. You could be seriously hurt if you ride with sticky brakes. Have an adult or your POLARIS dealer fix the sticky brakes before you ride.

- n Have an adult check to see if your ATV needs more gas. Children must never add their own gasoline. This must always be done by an adult. Before anyone adds gasoline to your ATV they must read the instructions and warnings on page 15 of this manual.



Always have an adult put gas in your ATV. Never try to do it yourself.

## Pre-Ride Check

- n If you used the storage area under the seat, make sure the seat is locked in place.
- n Have an adult check the engine oil level when the engine is cold. The engine is very hot after it has been running and it can burn your skin if you touch it. Children must never check the oil on their own. An adult should always be in charge of keeping the gas and oil levels at the full marks.
- n This last check is done with the engine running. You must check to make sure that all three ways to stop the engine of your ATV are working the way they should. Do you remember what they are? If you can't remember the three ways to stop the engine, go back to page 46 and review. Then have an adult help you start the engine. Practice stopping the engine all three ways.

## Riding Rules

Now you're ready to learn about riding your POLARIS ATV. There are some things you can do and there are some things you must never do. Rules are very important when you're driving an ATV. Adults have riding rules, too. The rules help keep us safe when we ride.

- ▶ The adult with you is your teacher. Always pay attention to what your teacher says so you can learn how to always drive safely.

Let's learn how to ride!



Always follow the safe riding rules found on the next pages. You or others around you could be seriously hurt if you don't follow the safe riding rules.

## Riding Rules

- ▶ Always wear the right kind of clothing and safety gear when riding your ATV.

**Helmet:** Your helmet is very important for safe riding. A helmet can prevent a severe head injury.

**Eye Protection:** Always wear shatterproof goggles or a helmet face shield, and always keep them clean so you can see where you're driving.

**Gloves:** Wear gloves to protect your hands from sun and wind. Gloves will also protect your hands from scrapes and scratches.

**Boots:** Wear sturdy boots to keep your feet dry. Boots will also protect your feet and ankles from scrapes and scratches.

**Clothing:** Make sure your clothing fits properly. If it's too small, it could keep you from moving easily when you shift your weight. If it's too big, it could hang down and get caught in a moving part. Wear long sleeves and long pants to protect your arms and legs.

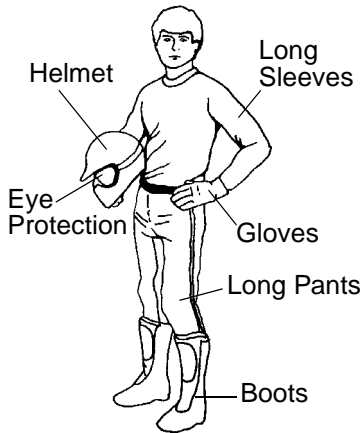

## Riding Rules

- ▶ Always attach the tether strap to your right wrist and to the ATV before riding.
- ▶ Make sure you know where you're going to drive before your ATV is started. Make sure the area is safe all around your ATV.
- ▶ Your ATV is made for one person. Never carry a passenger. A passenger will make the ATV harder to drive. You may lose control and hurt yourself and your passenger.
- ▶ Always drive your ATV while sitting down. Keep both hands on the handlebars and keep both feet on the footrests.
- ▶ Always be alert and pay attention to where you're driving. Pay attention to other drivers, and be even more careful around them because you don't know what they're going to do.
- ▶ Never follow another ATV too closely. You need lots of time and space to stop your ATV.
- ▶ Never tow or pull an object behind the ATV.

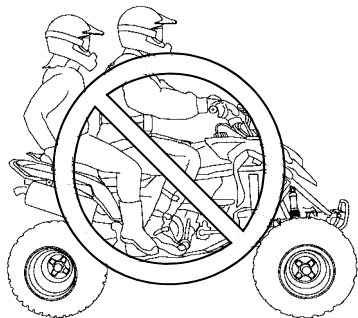

## Riding Rules

- ▶ Never ride alone. An adult should always be watching you in case you need help. Always drive within the sight of an adult.
- ▶ Never ride on public trails.
- ▶ Don't ride your ATV on roads or over railroad tracks. Your ATV makes noise that will keep you from hearing cars, trucks or trains that may be coming towards you.
- ▶ Don't ride at night. Your ATV doesn't have lights that are safe for driving in the dark.
- ▶ Learn where there are lakes, rivers, ponds and ditches in your driving area. Stay away from them.
- ▶ Never ride on frozen water. You could get hurt or you could even die. All ice can be dangerous!
- ▶ Ride your ATV only where you know it is safe to drive and where you have permission to drive. Be careful of the things around you.
- ▶ Always be a polite driver. (Don't drive through the flower garden or over the little trees you planted!)
- ▶ Always do your best to help take care of nature.



***Respect your ATV;  
respect your environment;  
and you will earn  
the respect of everyone.***

***Enjoy riding your new POLARIS ATV!***

# **Adult Section**

# Vehicle Identification Numbers

Record your ATV's identification numbers and key number in the spaces provided. Remove the spare key and store it in a safe place. An ignition key can be duplicated only by ordering a POLARIS key blank (using your key number) and mating it with one of your existing keys. The ignition switch must be replaced if all keys are lost.



Frame Identification Number

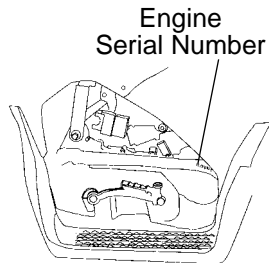

Vehicle Model Number: \_\_\_\_\_

Frame Identification Number: \_\_\_\_\_

Engine Serial Number: \_\_\_\_\_

Key Number (on the key): \_\_\_\_\_

## Features and Controls

### Main Key Switch

Turn the key clockwise to the ON position before starting the engine. To avoid draining the battery, always turn the key to the OFF position when the engine is not running.

Always remove the ignition key when the vehicle is not in use.

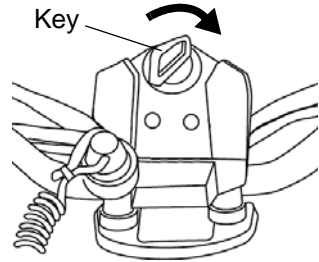

## Features and Controls

### Engine Stop Switch

The engine will not start or run when the stop switch is down, in the OFF position. Its purpose is to provide the operator with a quick means of engine shutdown in case of stuck throttle or other emergency.

Both the main switch and the engine stop switch shut off all electrical power to the entire vehicle. To stop the engine quickly, push the stop switch down.

### Choke Lever

Use the choke to start a cold engine. Push the choke lever to the left before starting the engine. When the engine starts, gradually return the choke lever to the OFF position as the engine warms up and runs smoothly.

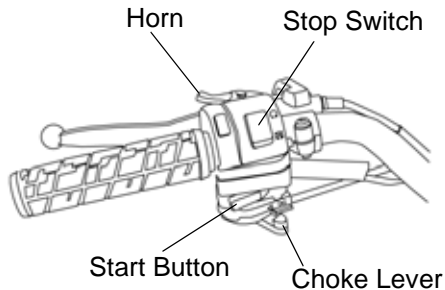

# Features and Controls

## Horn Button

Use the horn for emergencies and to let others know you're near.

## Engine Start Button

The start button is located slightly above the choke lever.

1. Attach the tether strap securely to the vehicle and to the rider's right wrist.
2. Turn the key to the ON position.
3. Lock the parking brake.
4. Push the engine stop switch up to the ON position.
5. Press the start button.

# Features and Controls

## Throttle Controls

### **WARNING**

Operating an ATV with sticking or improperly operating throttle controls could cause an accident and lead to severe injury or death.

Never start or operate an ATV with a sticking or improperly operating throttle. Always contact your dealer for service if throttle problems arise.

Failure to check or maintain proper operation of the throttle system can result in an accident if the throttle lever sticks during operation. Always check the lever for free movement and return before starting the engine. Also check occasionally during operation.

## Features and Controls

### Throttle Lever

Press the throttle lever toward the handlebar to increase engine speed and vehicle movement. Engine speed returns to idle when the lever is released.

This ATV is equipped with an Electronic Throttle Control (ETC), which is designed to reduce the risk of a frozen or stuck throttle. If the throttle cable should stick in an open position when the operator releases the throttle lever, the engine will stop and power to the rear wheels will cease.

**WARNING!** The Electronic Throttle Control (ETC) stops the engine in the event of a throttle system malfunction. Modifications to the electronic throttle control could result in failure to perform as designed, which could result in an accident. Do not attempt to modify the ETC system or replace it with any after market throttle mechanism. Always ensure that the throttle cable is installed and properly routed to the throttle control.

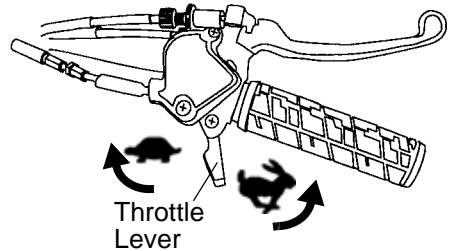



# Features and Controls

## Brakes

Squeeze both brake levers toward the handlebar at the same time to apply the brakes. The left lever controls the rear brakes. The right lever controls the front brakes.

**WARNING!** Applying only one brake could cause loss of control and result in serious injury or death. Always apply both brakes at the same time.

Rear Brakes



Front Brakes

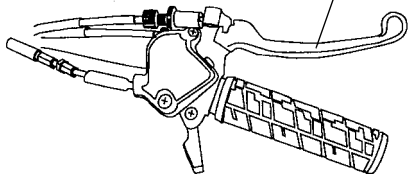

# Features and Controls

## Brakes

### Parking Brake

1. Squeeze the left brake lever.
2. Push the parking brake lock down to lock the brake lever in place.
3. Release the brake lever.
4. To release the parking brake lock, squeeze and release the brake lever. The parking brake will release automatically.

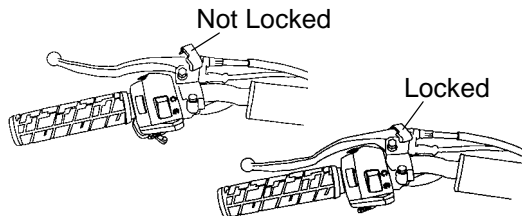

**WARNING!** Operating the ATV while the parking brake is engaged could cause an accident resulting in serious injury or death. It could also result in driveline or engine damage. Always be sure to disengage the parking brake before operating the ATV.

# Features and Controls

## Brakes

### Parking Brake

The CVT system is always in forward gear. Using the throttle to warm the engine will cause the vehicle to move forward if the parking brake is not locked. Always lock the parking brake before starting the engine. Always lock the parking brake whenever the vehicle is left unattended.

## Lights

### **WARNING**

POLARIS Youth ATVs are not equipped with lights that are designed for driving in the dark. Do not operate this ATV after dark. Use caution and drive at reduced speeds in conditions of reduced visibility. This ATV is designed for off-road use only. Do not operate this ATV on streets or highways.

# Features and Controls

## Fuel System

### Gas Cap

The fuel tank filler cap is located directly below the handlebars. Use unleaded gasoline with a minimum pump octane number of 87=(R+ M/2) octane. *Do not use fuel with ethanol content greater than 10 percent, such as E-85 fuel.*

Refer to the specifications section beginning on page 156 for fuel tank capacity.

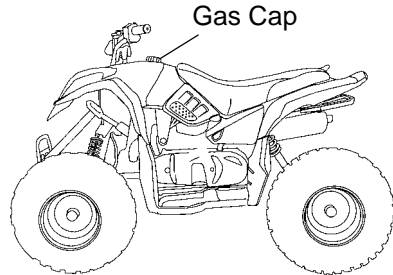

# Features and Controls

## Fuel Valve

The fuel valve is located on the left side of the ATV. It has three settings.

**OFF:** For vehicle storage and when transporting.

**ON:** For normal operation.

**RES:** For reserve supply if main supply is exhausted.

The reserve setting allows operation for approximately 7-10 miles (11-16 km). Always refill the gas tank as soon as possible after using the main supply. Always return the valve to the ON position after refueling.

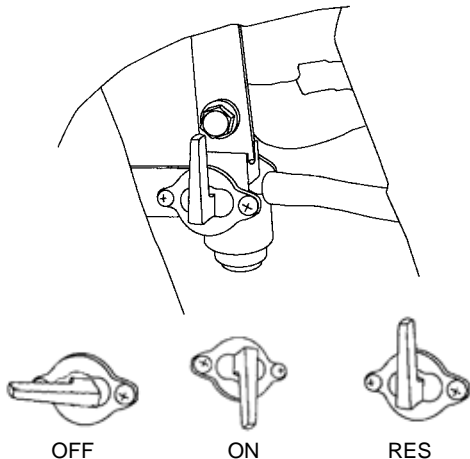

# Features and Controls

## Footwell Riser

The removable footwell risers improve riding ergonomics and provide comfort for shorter operators. An operator will also have better control of the ATV when both feet can remain firmly planted on either the footwells or the risers. If the operator's legs are long enough to comfortably reach the footwells without the risers, the risers can be removed.

1. Remove the rubber caps covering the screw access holes.
2. Remove the screws and nuts securing the footwell riser to the footwell.
3. Remove the riser.
4. Reverse the procedure to reinstall the footwell riser for shorter operators.

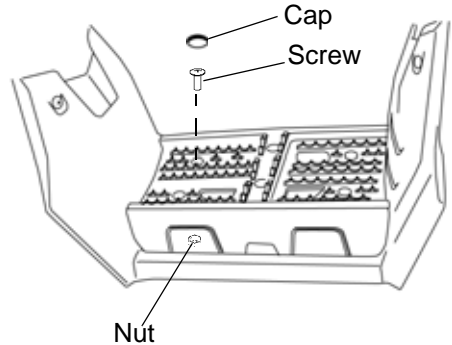

# Features and Controls

## Kick-Start Lever

If the battery becomes too weak to start the engine, use the kick-start lever to start the engine until the battery is serviced.

1. Position the vehicle on a level surface.
2. Lock the parking brake.
3. Fold out the kick-start lever on the left side of the vehicle.
4. Push the engine stop switch up to the ON position.
5. Turn the key to ON.
6. Place your foot on the kick-start, then thrust your heel downward to crank the engine.
7. After the engine has started, fold the kick-start lever back into place.

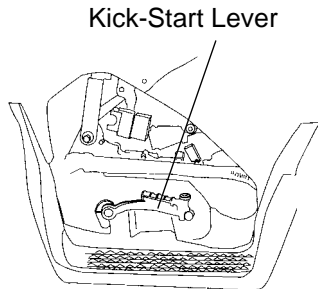

## Features and Controls

### Kick-Start Lever

8. If the kick-start lever is not installed, remove the lever from the under-seat storage area.
  9. Remove the plug from the kick-start access hole on the left side of the vehicle.
- Tip:** Store the plug in a secure location. Always reinstall the access hole plug whenever the kick-start lever is removed from the vehicle.
10. Install the kick-start lever through the access hole.



# Operation

## WARNING

Failure to operate the ATV properly can result in a collision, loss of control, accident or overturn, which may result in serious injury or death. Read and understand all safety warnings outlined in the safety section of this owner's manual.

## Break-in Period

The break-in period for your new POLARIS 4-cycle ATV is defined as the first ten hours of operation, or the time it takes to use the first two full tanks of gasoline. No single action on your part is as important as following the procedures for a proper break-in. Careful treatment of a new engine will result in more efficient performance and longer life for the engine. Perform the following procedures carefully.

**NOTICE:** Excessive heat build-up during the first three hours of operation will damage close-fitted engine parts. Do not operate at full throttle or high speeds for extended periods during the first three hours of use.

Mixing brands or using a non-recommended oil may cause serious engine damage. Always use the recommended oil. Never substitute or mix oil brands.

## Break-in Period

1. Fill the fuel tank with gasoline. Always exercise extreme caution whenever handling gasoline. See page 15.
2. Check the oil level. Add the recommended oil as needed. Maintain the oil level in the proper range. See page 105.
3. Drive slowly at first. Select an open area that allows room to familiarize yourself with operation and handling.
4. Vary throttle positions. Do not operate at sustained idle.
5. Perform regular checks on fluid levels, controls and areas outlined on the daily pre-ride inspection checklist. See page 72.
6. Perform the following maintenance at the end of the break-in period.

Item	End of Break-In Remarks	See Page
Engine oil change	Perform break-in oil change	106
Oil pre-filter screen	Clean filter with oil change	107
Transmission oil	Perform break-in oil change	110
Valve clearance	See your dealer for inspection and adjustment	--

# Operation

## Pre-Ride Inspection

Failure to inspect and verify that the ATV is in safe operating condition before operating increases the risk of an accident. Always inspect the ATV before each use to make sure it's in safe operating condition.

<b>Pre-Ride Checklist</b>		
<b>Item</b>	<b>Remarks</b>	<b>Page</b>
Brake system / lever travel	Ensure proper operation	125, 129
Front suspension	Inspect, lubricate if necessary	102
Rear suspension	Inspect, lubricate if necessary	102
Steering	Ensure free operation, lubricate if necessary	130, 132
Tires	Check condition and pressure	139
Wheels / fasteners	Inspect, ensure fastener tightness; check that axle nuts are secured by cotter pins	141, 141
Fuel and oil	Check and fill as needed	15, 65

## Pre-Ride Inspection

<b>Pre-Ride Checklist</b>		
<b>Item</b>	<b>Remarks</b>	<b>Page</b>
Throttle	Check for proper operation	47, 60, 61
Engine stop switch	Check for proper function	58
Daytime running lights (if equipped)	Check for proper operation	143
Brakelight	Check for proper operation	142
Air filter, pre-filter	Inspect, clean or replace	136
Drive chain	Check condition and slack; refer to drive chain adjustment	133
Frame nuts, bolts, fasteners	Inspect, ensure tightness	--
Loose or damaged components	Visually inspect for any damaged components or loose fasteners	--
Riding gear	Wear helmet, goggles, protective clothing	10

# Operation

## Safe Operation Practices

1. Complete the recommended safety training before operating this vehicle. See page 8.
2. Do not allow anyone under 6 years of age to operate this vehicle.
3. Never carry a passenger on this ATV.
4. Engine exhaust fumes are poisonous. Never start the engine or let it run in an enclosed area.
5. Operate this vehicle off-road only. Never operate the vehicle on pavement or on any public street, road or highway, including dirt and gravel roads.
6. Never exceed the maximum weight capacity of the vehicle. When determining the weight you are adding to the vehicle, include the weight of the operator, accessories, loads on the racks (if equipped) and the load on the trailer tongue (if equipped). The combined weight of these items must not exceed the maximum weight capacity.

### Safe Operation Practices

7. Drive in a manner appropriate for your skills and operating conditions. Never operate at excessive speeds. Never attempt wheelies, jumps, or other stunts. Never remove your hands from the handlebars while operating, and always keep both feet on the footrests.
8. Never consume alcohol or drugs before or while operating an ATV.
9. Always use the size and type of tires specified for your vehicle. Always maintain proper tire pressure.
10. Never operate a damaged ATV. After any overturn or accident, have a qualified service dealer inspect the entire machine for possible damage.
11. Never operate the ATV on a frozen body of water.
12. Do not touch hot exhaust system components. Always keep combustible materials away from the exhaust system.
13. Always remove the ignition key when the vehicle is not in use to prevent unauthorized use.

# Operation

## Starting the Engine

**NOTICE:** Operating the ATV immediately after starting could cause engine damage. Allow the engine to warm up for several minutes before operating.

1. Lock the parking brake.
2. Turn the fuel valve on.
3. Sit on the vehicle.
4. Attach the tether strap to the ATV and to your wrist.
5. If the engine is cold, use full choke by pushing the choke lever all the way to the left. Do not use the choke when starting a warm engine.

**Tip:** The choke is fully on when the lever is pushed completely to the left. The choke is off when the lever is pushed completely to the right. The choke can be adjusted gradually, depending on how much choke is needed for starting.

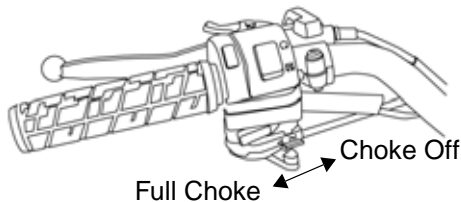

## Starting the Engine

6. Push the engine stop switch up to the ON position.
7. Turn the ignition key to ON.
8. Squeeze the rear brake lever and press the start button. The rear brake lever must be engaged for the engine to start.
9. Do not press the throttle while starting the engine. Activate the starter for a maximum of five seconds, releasing the button when the engine starts. If it doesn't start, release the starter, wait five seconds, then activate for another five seconds. Repeat until the engine starts.
10. If the engine slows or stops, position the choke lever half way to allow proper engine warm up. Vary the RPM slightly with the throttle to aid in warm up.
11. When the engine idles smoothly, push the choke lever completely to the right.



# Operation

## Stopping the Engine

1. Release the throttle completely.
2. Apply the brakes until the vehicle stops moving.
3. Stop the engine. There are three ways to stop the engine:
  - Turn the key off.
  - Push the engine stop switch down.
  - Pull the tether strap off the ATV.
4. Lock the parking brake.
5. To avoid draining the battery, always turn the key to the OFF position when the engine is not running.

## Driving Procedure

1. Wear a helmet and eye protection.
2. Sit upright with both feet on the footrests and both hands on the handlebars.
3. Lock the parking brake.
4. Start the engine and allow it to warm up.
5. Check your surroundings and determine your path of travel.
6. Slowly squeeze and release the left brake lever to unlock the parking brake.
7. Slowly press the throttle with your right thumb and begin driving.
8. Drive slowly at first. Practice turning and using the throttle and brakes on level surfaces.

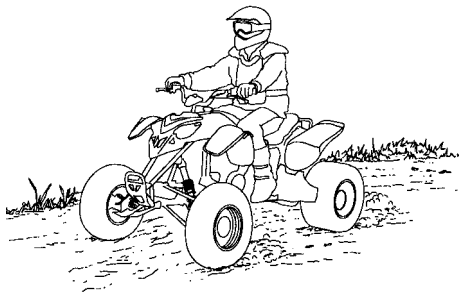

## Operation

### Making Turns

Your ATV is equipped with a solid rear axle, which drives both rear wheels equally at all times. This means that the wheel on the outside of the turn must travel a greater distance than the inside wheel when turning, and the inside tire must slip traction slightly.

To turn, steer in the direction of the turn, leaning your upper body to the inside of the turn while supporting your weight on the outer footrest. This technique alters the balance of traction between the rear wheels, allowing the turn to be made smoothly.

Practice making turns at slow speeds.

**WARNING!** Turning improperly can result in vehicle overturn. Never turn abruptly or at sharp angles. Never turn at high speeds.

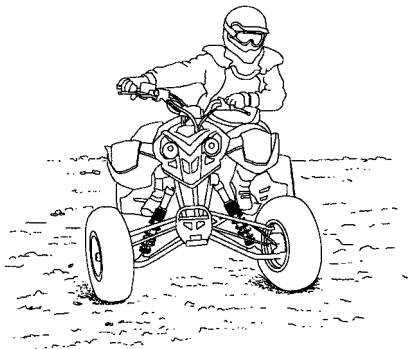

## Driving Over Obstacles

Follow these precautions when operating over obstacles:

1. Always check for obstacles before operating in a new area.
2. Look ahead and learn to read the terrain. Be constantly alert for hazards such as logs, rocks and low hanging branches.
3. Travel slowly and use extra caution when operating on unfamiliar terrain. Not all obstacles are immediately visible.
4. Never attempt to operate over large obstacles, such as rocks or fallen trees.

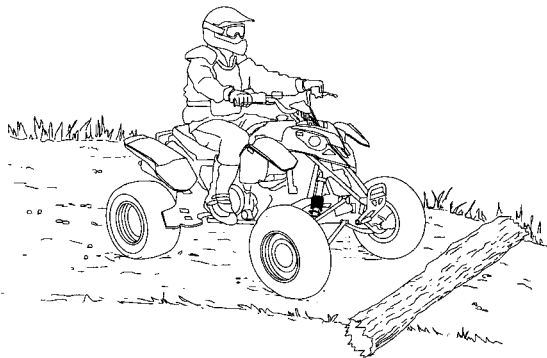

## Operation

### Driving Uphill

Braking and handling are greatly affected when operating in hilly terrain. Improper procedure could cause loss of control or overturn. Whenever traveling uphill, follow these precautions:

1. Drive straight uphill.
2. Avoid steep hills ( $15^{\circ}$  maximum).
3. Always check the terrain carefully before ascending any hill.
4. Never climb hills with excessively slippery or loose surfaces.

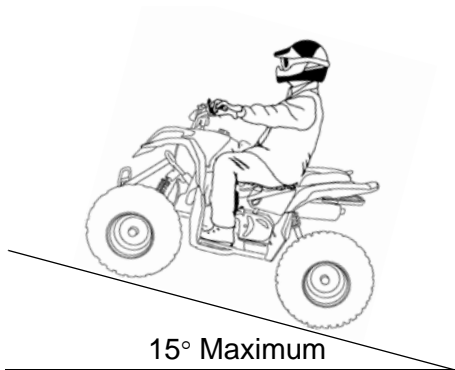

### Driving Uphill

5. Keep both feet on the footrests.
6. Shift body weight uphill.
7. Proceed at a steady rate of speed and throttle opening. Opening the throttle suddenly could cause the ATV to flip over backwards.
8. Never go over the top of any hill at high speed. An obstacle, a sharp drop, or another vehicle or person could be on the other side of the hill.
9. Remain alert and be prepared to take emergency action. This may include quick dismounting of the vehicle.

# Operation

## Driving on a Sidehill (Sidehilling)

Driving on a sidehill is not recommended. Improper procedure could cause loss of control or overturn. Avoid crossing the side of any hill unless absolutely necessary.

If crossing a sidehill is *unavoidable*, follow these precautions:

1. Slow down.
2. Lean into the hill, transferring your upper body weight uphill while keeping your feet on the footrests.
3. If the vehicle begins to slide or tip, quickly turn the front wheel downhill, if possible, or dismount on the uphill side *immediately!*

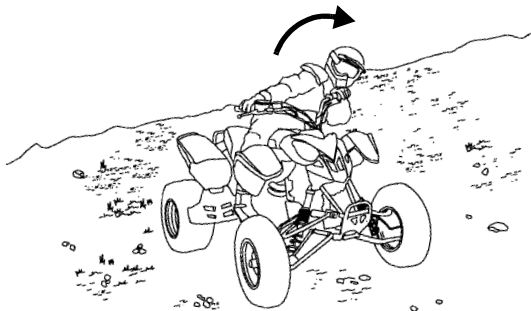

### Driving Downhill

When driving downhill, follow these precautions:

1. Avoid steep hills ( $15^{\circ}$  maximum).
2. Shift body weight uphill. Transfer your weight to the rear of the vehicle.
3. Drive straight downhill.
4. Slow down. Excessive speed when traveling downhill can cause loss of control.
5. Apply the front and rear brakes at the same time, and very slightly, to aid in slowing.

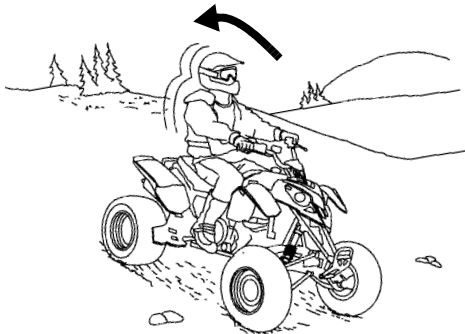



## **Operation**

### **Turning Around on a Hill**

If the vehicle stalls while climbing a hill, never back it down the hill! Use the K-turn to turn around.

1. Stop the vehicle and lock the parking brake while keeping body weight uphill.
2. Shut off the engine.
3. Dismount on the uphill side of the vehicle, or on the left if the vehicle is pointing straight uphill.

## Turning Around on a Hill

4. Staying uphill of the ATV, turn the handlebars full left.
5. While holding the brake, release the parking brake lock and slowly release the brake, allowing the ATV to roll around to your right until it's pointing across the hill or slightly downward.
6. Lock the parking brake and remount the ATV from the uphill side, keeping body weight uphill.
7. Restart the engine.
8. Squeeze the rear brake lever.
9. Release the parking brake and drive slowly, controlling speed with the rear brake, until the ATV is on more level ground.

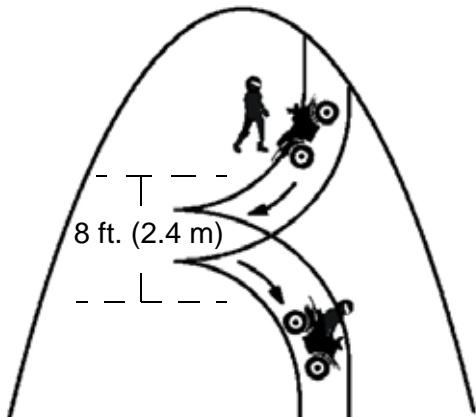

# Operation

## Parking on a Hill or Incline

Avoid parking on a hill or incline if possible. If it's unavoidable, follow these precautions:

1. Stop the engine.
2. Lock the parking brake.
3. Always block the rear wheels on the downhill side as shown in the illustration.
4. Turn the fuel valve off.

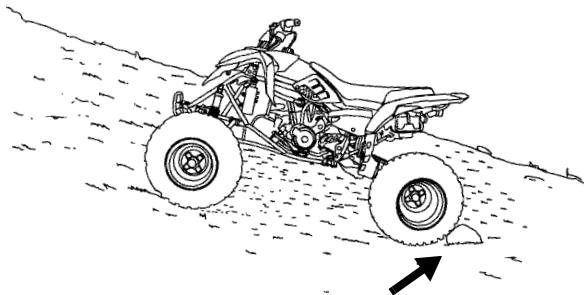

## Driving on Slippery Surfaces

Whenever riding on slippery surfaces such as wet trails or loose gravel, or during freezing weather, follow these precautions:

1. Do not operate on excessively rough, slippery or loose terrain.
2. Slow down when entering slippery areas.
3. Maintain a high level of alertness, reading the trail and avoiding quick, sharp turns, which can cause skids.
4. Never apply the brakes during a skid. Correct a skid by turning the handlebars in the direction of the skid and shifting your body weight forward.

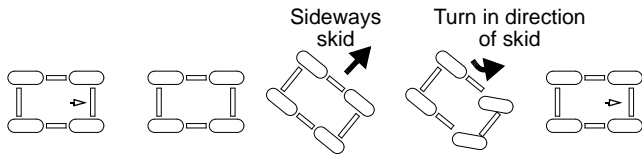
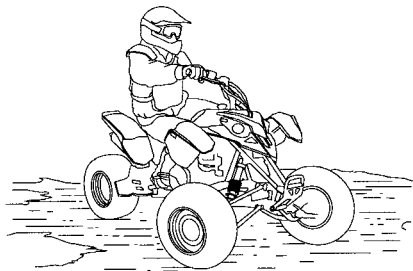

## Operation

### Driving Through Water

Your ATV can safely operate through shallow water. The recommended maximum depth for your ATV is below the bottom of the footrests. Follow these precautions when operating through water:

1. Determine water depth and current before entering water.
2. If crossing a stream, choose a crossing where both banks have gradual inclines.
3. Avoid operating through deep or fast-flowing water.

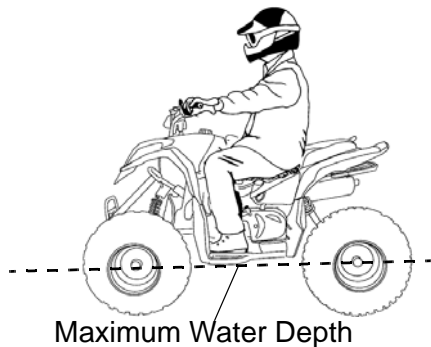

### Driving Through Water

4. After driving through water, dry the brakes by applying light pressure to the levers (while moving) until braking action is normal. If you do not perform this procedure, your brakes may be ineffective.

**NOTICE:** Serious engine damage can result if the vehicle is not thoroughly inspected after operating in water deeper than the footrest level. As soon as possible, perform the inspections and maintenance services outlined in the periodic maintenance chart beginning on page 94. Engine oil, gearcase oil, front and rear gearcases (if equipped) and all grease fittings need special attention.

If the vehicle tips or overturns in water, or if the engine stops during or after operating in water, restarting can result in serious engine damage. Transport the vehicle to your dealer for service before restarting the engine. If this is not possible, follow the vehicle immersion inspection and drying procedures outlined on page 114, then see your dealer for service at the first opportunity.

# **Emission Control Systems**

## **Noise Emission Control System**

Do not modify the engine, intake or exhaust components, as doing so may affect compliance with U.S.A. EPA noise control requirements (40 CFR 205) and local noise level requirements.

## **Operation on Public Lands in the U.S.A.**

Your POLARIS vehicle has a spark arrester that was tested and qualified to be in accordance with the USFS standard 5100-1c. Federal law requires that this spark arrester be installed and functional when the vehicle is operated on public lands.

Operation of off-road vehicles on public lands in the U.S.A. is regulated by 43 CFR 420. Violations are subject to monetary penalties. Federal regulations can be viewed online at [www.gpoaccess.gov/ecfr/](http://www.gpoaccess.gov/ecfr/).

## **Crankcase Emission Control System**

This engine is equipped with a closed crankcase system. Blow-by gases are forced back to the combustion chamber by the intake system. All exhaust gases exit through the exhaust system.

# Emission Control Systems

## Exhaust Emission Control System

The emissions from the exhaust of this vehicle are controlled by engine design, including factory-set fuel delivery and ignition. The engine and related components must be maintained at POLARIS specifications to achieve optimal performance.

Engine idle speed is the only adjustment POLARIS recommends that the operator perform. Any other adjustments should be performed by an authorized POLARIS dealer.

The emissions label is located on the clutch cover or engine case near the clutch box.

The installation of devices that effectively increase exhaust emissions beyond their legal limits will void all manufacturer warranties and may violate laws governing the registration and operation of this vehicle.

## Electromagnetic Interference

This spark ignition system complies with Canadian ICES-002.

This vehicle complies with the EMC requirements of European directives 97/24/EC and 2004/108/EC.

**Non-ionizing Radiation:** This vehicle emits some electromagnetic energy. People with active or non-active implantable medical devices (such as heart monitoring or controlling devices) should review the limitations of their device and the applicable electromagnetic standards and directives that apply to this vehicle.



# **Maintenance**

## **Periodic Maintenance Chart**

To help you perform routine maintenance, a tool kit is provided in the storage compartment under the seat.

Maintenance intervals in the following charts are based upon average riding conditions and an average vehicle speed of approximately 10 miles per hour. Vehicles subjected to severe use must be inspected and serviced more frequently. Record maintenance and service in the Maintenance Log beginning on page 181.

## Periodic Maintenance Chart

Inspect, clean, lubricate, adjust and replace parts as necessary. When inspection reveals the need for replacement parts, use genuine POLARIS parts available from your POLARIS dealer.

Service and adjustments are critical. If you're not familiar with safe service and adjustment procedures, have a qualified dealer perform these operations.

### Severe Use Definition

- Frequent immersion in mud, water or sand
- Racing or race-style high RPM use
- Prolonged low speed, heavy load operation
- Extended idle
- Short trip cold weather operation

# Maintenance

## Periodic Maintenance Chart

### **WARNING**

Improperly performing the procedures marked with a ■ could result in component failure and cause an accident, which may result in serious injury or death. Always have an authorized POLARIS dealer perform these services.

### **Maintenance Chart Key**

► Perform these operations more often under severe use, such as in dirty or wet conditions, to purge water or dirt contamination from grease fittings and other critical components.

**E** Emission-related service (Failure to conduct this maintenance will not void the emissions warranty but may affect emissions.)

■ Dealer service item.

# Maintenance

## Periodic Maintenance Chart

Item		Maintenance Interval (whichever comes first)			Remarks	See Page
		Hours	Calendar	Miles (Km)		
■	Steering	--	Daily	--	Check each day before operating the vehicle. Make adjustments as needed. See the Pre-Ride Checklist.	72
	Front suspension	--	Daily	--		
	Rear suspension	--	Daily	--		
	Tires	--	Daily	--		
	Brake lever travel	--	Daily	--		
	Brake system	--	Daily	--		
	Wheels/fasteners	--	Daily	--		
	Frame fasteners	--	Daily	--		
	Engine oil level	--	Daily	--		
E	Air filter, pre-filter & main element	--	Daily	--	Inspect; clean often; replace as needed	136
	Air box sediment tube	--	Daily	--	Drain deposits when visible	--
	Daytime running lights/tail lamp	--	Daily	--	Check operation; apply dielectric grease if replacing	142 143

# Maintenance

## Periodic Maintenance Chart

Item		Maintenance Interval (whichever comes first)			Remarks	See Page
		Hours	Calendar	Miles (Km)		
	Drive chain	--	Daily	--	Inspect daily; adjust and lubricate if needed	133
	CVT housing (if equipped)	--	Weekly	--	Drain water as needed, check often if operating in wet conditions	117
	Break-in Maintenance	After first 10 hours of operation			Perform break-in maintenance	70
▶■	Brake lever travel/brake freeplay	10	Monthly	100 (160)	Inspect regularly	125 129
E	Spark plug	10	Monthly	100 (160)	Clean; check condition; adjust gap; replace as needed	112
	Idle speed	10	Monthly	100 (160)	Check; adjust as needed	121
■E	Choke	10	Monthly	100 (160)	Check for proper operation; see your dealer for adjustments	

▶ Perform these procedures more often for vehicles subjected to severe use.

E Emission-Related Service

■ Have an authorized POLARIS dealer perform these services.

# Maintenance

## Periodic Maintenance Chart

Item		Maintenance Interval (whichever comes first)			Remarks	See Page
		Hours	Calendar	Miles (Km)		
	Battery	20	Monthly	200 (320)	Check terminals; clean; test	144
▶	Engine oil change	30	6 M	300 (480)	Drain and change the oil	106
▶	Transmission oil	40	12 M	400 (640)	Drain and change the oil	110
▶	Oil pre-filter screen	40	12 M	400 (640)	Clean filter at every oil change; clean annually if ATV is operated less than 10 hours	107
▶	General lubrication	50	3 M	500 (800)	Lubricate all fittings, pivots, cables, etc.	--
■E	Valve clearance	50	3 M	500 (800)	Check clearance; see your dealer for adjustments	--
	Carburetor float bowl	50	6 M	500 (800)	Drain bowl periodically and prior to storage	--
■E	Throttle cable/ETC switch	50	6 M	500 (800)	Inspect; adjust; lubricate; replace if necessary	--
■E	Choke cable	50	6 M	500 (800)	Inspect; adjust; lubricate; replace if necessary	--

# Maintenance

## Periodic Maintenance Chart

Item		Maintenance Interval (whichever comes first)			Remarks	See Page
		Hours	Calendar	Miles (Km)		
E	Carburetor air intake ducts/flange	50	6 M	500 (800)	Check for proper sealing/air leaks	--
■	Drive belt	50	6 M	500 (800)	See your POLARIS dealer	--
▶■	Brake pad wear	50	6 M	500 (800)	See your POLARIS dealer	--
■E	Fuel system	100	12 M	1000 (1600)	Check for leaks at tank cap, lines, fuel valve, filter, pump, carburetor; replace lines every two years	--
■E	Fuel filter	100	12 M	1000 (1600)	Change filter	109
▶	Engine mounts	100	12 M	1000 (1600)	Inspect	--
	Exhaust muffler/pipe	100	12 M	1000 (1600)	Inspect	--
■	Ignition timing	100	12 M	1000 (1600)	Inspect	--

▶ Perform these procedures more often for vehicles subjected to severe use.

E Emission-Related Service

■ Have an authorized POLARIS dealer perform these services.

# Maintenance

## Periodic Maintenance Chart

Item		Maintenance Interval (whichever comes first)			Remarks	See Page
		Hours	Calendar	Miles (Km)		
▶	Wiring	100	12 M	1000 (1600)	Inspect for wear, routing, security; apply dielectric grease to connectors subjected to water, mud, etc.	--
■	Clutches (drive and driven)	100	12 M	1000 (1600)	Inspect; clean; replace worn parts	--
■	Front wheel bearings	100	12 M	1000 (1600)	Inspect; replace as needed	--
	Spark arrester	300	36 M	3000 (4800)	Clean out	118
■	Toe adjustment	--			Inspect periodically; adjust when parts are replaced	130



# Maintenance

## Lubrication Guide

Item	Lube	Method
Engine Oil	POLARIS Synthetic Youth Oil or Synthetic SAE 40	See page 104.
Gearcase (Transmission) Oil Level	Premium AGL Synthetic Gearcase Lube	See page 110.
Drive Chain	POLARIS Chain Lube or SAE 80/90	See page 133.
▶ Front Suspension (A-Arm)	POLARIS All Season Premium Grease or grease conforming to NLGI No. 2	Inspect; tighten fasteners; grease (also after washing ATV or driving in water).

▶ Perform these procedures more often for vehicles subjected to severe use

## Lubrication Guide

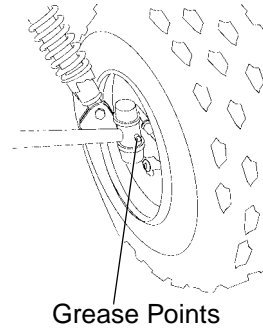
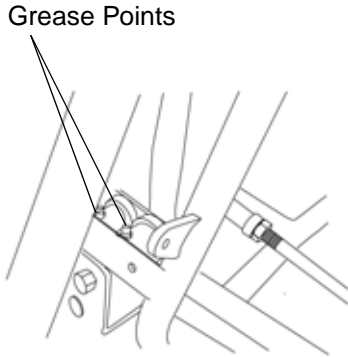

# Maintenance

## Engine Oil

### Oil Recommendations

Always check and change the engine oil at the intervals outlined in the Periodic Maintenance Chart beginning on page 94. Oil may need to be changed more frequently if POLARIS oil is not used. Do not use automotive oil. See page 158 for the part numbers of POLARIS products.

Under These Operating Conditions	Use This Recommended Oil
Outside air temperature is <i>above</i> 32° F/0° C	POLARIS Synthetic Youth Oil (or Synthetic SAE40)
Outside air temperature is <i>below</i> 32° F/0° C	Semi-Synthetic 20W-40

**NOTICE:** Mixing brands or using a non-recommended oil may cause serious engine damage. Always use the recommended oil. Never substitute or mix oil brands.

## Engine Oil Check

Maintain the oil level within the safe range on the dipstick. Do not overfill.

1. Position the vehicle on a level surface.
2. Remove the dipstick. Wipe it dry with a clean cloth.
3. Reinstall the dipstick completely.
4. Remove the dipstick and check the oil level.

**Tip:** A rising oil level between checks in cool weather driving can indicate contaminants such as gas or moisture collecting in the crankcase. If the oil level is over the full/safe mark, change the oil immediately.

5. Add the recommended oil as needed.
6. Reinstall the dipstick.

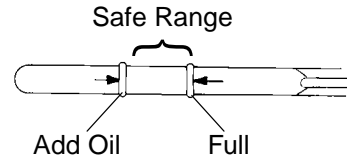
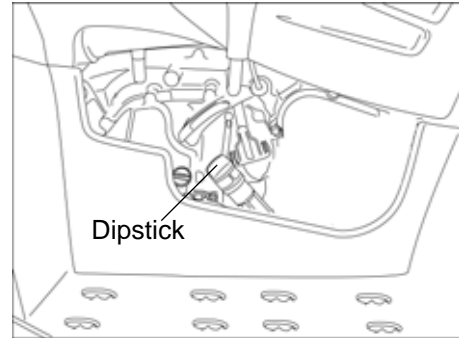

## **Maintenance**

### **Engine Oil Change**

1. Position the vehicle on a level surface.
2. Clean the area around the pre-filter plug.
3. Start the engine. Allow it to idle for two to three minutes.
4. Stop the engine.

**CAUTION!** Hot oil can cause burns to skin. Do not allow hot oil to contact skin.

## Engine Oil Change

5. Place a drain pan under the engine crankcase.
6. Remove the pre-filter plug. Allow the oil to drain completely.
7. Wash the oil pre-filter screen with solvent to remove debris. Allow the screen to air dry.
8. Clean the pre-filter plug. Install a new sealing washer on the plug. The sealing surfaces on the plug and crankcase should be clean and free of burrs, nicks or scratches.
9. Reassemble the pre-filter screen and spring to the pre-filter plug.

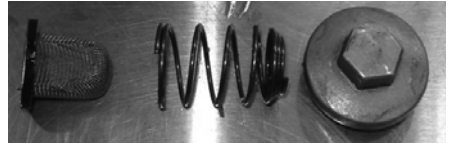

## **Maintenance**

### **Engine Oil Change**

10. Reinstall the pre-filter drain plug. Torque to 11 ft. lbs. (15 Nm).
11. Remove the dipstick. Add 29 oz. (850 ml) of the recommended oil. Do not overfill. See the specifications section beginning on page 156 for capacities.
12. Reinstall the dipstick.
13. Start the engine. Allow it to idle for one to two minutes.
14. Stop the engine and inspect for leaks.
15. Check the oil level. Add oil as needed to bring the level to the upper mark on the dipstick.
16. Dispose of used oil properly.

### Fuel Filter

The POLARIS ATV is equipped with an in-line fuel filter. This filter should be replaced by your dealer at the intervals recommended in the Periodic Maintenance Chart beginning on page 94. Do not attempt to clean the fuel filter.



# Maintenance

## Transmission Oil Check

The gearcase fill plug is located on the side of the gearcase on the right side of the ATV. Maintain the oil level at the bottom of the fill plug hole threads.

Always check and change the oil at the intervals outlined in the Periodic Maintenance Chart beginning on page 94. POLARIS recommends the use of AGL Synthetic Gearcase Lubricant. See page 158 for the part numbers of POLARIS products.

1. Position the vehicle on a level surface.
2. Remove the fill plug.
3. View the oil level through the fill hole.
4. If the level is low, add the recommended oil.
5. Reinstall the fill plug.

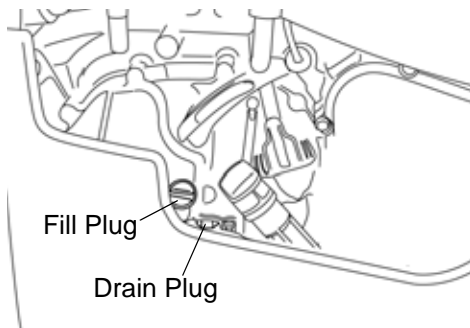

### Transmission Oil Change

1. Position the vehicle on a level surface.
2. Remove the fill plug.
3. Place a drain pan under the gearcase.
4. Remove the drain plug. Allow the oil to drain completely.
5. Clean and reinstall the drain plug. Torque to 14 ft. lbs. (19 Nm).
6. Add the recommended oil. Maintain the oil level at the bottom of the fill plug hole threads.
7. Reinstall the fill plug. Check for leaks.
8. Dispose of used oil properly.

<b>Gearcase Capacity</b>	
OUTLAW 50	11.8 oz. (350 ml)

# Maintenance

## Spark Plugs

Refer to the specifications section beginning on page 156 for spark plug and gap specifications.

**NOTICE:** Using non-recommended spark plugs can result in serious engine damage. Always use POLARIS-recommended spark plugs.

Spark plug condition is indicative of engine operation. The spark plug firing end condition should be read after the engine has been warmed up and the vehicle has been driven at higher speeds. Immediately check the spark plug for correct color.

**CAUTION!** A hot exhaust system and engine can cause burns. Wear protective gloves when removing a spark plug for inspection.

## Spark Plugs

### Normal Plug

The normal insulator tip is gray, tan or light brown. There will be few combustion deposits. The electrodes are not burned or eroded. This indicates the proper type and heat range for the engine and the service. The tip should not be white. A white insulator tip indicates overheating, caused by use of an improper spark plug or incorrect fuel system operation.

### Wet Fouled Plug

The wet fouled insulator tip is black. A damp oil film covers the firing end. There may be a carbon layer over the entire nose. Generally, the electrodes are not worn. General causes of fouling are excessive oil, use of non-recommended injection oil, improper use of the choke, or incorrect fuel system operation.

### Spark Plug Change

1. Remove the spark plug cap.
2. Using the special wrench provided in the tool pouch, rotate the spark plug counterclockwise to remove it.
3. Reverse the procedure for spark plug installation. Torque to 14 ft. lbs. (19 Nm).

## Maintenance

### Cylinder Head Torque

Have your dealer check the ATV cylinder head for proper torque at the first service, or after 25 hours.

### Vehicle Immersion

If the vehicle tips or overturns in water deeper than the footrest level, or if the engine stops during or after operating in water, restarting WILL result in serious engine damage. Transport the vehicle to your dealer for service before restarting the engine. If this is not possible, follow the vehicle immersion inspection and drying procedures outlined below. This procedure will allow *short-term operation only* to drive the ATV to a trailer or towing vehicle.

1. Move the ATV to dry land or at the very least, to water below the footrests.
2. Turn the fuel valve off.
3. Check the air box for any water and dry it if water is present.
4. Remove the spark plug.

## Maintenance

### Vehicle Immersion

5. Loosen the carburetor drain screw.
6. Turn the engine over several times using the electric start.
7. Dry the spark plug and reinstall it, or replace it with a new plug.
8. Tighten the carburetor drain screw.
9. Turn the fuel valve on.
10. Attempt to start the engine. If necessary, repeat the drying procedure.
11. Take the ATV to your dealer for service as soon as possible, whether you succeed in starting it or not.
12. If water has been ingested into the transmission, follow the procedure on page 117 for drying the CVT.

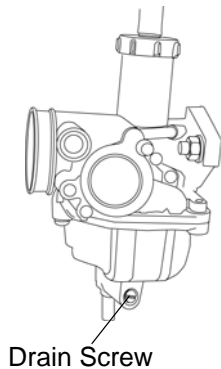

# Maintenance

## Constant Variable Transmission (CVT) System

### **WARNING**

Failure to comply with the instructions in this warning can result in severe injury or death.

Do not modify any component of the CVT system. Doing so may reduce its strength so that a failure may occur at a high speed. The CVT system has been precision balanced. Any modification will cause the system to be out of balance, creating vibration and additional loads on components.

The CVT system rotates at high speeds, creating large amounts of force on clutch components. Extensive engineering and testing has been conducted to ensure the safety of this product. However, as the owner, you have the following responsibilities to make sure this system remains safe:

- Always follow all recommended maintenance procedures. See your dealer as outlined in the owner's manual.
- This CVT system is intended for use on POLARIS products only. Do not install it in any other product.
- Always make sure the CVT housing is securely in place during operation.

### Constant Variable Transmission (CVT) System

#### CVT Drying

There may be some instances when water is accidentally ingested into the CVT system. Use the following instructions to dry it out before operating. The drain plug is located on the bottom of the CVT cover.

1. Remove the drain plug. Allow the water to drain. Reinstall the drain plug.
2. Start the engine. Apply varying throttle for 10-15 seconds to expel the moisture and air-dry the belt and clutches. Do not hold the throttle wide open for more than 10 seconds.
3. Allow the engine RPM to settle to idle speed.
4. Test for belt slippage. If the belt slips, repeat the process.
5. Take the vehicle to your dealer for service as soon as possible.

**NOTICE:** Exposure to salt water will cause corrosion to metal components. If your vehicle is operated in salt water areas, rinse it off frequently with fresh water.



# Maintenance

## Spark Arrester

To remove accumulated carbon, clean the spark arrester at the intervals recommended in the Periodic Maintenance Chart beginning on page 94.

### **WARNING**

Failure to heed these warnings could result in serious injury or death.

- Do not perform service on the spark arrester while the system is hot. Allow components to cool sufficiently before proceeding.
- Wear eye protection and gloves.
- Never run the engine in an enclosed area. Exhaust contains poisonous carbon monoxide gas.

### Spark Arrester

1. Remove the three bolts and remove the arrester from the end of the muffler.
2. Use a non-synthetic brush to clean the arrester screen. A synthetic brush may melt if components are warm. If necessary, blow debris from the screen with compressed air.
3. Inspect the screen for wear and damage. Replace the arrester if damage is found.
4. Reinstall the arrester.
5. Torque the bolts to 7 ft. lbs. (9.5 Nm).

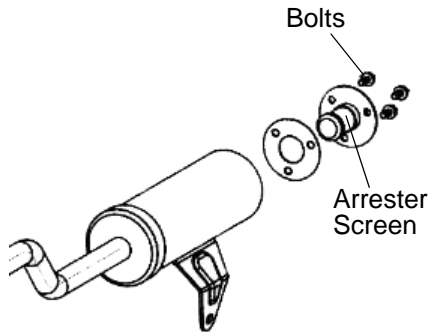

## **Maintenance**

### **Carburetor**

Your POLARIS ATV is calibrated at the factory for optimal performance at altitudes ranging from zero to 6,000 feet (1800 m) and temperatures of +40 degrees F. (4 degrees C.) or higher.

### Carburetor

If engine idle speed is too high the vehicle will creep. If idle speed is too low the engine will stall. To adjust idle speed, do the following:

1. Lock the parking brake.
2. Start the engine.
3. Allow the engine to warm up for approximately five minutes.
4. Adjust the carburetor idle screw either in or out until the desired idle speed is reached. Turning the screw in (clockwise) will increase idle speed. Turning the screw out (counter-clockwise) will decrease idle speed.

**Tip:** If using an RPM gauge, the factory idle speed setting for 50cc models is 1500 +/- 100 RPM.

## Maintenance

### Speed Control System

Per ANSI / SVIA-1-2001 (sec. 6.1.3) AS DELIVERED TO THE CONSUMER, the speed of youth models is restricted to *under* 10 MPH for the 50cc models and *under* 15 MPH for the 90cc models.

*The dealer CANNOT, under any circumstances, either prior to the sale or later, even at the consumer's request, remove or adjust any speed limiting devices.*

Your POLARIS ATV has an adjustable throttle limiting screw. Speed limiting devices may be adjusted/removed *only by consumers* when they determine that their child is capable of handling the additional speed.

Per ANSI / SVIA-1-2001 (sec. 6.2) the *unrestricted* top speed is less than 15 MPH for the 50cc models and less than 30 MPH for the 90cc models.

## Speed Control System

### Throttle Stop Speed Control System

Use the following procedure to control how far the throttle opens.

1. Loosen the jam nut.
2. Turn the screw inward to reduce speed or outward to increase speed.
3. Tighten the jam nut after adjusting.

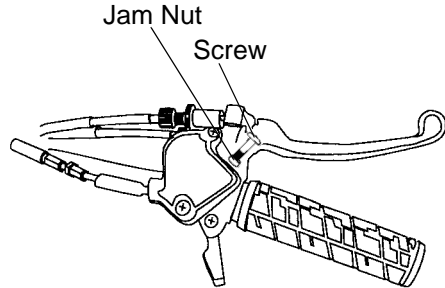

# Maintenance

## Throttle Cable Adjustment

Always check the throttle for smooth operation before riding. Periodically check the throttle freeplay. It should be kept between 1/16" and 1/8" (1.5 - 3.2 mm). If adjustment is required, turn the adjustment nut until the freeplay falls in to the acceptable limit.

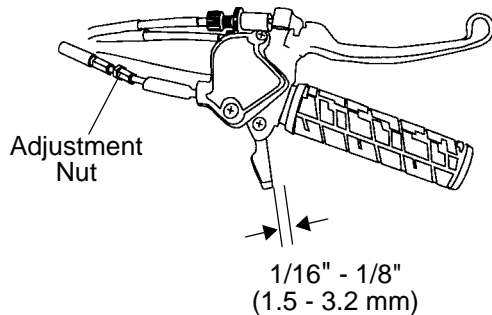

## Brake Freeplay

Check (measure) the freeplay of the front and rear brakes at the intervals recommended in the Periodic Maintenance Chart beginning on page 94. If the freeplay isn't at specification, adjust the freeplay as outlined on the following pages.

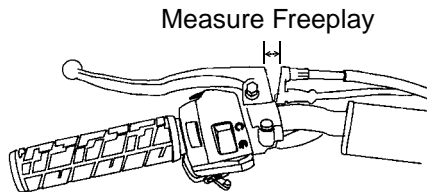

<b>Brake Freeplay Specifications</b>		
<b>Model</b>	<b>Front Brake</b>	<b>Rear Brake</b>
OUTLAW 50	.08"-.12" (2-3 mm)	.08"-.12" (2-3 mm)



# Maintenance

## Brake Freeplay

### Front Brake Adjustment

1. Position the vehicle on a level surface.
2. Elevate the front of the vehicle by placing a suitable stand under the frame. The front tires should be slightly off the ground.
3. While rotating the *left* front wheel, tighten the *upper* front brake adjuster nut on the right-hand control.
4. When you begin to feel a slight drag in wheel rotation, loosen the adjuster nut one full turn.

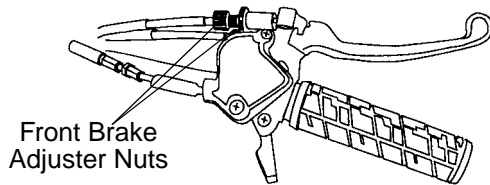

### Brake Freeplay

#### Front Brake Adjustment

5. While rotating the *right* front wheel, tighten the *lower* front brake adjuster nut on the right-hand control.
6. When you begin to feel a slight drag in wheel rotation, loosen the adjuster nut one full turn.
7. Verify that the right-hand brake functions correctly.
8. Verify that brake lever freeplay is at specification. See page 125.
9. Carefully lower the vehicle to the ground.

# Maintenance

## Brake Freeplay

### Rear Brake Adjustment

1. Position the vehicle on a level surface.
2. Elevate the rear of the vehicle by placing a suitable stand under the frame. The rear tires should be slightly off the ground.
3. While rotating the rear wheels, tighten the rear brake wing nut at the rear brake drum.
4. When you begin to feel a slight drag in wheel rotation, loosen the wing nut one full turn.
5. Verify that the left hand brake functions correctly.
6. Verify that brake lever freeplay is at specification. See page 125.
7. Carefully lower the vehicle to the ground.

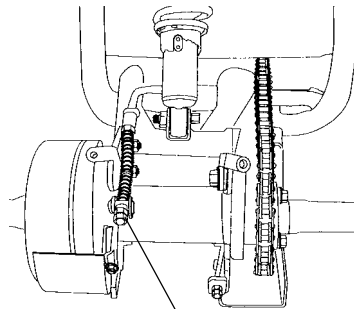

Rear Brake  
Wing Nut

## Brake Lever Travel

Check brake lever travel at the intervals recommended in the Periodic Maintenance Chart beginning on page 94. When freeplay specifications can no longer be obtained through adjustment as outlined on the preceding pages, use the following information to determine when to service the brakes.

Service the brakes when brake lever travel reaches the total lever travel measurement listed in the table below. Always service the brakes when there is no longer sufficient stopping ability at the specified lever travel setting.

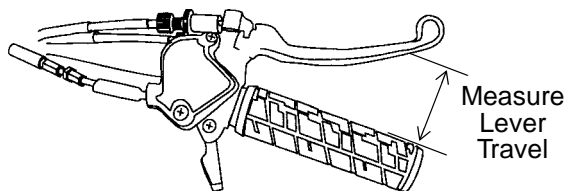

Component	Total Lever Travel
Front brake lever	1 3/4" (45 mm)
Rear brake lever	2 1/2" (65 mm)

# Maintenance

## Toe Alignment

Use the following procedure to check the toe alignment of the vehicle. The recommended toe alignment is 1/8" to 1/4" (3-6 mm) toe out.

**WARNING!** Severe injury or death can result from improper toe alignment and adjustment. Do not attempt to adjust tie rod alignment. All tie rod adjustments should be performed by an authorized POLARIS dealer.

1. Position the vehicle on a level surface.
2. Place the handlebars in a straight-ahead position.
3. Tie a length of string between two stands as shown in the illustration. Position the stands so that the string is flush with the side of the rear tire. If available, you may use a long straight-edge instead of string.

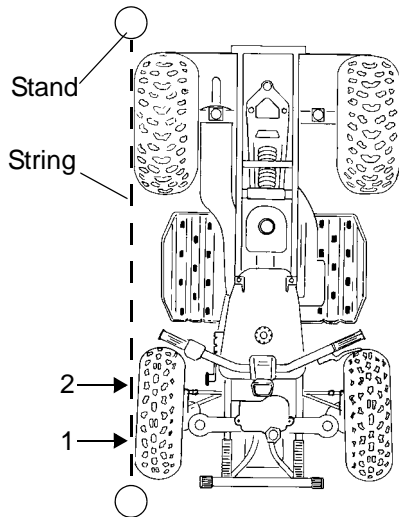

### Toe Alignment

4. Measure the distance from the string to the rim at the front (1) and rear (2) of the front rim. The rear measurement should be 1/16"-1/8" (2-3 mm) more than the front measurement on each side of the vehicle to obtain the recommended 1/8" to 1/4" (3-6 mm) toe out alignment.
5. Repeat the measurement procedure on the other side of the vehicle.
6. If you discover improper alignment, see your POLARIS dealer for service.

## Maintenance

### Steering Inspection

Check the steering assembly periodically for loose nuts and bolts. If any are found, have your dealer tighten them before operating the ATV.

### Camber and Caster

The camber and caster are non-adjustable.

### Shock Spring Adjustment

The rear shock absorber springs are adjustable to increase or decrease spring tension. Rotate the adjuster either clockwise or counter-clockwise to make adjustments.

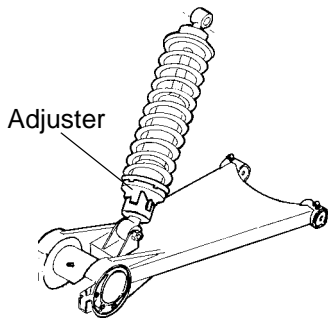

## Drive Chain

Lubricate the drive chain with POLARIS chain spray lube or an approved chain lube at the general lubrication interval specified in the Periodic Maintenance Chart beginning on page 94. Lubricate more often under severe use, such as in dirty or wet conditions. See page 158 for the part numbers of POLARIS products.

**NOTICE:** Washing the drive chain with a high pressure washer or gasoline can cause premature wear and drive chain failure. Don't use a high pressure washer or gasoline to clean the drive chain.

Adjusting or operating the ATV with improper rear drive chain slack can result in severe damage to the transmission and drive components. Always make sure the slack is within the stated specifications.



# Maintenance

## Drive Chain Slack

1. Check the amount of chain slack by moving the vehicle slightly forward to gain slack at the top side of the chain.
2. The chain should have 1/4"-1/2" (6-12 mm) deflection. If the chain needs adjustment, use the procedure on page 135.

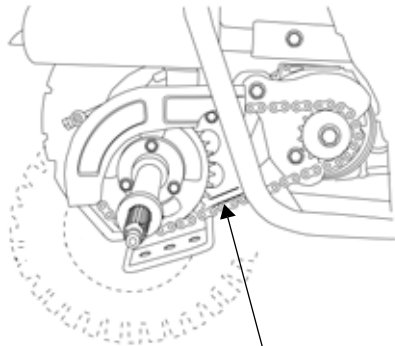

1/4"-1/2" (6-12 mm)  
Deflection

### Drive Chain Slack Adjustment

1. Loosen the four rear housing mount bolts.
2. Loosen the chain adjuster lock nut.
3. Turn the chain adjuster clockwise to 1/4"-1/2" (6-12 mm) deflection.
4. Tighten the chain adjuster lock nut to 18 ft. lbs. (25 Nm). Hold the adjuster stud securely while tightening the nut to avoid breaking the stud.
5. Tighten the four rear housing mount bolts to 43 ft. lbs. (60 Nm).

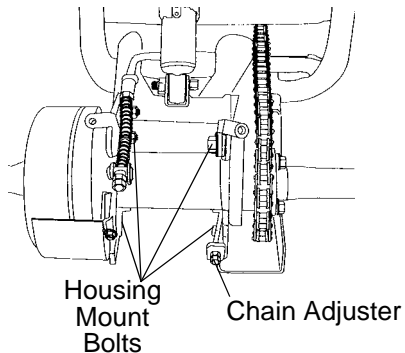

# Maintenance

## Air Filter

1. Remove the seat. See page 43.
2. Release the air box cover clips and remove the cover.
3. Remove the foam air filter. Wash the foam filter in warm soapy water, then rinse and let dry. If the filter is damaged, install a new foam filter.
4. Apply a commercially available foam filter lubricant to the foam filter.

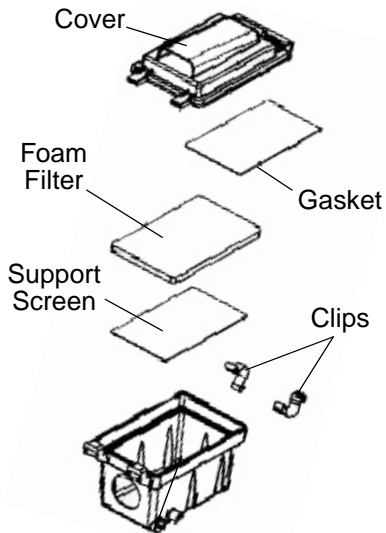

### Air Filter

5. Clean away any oil or sediments in the air box.
6. Reinstall the filter and air box cover. Secure the clips.
7. Reinstall the seat.

**NOTICE:** Never operate the ATV with the filter element removed. Dirt will enter the engine causing rapid wear and severe damage to the engine.

# Maintenance

## Handlebar Adjustment

### **⚠ WARNING**

Improper adjustment of the handlebars or incorrect torquing of the adjuster block tightening bolts can cause limited steering or loosening of the handlebars, resulting in loss of control and possible serious personal injury or death. Follow the adjustment procedures exactly, or see your POLARIS dealer for service.

The handlebars can be adjusted for rider preference.

1. Remove the pod to access the handlebar bolts.  
Loosen the four bolts.
2. Adjust the handlebar to the desired height. Be sure the handlebars do not hit the gas tank or any other part of the vehicle when turned fully to the left or right.
3. Lightly tighten each bolt equally to prevent uneven gaps in the block. Torque the bolts to 7.3 ft. lbs. (10 Nm).

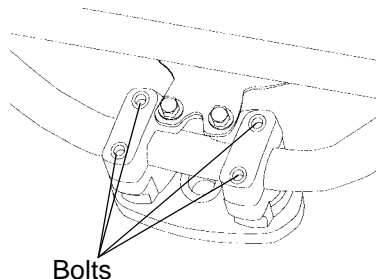

## Tires

### **WARNING**

Operating your ATV with worn tires, improperly inflated tires, non-standard tires or improperly installed tires will affect vehicle handling and could cause an accident resulting in serious injury or death. Always follow all tire maintenance procedures as outlined in this manual and on the labels on the vehicle. Always use original equipment size and type when replacing tires.

## Maintenance

### Tire Tread Depth

Always replace tires when tread depth is worn to 1/8" (3 mm) or less.

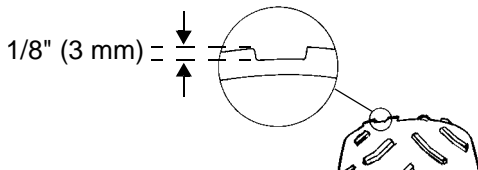

### Wheel Removal

1. Stop the engine and lock the parking brake.
2. Loosen the wheel bolts slightly.
3. Elevate the side of the vehicle by placing a suitable stand under the footrest frame.
4. Remove the wheel bolts and remove the wheel.

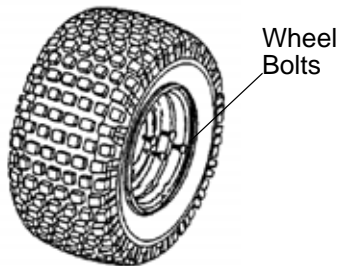

### Wheel Installation

1. Lock the parking brake.
2. Place the wheel in the correct position on the wheel hub. Be sure the valve stem is toward the outside and rotation arrows on the tire point toward forward rotation.
3. Install the wheel bolts and finger tighten them.
4. Lower the vehicle to the ground.
5. Securely tighten the bolts to 22 ft. lbs. (30 Nm).

### Axle and Wheel Nuts

All nuts with a cotter pin installed must be service by an authorized POLARIS dealer.

### Wheel Hub Tightening

Front wheel bearing tightness and spindle nut retention are critical component operations. All service must be performed by your authorized POLARIS dealer.



## Maintenance

### Tail Light Lamp Replacement

If the brakelight doesn't work, the lamp may need to be replaced.

1. Remove the two screws securing the lens cover. Remove the lens cover.
2. Remove the lamp and replace it with a new recommended lamp.
3. Test the light for proper operation.
4. Reinstall the lens cover.

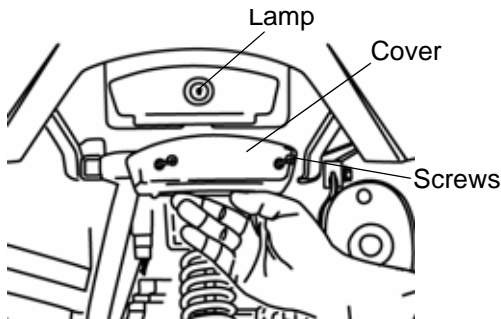

### Daytime Running Lights Lamp Replacement

If the daytime running lights do not operate, replace the lamps. POLARIS recommends that you install replacement lamps obtained from your authorized POLARIS dealer.

1. Disconnect the lights from the harness.
2. Remove the rubber cover from the back of the light assembly.
3. Press the lamp retainer inward and turn it counter-clockwise to remove it. Note the position of the lamp positioning tab, then carefully pull the lamp out.
4. Install the new lamp. Make sure the filament is horizontal.
5. Reinstall the lamp retainer. Press the retainer inward and turn it clockwise about 1/4 turn.
6. Start the engine to make sure the lights come on. If the lights do not operate, see your POLARIS dealer for service.
7. Reinstall the rubber cover, and reconnect the lights to the harness.

# Maintenance

## Battery

### **WARNING**

Improperly connecting or disconnecting battery cables can result in an explosion and cause serious injury or death. When removing the battery, always disconnect the negative (black) cable first. When reinstalling the battery, always connect the negative (black) cable last.

The battery in your POLARIS ATV is a sealed battery. The sealing strip cannot be removed. Never add water to this type of battery.

Keep the battery terminals and connections free of corrosion. If cleaning is necessary, remove the corrosion with a stiff wire brush. Wash with a solution of one tablespoon baking soda and one cup water. Rinse well with tap water and dry off with clean shop towels. Coat the terminals with dielectric grease or petroleum jelly to reduce oxidation and excessive power consumption.

## Battery

### Battery Removal

1. Remove the three bolts securing the battery mounting bracket to the vehicle.
2. Remove the mounting bracket and battery.
3. Disconnect the black (negative) battery cable first. Disconnect the red (positive) battery cable last.
4. Remove the battery terminal covers.
5. Loosen the two nuts securing the battery plate to the top of the battery. Remove the plate.
6. Lift the battery out of the mounting bracket.

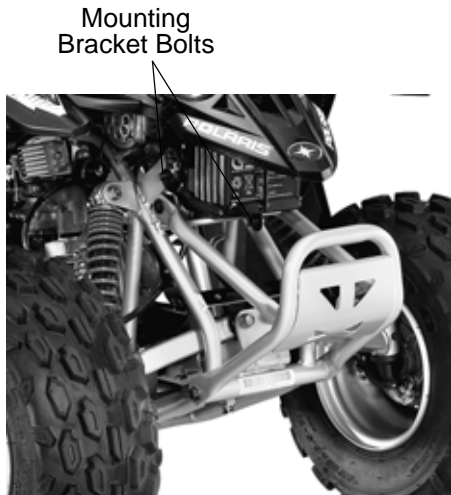

# Maintenance

## Battery

### Battery Installation

Always install a fully charged battery. Using a new battery that has not been fully charged can damage the battery and result in a shorter life. It can also hinder vehicle performance. If recharging is necessary, use a .5 amp battery charger.

1. Place the fully charged battery in the mounting bracket. Reinstall the battery plate and tighten the two nuts securely to retain the battery in the mounting bracket.
2. Coat the terminals with dielectric grease or petroleum jelly.
3. Install the terminal covers over the positive and negative battery terminals.
4. Connect and tighten the red (+) cable first. Connect and tighten the black (-) cable last. Torque the battery terminal bolts to 3.5 ft. lbs. (4.7 Nm).
5. Install the mounting bracket and battery to the vehicle. Tighten the three bolts.
6. Verify that battery cables are properly routed.

## Battery

### Battery Storage

Whenever the vehicle is not used for a period of three months or more, remove the battery from the vehicle, ensure that it's fully charged, and store it out of the sun in a cool, dry place. Check battery voltage each month during storage. Recharge as needed to maintain a full charge.

## Cleaning

Keeping your ATV clean will not only improve its appearance but it can also extend the life of various components.

**NOTICE:** High water pressure may damage components. POLARIS recommends washing the vehicle by hand or with a garden hose, using mild soap.

Certain products, including insect repellents and chemicals, will damage plastic surfaces. Do not allow these types of products to contact the vehicle.

# Maintenance

## Cleaning

### Washing the ATV

The best and safest way to clean your POLARIS vehicle is with a garden hose and a pail of mild soap and water.

1. Use a professional-type washing cloth, cleaning the upper body first and the lower parts last.
2. Rinse with clean water frequently.
3. Dry surfaces with a chamois to prevent water spots.

### Washing Tips

- Avoid the use of harsh cleaners, which can scratch the finish.
- Do not use a power washer to clean the vehicle.
- Do not use medium to heavy duty compounds on the finish.
- Always use clean cloths and pads for cleaning and polishing. Old or reused cloths and pads may contain dirt particles that will scratch the finish.

## Cleaning

### Washing the ATV

If a high pressure water system is used for cleaning (not recommended), exercise extreme caution. The water may damage components and could remove paint and decals. Avoid directing the water stream at the following items:

- Wheel bearings
- Radiator
- Transmission seals
- Brakes
- Cab and body panels
- Labels and decals
- Electrical components and wiring

If warning and safety labels are damaged, contact your POLARIS dealer for free replacement.

Grease all zerk fittings immediately after washing. Allow the engine to run for a while to evaporate any water that may have entered the engine or exhaust system.



## **Maintenance**

### **Polishing**

POLARIS recommends the use of common household aerosol furniture polish for polishing the finish on your POLARIS vehicle. Follow the instructions on the container.

#### **Polishing Tips**

- Avoid the use of automotive products, some of which can scratch the finish of your vehicle.
- Always use clean cloths and pads for cleaning and polishing. Old or reused cloths and pads may contain dirt particles that will scratch the finish.

## Storage

### Exterior

Make necessary repairs and clean the vehicle as recommended. See page 147.

### Battery Storage

Remove the battery from the vehicle, ensure that it's fully charged, and store it out of the sun in a cool, dry place. Check battery voltage each month during storage and recharge as needed to maintain a full charge.

# Maintenance

## Storage

### Stabilize the Fuel

POLARIS Carbon Clean is a fuel stabilizer and fuel system dryer. It cleans the fuel system, the combustion chamber and the exhaust ports. It also prevents bacterial growth and promotes better starting after the storage period.

1. Fill the fuel tank.
2. Add POLARIS Carbon Clean Fuel Treatment or POLARIS Fuel Stabilizer. Follow the instructions on the container for the recommended amount. Carbon clean will also reduce the possibility of bacterial growth in the fuel system.
3. Start the engine and allow it to run for 15-20 minutes so the stabilizer can disperse through the fuel in the tank and carburetor.
4. Stop the engine.
5. Turn the fuel valve off.
6. Drain the carburetor bowl.

## Storage

### Engine Oil

Change the oil. See page 106.

### Air Filter / Air Box

Inspect and clean (or replace) the pre-cleaner and air filter. Clean the air box. Drain the sediment tube.

### Fluid Levels

Inspect fluid levels. Change fluids as recommended in the Periodic Maintenance Chart beginning on page 94.

- Transmission Oil
- Engine Oil
- Brake Fluid

## **Maintenance**

### **Storage**

#### **Lubricate**

Inspect all cables and lubricate all areas of the vehicle as recommended in the Periodic Maintenance Chart beginning on page 94.

#### **Storage Area/Covers**

1. Make sure tire pressure is at specification.
2. Using suitable supports under the frame, raise the vehicle slightly so that the tires are not touching the ground.
3. Be sure the storage area is well ventilated.
4. Cover the vehicle with an appropriate cover. Do not use plastic or coated materials. They do not allow enough ventilation to prevent condensation, and may promote corrosion and oxidation.

### **Accessories**

POLARIS has a wide range of accessories available for your ATV. Please see your POLARIS dealer.

## Transporting the ATV

1. Stop the engine. Place the transmission in gear. Lock the parking brake.
2. Secure the fuel cap, oil cap and seat. Turn the fuel valve off.

**NOTICE:** Always tie the frame of the ATV to the transporting unit securely with suitable straps or rope. The rack, bumper or handlebars do not offer enough support for tie-down while transporting.

3. Attach the front tie strap to the frame tubes (not to the bumper tubes).
4. Wrap the rear tie strap around the grab bar.



Step 3



Step 3

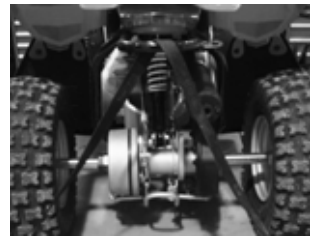

Step 4

## Specifications

<b>OUTLAW 50</b>	
Rider Capacity	1 Rider
Maximum Weight Capacity	90 lbs. (41 kg)
Displacement	49cc
Cooling	Air Cooled
Engine type	4-Stroke
Lubrication	Wet Sump
Oil Capacity	30 oz. (900 ml)
Fuel Capacity	1.2 gallons (4.5 liters)
Fuel Reserve Capacity	.22 gallons (.85 liters)
Starting	Electric with kick-start backup
Drive System	Automatic CVT
Final Drive	Chain
Front Suspension	Single control arm with 3" (7.6 cm) of travel
Rear Suspension	Spring over shock with 3" (7.6 cm) of travel
Front/Rear Brakes	Drum
Parking Brake	Mechanical Lock

## Specifications

<b>OUTLAW 50</b>	
Front Tires	16 x 6.5 - 7 (2 psi/13.8 kPa)
Rear Tires	16 x 8 - 7 (2 psi/13.8 kPa)
Dry Weight	210 lbs. (95.3 kg)
Length/Width/Height	48" (122 cm) / 31.5" (80 cm) / 28" (71 cm)
Wheel Base	33" (84 cm)
Ground Clearance	4" (10 cm)
Brake Light	Standard
Daytime Running Lights	Standard



## POLARIS Products

Part Number	Description
<b>Engine Lubricant</b>	
2876248	Synthetic Youth Oil (qt/.95 l)
2876249	Synthetic Youth Oil (gal/3.8 l)
2872175	Semi-Synthetic 20W-40 Oil (qt/.95 l)
2872176	Semi-Synthetic 20W-40 Oil (gal/3.8 l)
2870791	Fogging Oil, Aerosol
<b>Gearcase / Transmission Lubricants</b>	
2873602	Premium AGL Synthetic Gearcase Lubricant (qt/.95 l)
2872348	Chain Lube, Aerosol

## POLARIS Products

<b>Part Number</b>	<b>Description</b>
<b>Grease</b>	
2871322	All Season Premium Grease (3 oz./89 ml)
2871423	All Season Premium Grease (14 oz./414 ml)
<b>Miscellaneous Additives</b>	
2871326	Carbon Clean Plus

# Troubleshooting

See your POLARIS dealer if you're unable to identify solutions using the following charts.

## Engine Turns Over, Fails to Start

Possible Cause	Solution
Out of fuel	Turn the fuel valve to reserve, refuel
Clogged fuel valve or filter	Inspect and clean or replace
Water is present in fuel	Drain the fuel system and refuel
Fuel valve is turned off	Turn the fuel valve on
Old or non-recommended fuel	Replace with new fuel
Fouled or defective spark plug(s)	Inspect plug(s), replace if necessary
No spark to spark plug	Inspect plug(s), verify stop switch is on
Crankcase filled with water or fuel	Immediately see your POLARIS dealer
Overuse of choke	Inspect, clean and/or replace spark plugs
Clogged fuel filter	Replace the filter
Low battery voltage	Recharge battery with .5 amp charger
Mechanical failure	See your POLARIS dealer

# Troubleshooting

## Engine Doesn't Turn Over

Possible Cause	Solution
Low battery voltage	Recharge battery with .5 amp charger
Loose battery connections	Check all connections and tighten
Loose solenoid connections	Check all connections and tighten

## Engine Pings or Knocks

Possible Cause	Solution
Poor quality or low octane fuel	Replace with recommended fuel
Incorrect ignition timing	See your POLARIS dealer
Incorrect spark plug gap or heat range	Set gap to specs or replace plugs

## Troubleshooting Engine Backfires

<b>Possible Cause</b>	<b>Solution</b>
Weak spark from spark plugs	Inspect, clean and/or replace spark plugs
Incorrect spark plug gap or heat range	Set gap to specs or replace plugs
Old or non-recommended fuel	Replace with new fuel
Incorrectly installed spark plug wires	See your POLARIS dealer
Incorrect ignition timing	See your POLARIS dealer
Mechanical failure	See your POLARIS dealer
Exhaust system leak	See your POLARIS dealer

# Troubleshooting

## Engine Runs Irregularly, Stalls or Misfires

Possible Cause	Solution
Fouled or defective spark plugs	Inspect, clean and/or replace spark plugs
Worn or defective spark plug wires	See your POLARIS dealer
Incorrect spark plug gap or heat range	Set gap to specs or replace plugs
Loose ignition connections	Check all connections and tighten
Water present in fuel	Replace with new fuel
Low battery voltage	Recharge battery with .5 amp charger
Kinked or plugged fuel vent line	Inspect and replace
Incorrect fuel	Replace with recommended fuel
Clogged air filter	Inspect and clean or replace
Electronic throttle control malfunction	See your POLARIS dealer
Other mechanical failure	See your POLARIS dealer

# Troubleshooting

## Engine Runs Irregularly, Stalls or Misfires

<b>Possible Lean Fuel Mixture Cause</b>	<b>Solution</b>
Low or contaminated fuel	Add or change fuel, clean the fuel system
Low octane fuel	Replace with recommended fuel
Clogged fuel filter	Replace filter
<b>Possible Rich Fuel Mixture Cause</b>	<b>Solution</b>
Overuse of choke	Inspect, clean and/or replace spark plugs
Fuel is very high octane	Replace with lower octane fuel

# Troubleshooting

## Engine Stops or Loses Power

Possible Cause	Solution
Out of fuel	Turn the fuel valve to reserve, refuel
Kinked or plugged fuel vent line	Inspect and replace
Water present in fuel	Replace with new fuel
Overuse of choke	Inspect, clean and/or replace spark plugs
Fouled or defective spark plugs	Inspect, clean and/or replace spark plugs
Worn or defective spark plug wires	See your POLARIS dealer
Incorrect spark plug gap or heat range	Set gap to specs or replace plugs
Loose ignition connections	Check all connections and tighten
Low battery voltage	Recharge battery with .5 amp charger
Incorrect fuel	Replace with recommended fuel
Clogged air filter	Inspect and clean or replace
Electronic throttle control malfunction	See your POLARIS dealer
Other mechanical failure	See your POLARIS dealer



## **Warranty**

### **LIMITED WARRANTY**

POLARIS Sales Inc., 2100 Highway 55, Medina, MN 55340, gives a SIX MONTH LIMITED WARRANTY on all components of the POLARIS All Terrain Vehicle (ATV) against defects in material or workmanship.

POLARIS also gives a one year limited warranty on the final drive chain for failure due to defects. This warranty covers the parts and labor charges for repair or replacement of defective parts which are covered by this warranty. This warranty begins on the date of purchase. This warranty is transferable to another consumer during the warranty period through a POLARIS dealer.

### **REGISTRATION**

At the time of sale, the Warranty Registration Form must be completed by your dealer and submitted to POLARIS within ten days. Upon receipt of this registration, POLARIS will record the registration for warranty. No verification of registration will be sent to the purchaser as the copy of the Warranty Registration Form will be the warranty entitlement. If you have not signed the original registration and received the “customer copy”, please contact your dealer immediately. **NO WARRANTY COVERAGE WILL BE ALLOWED UNLESS YOUR ATV IS REGISTERED WITH POLARIS.**

Initial dealer preparation and set-up of your ATV is very important in ensuring trouble-free operation. Purchasing a machine in the crate or without proper dealer set-up will void your warranty coverage.

### **WARRANTY COVERAGE AND EXCLUSIONS: LIMITATIONS OF WARRANTIES AND REMEDIES**

The POLARIS limited warranty excludes any failures that are not caused by a defect in material or workmanship. This warranty does not cover accidental damage, normal wear and tear, abuse or improper handling. This warranty also does not cover any ATV that has been altered structurally, modified, neglected, improperly maintained, used for racing, or used for purposes other than for which it was manufactured, or for any damages which occur during trailer transit or as a result of unauthorized service or the use of unauthorized parts. In addition, this warranty does not cover physical damage to paint or finish, stress cracks, tearing or puncturing of upholstery material, corrosion, or defects in parts, components or the ATV due to fire, explosions or any other cause beyond POLARIS' control.

# Warranty

## WARRANTY COVERAGE AND EXCLUSIONS: LIMITATIONS OF WARRANTIES AND REMEDIES

Warranty does not apply to parts exposed to friction surfaces, stresses, environmental conditions and/or contamination for which they were not designed or not intended, including but not limited to the following items:

- Wheels and tires
- Suspension components
- Brake components
- Seat components
- Clutches and components
- Steering components
- Batteries
- Light bulbs/Sealed beam lamps
- Finished and unfinished surfaces
- Carburetor/Throttle body components
- Engine components
- Drive belts
- Hydraulic components
- Circuit breakers/Fuses
- Electronic components

## **WARRANTY COVERAGE AND EXCLUSIONS: LIMITATIONS OF WARRANTIES AND REMEDIES**

Warranty applies to the product only and does not allow for coverage of personal loss. Some items are considered "consumable," meaning they are considered part of normal maintenance or part of completing an effective repair.

The following items are excluded from warranty coverage in the event of a warranty claim:

- Spark Plugs
- Filters
- Fuel
- Sealants
- Hotel fees
- Towing charges
- Mileage
- Rentals/Loss of product use
- Lubricants such as oil, grease, etc.
- Batteries (unless defective)
- Cosmetic damage/repair
- Coolants
- Meals
- Shipping/ handling fees
- Product pick-up/delivery
- Loss of vacation/personal time

## **Warranty**

### **WARRANTY COVERAGE AND EXCLUSIONS: LIMITATIONS OF WARRANTIES AND REMEDIES**

This warranty also excludes failures resulting from improper lubrication; improper engine timing; improper fuel; surface imperfections caused by external stress, heat, cold or contamination; operator error or abuse; improper component alignment, tension, adjustment or altitude compensation; failure due to snow, water, dirt or other foreign substance ingestion/contamination; improper maintenance; modified components; use of aftermarket components resulting in failure; unauthorized repairs; repairs made after the warranty period expires or by an unauthorized repair center; use of the product in competition or for commercial purposes. Warranty will not apply to any product which has been damaged by abuse, accident, fire or any other casualty not determined a defect of materials or workmanship.

### **WARRANTY COVERAGE AND EXCLUSIONS: LIMITATIONS OF WARRANTIES AND REMEDIES**

This warranty does not cover the use of unauthorized lubricants, chemicals, or fuels that are not compatible with the ATV. The exclusive remedy for breach of this warranty shall be, at POLARIS' exclusive option, repair or replacement of any defective materials, or components or products. THE REMEDIES SET FORTH IN THIS WARRANTY ARE THE ONLY REMEDIES AVAILABLE TO ANY PERSON FOR BREACH OF THIS WARRANTY. POLARIS SHALL HAVE NO LIABILITY TO ANY PERSON FOR INCIDENTAL, CONSEQUENTIAL OR SPECIAL DAMAGES OF ANY DESCRIPTION, WHETHER ARISING OUT OF EXPRESS OR IMPLIED WARRANTY OR ANY OTHER CONTRACT, NEGLIGENCE, OR OTHER TORT OR OTHERWISE. THIS EXCLUSION OF CONSEQUENTIAL, INCIDENTAL, AND SPECIAL DAMAGES IS INDEPENDENT FROM AND SHALL SURVIVE ANY FINDING THAT THE EXCLUSIVE REMEDY FAILED OF ITS ESSENTIAL PURPOSE. Some states do not permit the exclusion or limitation of incidental or consequential damages or implied warranties, so the above limitations or exclusions may not apply to you if inconsistent with controlling state law.

## **Warranty**

### **WARRANTY COVERAGE AND EXCLUSIONS: LIMITATIONS OF WARRANTIES AND REMEDIES**

ALL IMPLIED WARRANTIES (INCLUDING BUT NOT LIMITED TO THE IMPLIED WARRANTIES OF MERCHANTABILITY AND FITNESS FOR A PARTICULAR PURPOSE) ARE LIMITED IN DURATION TO THE ABOVE SIX MONTH WARRANTY PERIOD. POLARIS FURTHER DISCLAIMS ALL EXPRESS WARRANTIES NOT STATED IN THIS WARRANTY. Some states do not allow limitations on how long an implied warranty lasts, so the above limitation may not apply to you if inconsistent with controlling state law.

## HOW TO OBTAIN WARRANTY SERVICE

If your ATV requires warranty service, you must take it to a POLARIS dealer authorized to repair POLARIS ATVs. When requesting warranty service you must present your copy of the Warranty Registration form to the dealer. (THE COST OF TRANSPORTATION TO AND FROM THE DEALER IS YOUR RESPONSIBILITY). POLARIS suggests that you use your original selling dealer; however, you may use any POLARIS Servicing Dealer to perform warranty service.

Please work with your dealer to resolve any warranty issues. Should your dealer require any additional assistance they will contact the appropriate personnel at POLARIS.

This warranty gives you specific legal rights, and you may also have other rights which vary from state to state. If any of the above terms are void because of state or federal law, all other warranty terms will remain in effect.

### Recommended Lubricants

1. Mixing oil brands or using non-recommended oil may cause engine damage. We recommend the use of POLARIS engine oil.
2. Damage resulting from the use of non-recommended lubricants may not be covered by warranty.

### Spark Arrester

POLARIS warrants that the spark arrester in this vehicle will meet the efficiency requirements of USFS standard 5100-1c for at least 1000 hours when subjected to normal use and when maintenance and installation are in accordance with POLARIS recommendations.



## **Warranty**

### **EXPORTED VEHICLES**

EXCEPT WHERE SPECIFICALLY REQUIRED BY LAW, THERE IS NO WARRANTY OR SERVICE BULLETIN COVERAGE ON THIS VEHICLE IF IT IS SOLD OUTSIDE THE COUNTRY OF THE SELLING DEALER'S AUTHORIZED LOCATION.

This policy does not apply to vehicles that have received authorization for export from POLARIS Industries. Dealers may not give authorization for export. You should consult an authorized dealer to determine this vehicle's warranty or service bulletin coverage if you have any questions.

This policy does not apply to vehicles registered to government officials or military personnel on assignment outside the country of the selling dealer's authorized location.

This policy does not apply to Safety Bulletins.

### **How to Get Service**

#### ***In the country where your vehicle was purchased:***

Warranty or Service Bulletin repairs must be done by an authorized POLARIS dealer. If you move or are traveling within the country where your vehicle was purchased, Warranty or Service Bulletin repairs may be requested from any authorized POLARIS dealer who sells the same line as your vehicle.

## EXPORTED VEHICLES

### How to Get Service

#### *Outside the country where your vehicle was purchased:*

If you are traveling temporarily outside the country where your vehicle was purchased, you should take your vehicle to an authorized POLARIS dealer. You must show the dealer photo identification from the country of the selling dealer's authorized location as proof of residence. Upon residence verification, the servicing dealer will be authorized to perform the warranty repair.

#### *If You Move:*

If you move to another country, be sure to contact POLARIS Customer Assistance and the customs department of the destination country before you move. Vehicles importation rules vary considerably from country to country. You may be required to present documentation of your move to POLARIS Industries in order to continue your warranty coverage. You may also be required to obtain documentation from POLARIS Industries in order to register your vehicle in your new country. You should warranty register your vehicle at a local POLARIS dealer in your new country immediately after you move to continue your warranty coverage and to ensure that you receive safety information and notices regarding your vehicle.

# Warranty

## EXPORTED VEHICLES

### How to Get Service

#### *If Purchased From A Private Party:*

If you purchase a POLARIS product from a private citizen outside of the country in which the vehicle was originally purchased, all warranty coverage will be denied. You must nonetheless warranty register your vehicle under your name and address with a local POLARIS dealer in your country to ensure that you receive safety information and notices regarding your vehicle.

#### **Notice**

If your vehicle is registered outside of the country where it was purchased, and you have not followed the procedure set out above, your vehicle will no longer be eligible for warranty or service bulletin coverage of any kind, other than *safety* bulletins. (Vehicles registered to Government officials or military personnel on assignment outside of the country where the vehicle was purchased will continue to be covered by the basic warranty.)

#### *For questions call POLARIS Customer Assistance:*

United States: 1-888-704-5290

Canada: 1-204-925-7100

## **U.S.A. EPA Emissions Limited Warranty**

This emissions limited warranty is in addition to the POLARIS standard limited warranty for your vehicle. POLARIS Industries Inc. warrants that at the time it is first purchased, this emissions-certified vehicle is designed, built and equipped so it conforms with applicable U.S. Environmental Protection Agency emission regulations. POLARIS warrants that the vehicle is free from defects in materials and workmanship that would cause it to fail to meet these regulations.

The warranty period for this emissions-certified vehicle starts on the date the vehicle is first purchased and continues for a period of 250 hours of engine operation, 2500 kilometers (1550 miles) of vehicle travel, or 30 calendar months from the date of purchase, whichever comes first.

This emissions limited warranty covers components whose failure increases the vehicle's regulated emissions, and it covers components of systems whose only purpose is to control emissions. Repairing or replacing other components not covered by this warranty is the responsibility of the vehicle owner. This emissions limited warranty does not cover components whose failure does not increase the vehicle's regulated emissions.

# Warranty

## U.S.A. EPA Emissions Limited Warranty

For exhaust emissions, emission-related components include any engine parts related to the following systems:

- Air-induction system
- Fuel system
- Ignition system
- Exhaust gas recirculation systems

The following parts are also considered emission-related components for exhaust emissions:

- Aftertreatment devices
- Crankcase ventilation valves
- Sensors
- Electronic control units

The following parts are considered emission-related components for evaporative emissions:

- Fuel Tank
- Fuel Cap
- Fuel Line
- Fuel Line Fittings
- Clamps\*
- Pressure Relief Valves\*
- Control Valves\*
- Control Solenoids\*
- Electronic Controls\*
- Vacuum Control Diaphragms\*
- Control Cables\*
- Control Linkages\*
- Purge Valves
- Vapor Hoses
- Liquid/Vapor Separator
- Carbon Canister
- Canister Mounting Brackets
- Carburetor Purge Port Connector

\*As related to the evaporative emission control system.

## U.S.A. EPA Emissions Limited Warranty

The exclusive remedy for breach of this limited warranty shall be, at the exclusive option of POLARIS, repair or replacement of any defective materials, components or products. THE REMEDIES SET FORTH IN THIS LIMITED WARRANTY ARE THE ONLY REMEDIES AVAILABLE TO ANY PERSON FOR BREACH OF THIS WARRANTY. POLARIS SHALL HAVE NO LIABILITY TO ANY PERSON FOR INCIDENTAL, CONSEQUENTIAL OR SPECIAL DAMAGES OF ANY DESCRIPTION, WHETHER ARISING OUT OF EXPRESS OR IMPLIED WARRANTY OR ANY OTHER CONTRACT, NEGLIGENCE OR OTHER TORT OR OTHERWISE. THIS EXCLUSION OF CONSEQUENTIAL, INCIDENTAL, AND SPECIAL DAMAGES IS INDEPENDENT FROM AND SHALL SURVIVE ANY FINDING THAT THE EXCLUSIVE REMEDY FAILED OF ITS ESSENTIAL PURPOSE.

ALL IMPLIED WARRANTIES (INCLUDING BUT NOT LIMITED TO ANY IMPLIED WARRANTIES OF MERCHANTABILITY AND FITNESS FOR A PARTICULAR PURPOSE) ARE LIMITED IN DURATION TO THE WARRANTY PERIOD DESCRIBED HEREIN. POLARIS DISCLAIMS ALL EXPRESS WARRANTIES NOT STATED IN THIS WARRANTY. Some states do not allow limitations on how long an implied warranty lasts, so the above limitation may not apply if it is inconsistent with the controlling state law.

## **Warranty**

### **U.S.A. EPA Emissions Limited Warranty**

This limited warranty excludes failures not caused by a defect in material or workmanship. This limited warranty does not cover damage due to accidents, abuse or improper handling, maintenance or use. This limited warranty also does not cover any engine that has been structurally altered, or when the vehicle has been used in racing competition. This limited warranty also does not cover physical damage, corrosion or defects caused by fire, explosions or other similar causes beyond the control of POLARIS.

Owners are responsible for performing the scheduled maintenance identified in the owner's manual. POLARIS may deny warranty claims for failures that have been caused by the owner's or operator's improper maintenance or use, by accidents for which POLARIS has no responsibility, or by acts of God.

Any qualified repair shop or person may maintain, replace, or repair the emission control devices or systems on your vehicle. POLARIS recommends that you contact an authorized POLARIS dealer to perform any service that may be necessary for your vehicle. POLARIS also recommends that you use only Pure POLARIS parts. It is a potential violation of the Clean Air Act if a part supplied by an aftermarket parts manufacturer reduces the effectiveness of the vehicle's emission controls. Tampering with emission controls is prohibited by federal law.

If you have any questions regarding your warranty rights and responsibilities, please contact the POLARIS Warranty Department at 1-888-704-5290.

# Maintenance Log

Present this section of your manual to your dealer each time your vehicle is serviced. This will provide you and future owners with an accurate log of maintenance and services performed.

DATE	SERVICE INTERVAL	TECHNICIAN	SERVICE PERFORMED / COMMENTS
	10 Hours (Break-in)		
	40 Hours		
	50 Hours		
	80 Hours		



# Maintenance Log

DATE	SERVICE INTERVAL	TECHNICIAN	SERVICE PERFORMED / COMMENTS
	100 Hours		
	120 Hours		
	150 Hours		

# Maintenance Log

DATE	SERVICE INTERVAL	TECHNICIAN	SERVICE PERFORMED / COMMENTS

# Maintenance Log

DATE	SERVICE INTERVAL	TECHNICIAN	SERVICE PERFORMED / COMMENTS

# Index

## A

Accessories .....	154
Age Restrictions .....	13
Air Filter .....	136-137
Axle and Wheel Nuts .....	141

## B

### Battery

Installation and Connections	146
Removal .....	145
Storage .....	147, 151
Boots .....	11
Brake Adjustment, Front. . . . .	126-127
Brake Adjustment, Rear . . . . .	128
Brake Freeplay .....	125-128
Brake Freeplay Specifications . . .	125
Brake Lever Travel .....	129
Brake Levers .....	44
Brake, Parking .....	63-64
Brakes .....	62-64
Break-in Period .....	70-71

## C

Camber and Caster .....	132
Carburetor .....	120-121
Choke Lever .....	58
Cleaning .....	147
Clothing .....	11
Consumer Product Safety .....	9
CVT Drying .....	117
CVT System .....	116-117
Cylinder Head Torque .....	114

## D

Daytime Running Lights .....	143
Drive Chain .....	133
Drive Chain Slack .....	134
Drive Chain Slack Adjustment . . .	135
Driving Downhill .....	85
Driving on a Sidehill .....	84
Driving on Slippery Surfaces .....	89
Driving Over Obstacles .....	81
Driving Procedure .....	79
Driving Through Water .....	90-91
Driving Uphill .....	82-83

## E

Electronic Throttle Control .....	61
Emission Control Systems .....	93
Engine Start Button .....	59
Engine Stop Switch .....	58
Equipment Modifications .....	12
Exhaust, Exposure to .....	15
Eye Protection .....	11

## F

Fuel Filter .....	109
Fuel Safety .....	15
Fuel Stabilizer .....	152
Fuel System .....	65
Fuel Valve .....	66

## G

Gas Cap .....	43, 65
Gasoline Handling .....	15
Gearcase Capacity .....	111
Gloves .....	11

# Index

## H

Handlebar Adjustment . . . . .	138
Helmet . . . . .	10
Horn . . . . .	59
Horn Button . . . . .	41

## I

Instruction, Operating. . . . .	14
---------------------------------	----

## K

Key Switch . . . . .	57
Kick-Start Lever . . . . .	42, 68-69
K-Turn . . . . .	86

## L

<b>Lamp Replacement</b>	
Daytime Running Lights . . . . .	143
Tail Light . . . . .	142
Lights . . . . .	64
Lights, Daytime Running . . . . .	143
Lubrication Guide . . . . .	102-103

## M

Main Key Switch . . . . .	57
Maintenance Chart . . . . .	94-101
Making Turns . . . . .	80
Modifications. . . . .	12

## O

Oil . . . . .	104
Oil Change, Engine . . . . .	106-108
Oil Change, Transmission . . . . .	111
Oil Check, Engine . . . . .	105
Oil Check, Transmission . . . . .	110
Oil, Engine. . . . .	104
Operator Restrictions. . . . .	13

## P

Parking on a Hill or Incline . . . . .	88
Periodic Maintenance Chart . . . . .	94-101
Polaris Products . . . . .	158
Polishing . . . . .	150
Pre-Ride Inspection . . . . .	72-73

## R

Restrictions, Age . . . . .	13
Riding Gear. . . . .	10-11

## S

Safe Operation Practices. . . . .	74-75
<b>Safety Labels and Locations . . . . .</b>	<b>32-37</b>
Age Warning . . . . .	34
Clutch Cover Warning. . . . .	37
Discretionary Warning . . . . .	32
No Passenger Warning . . . . .	36
Operation Warning . . . . .	33
Tire Pressure Warning. . . . .	35
Safety Training . . . . .	8-9
<b>Safety Warnings . . . . .</b>	<b>13-31</b>
Age Restrictions . . . . .	13
Carrying a Passenger. . . . .	17
Crossing Hillsides . . . . .	23
Descending Hills Improperly . . . . .	22
Exposure to Exhaust . . . . .	15
Failure to Inspect. . . . .	16

# Index

## S

<b>Safety Warnings</b> . . . . .	<b>13-31</b>
Frozen Bodies of Water . . . . .	30
Handling Gasoline . . . . .	15
Hot Exhaust Systems . . . . .	31
Improper Cargo Loading . . . . .	29
Improper Hill Climbing . . . . .	21
Improper Tire Maintenance . . . . .	26
Improper Modifications . . . . .	27
Jumps and Stunts . . . . .	20
Operating a Damaged ATV . . . . .	30
Operating at Excessive Speeds . . . . .	19
Operating on Pavement . . . . .	18
Operating on Public Roads . . . . .	18
Operating on Slippery Terrain . . . . .	25
Operating on Steep Hills . . . . .	21
Operating Over Obstacles . . . . .	27
Operating Through Water . . . . .	28
Operating Without Instruction . . . . .	14
Physical Control of the ATV . . . . .	19
Physical Skills . . . . .	30
Protective Apparel . . . . .	16

## S

<b>Safety Warnings</b> . . . . .	<b>13-31</b>
Skidding or Sliding . . . . .	27
Stalling While Climbing a Hill . . . . .	24
Turning Improperly . . . . .	20
Unauthorized Use of the ATV . . . . .	31
Unfamiliar Terrain . . . . .	26
Using Alcohol or Drugs . . . . .	17
Safety Words and Symbols . . . . .	6
Seat Latch . . . . .	43
Severe Use . . . . .	95
Shock Spring Adjustment . . . . .	132
Sidehilling . . . . .	84
Signal words . . . . .	6
Spark Arrester . . . . .	118-119
Spark Plug Change . . . . .	113
Spark Plugs . . . . .	112-113
Specifications . . . . .	156-157
Speed Control System . . . . .	122-123
Start Button . . . . .	59
Starting the Engine . . . . .	76-77
Steering Inspection . . . . .	132

## S

Stop Switch . . . . .	58
Stopping the ATV . . . . .	46
Stopping the Engine . . . . .	78
Storage . . . . .	151-154
<b>Switches</b>	
Engine Start Button . . . . .	59
Engine Stop Switch . . . . .	41, 58
Horn Button . . . . .	41
Ignition Switch . . . . .	45
Main Key Switch . . . . .	57
Tether Switch . . . . .	45

## T

Tail Light . . . . .	142
Tether Strap . . . . .	45
Throttle . . . . .	60
Throttle Cable Adjustment . . . . .	124
Throttle Control . . . . .	41
Throttle Lever . . . . .	61
Throttle Stop Speed Control . . . . .	123

# Index

## T

Tire Tread Depth .....	140
Tires .....	139
Toe Alignment .....	130-131
Transmission .....	116-117
Transmission Oil .....	110-111
Transporting the ATV .....	155
Turning Around on a Hill.....	86-87

## V

Vehicle Identification Numbers ..	56
Vehicle Immersion .....	114-115

## W

Warranty .....	166-176
Warranty, Emissions .....	177-180
Washing the ATV .....	148
Wheel Hub Tightening .....	141
Wheel Installation .....	141
Wheel Nuts .....	141
Wheel Removal .....	140