

IMPORTANT NOTICE TO OWNER

*Modifications to this snowmobile are not recommended
and may result in voided warranty coverage.
Please read the warranty section of this manual carefully.*

2014

 **POLARIS®**

600 Switchback®
600 Switchback® Pro-R
600 Switchback Adventure™

800 Switchback®
800 Switchback® Pro-R
800 Switchback® Pro-R Adventure

Snowmobile Owner's Manual
for Maintenance and Safety

 WARNING

Read, understand, and follow all of the instructions and safety precautions in this manual and on all product labels.

Failure to follow the safety precautions could result in serious injury or death.

 WARNING

The engine exhaust from this product contains chemicals known to the State of California to cause cancer, birth defects or other reproductive harm.

WELCOME

Thank you for purchasing a POLARIS vehicle, and welcome to our world-wide family of POLARIS enthusiasts. Be sure to visit us online at www.polaris.com for the latest news, new product introductions, upcoming events, career opportunities and more.

Here at POLARIS we proudly produce an exciting line of utility and recreational products.

- Snowmobiles
- All-terrain vehicles (ATVs)
- Low emission vehicles (LEVs)
- *RANGER*® utility vehicles
- *VICTORY*® motorcycles
- *GEM*® vehicles

We believe POLARIS sets a standard of excellence for all utility and recreational vehicles manufactured in the world today. Many years of experience have gone into the engineering, design, and development of your POLARIS vehicle, making it the finest machine we've ever produced.

For safe and enjoyable operation of your vehicle, be sure to follow the instructions and recommendations in this owner's manual. Your manual contains instructions for minor maintenance, but information about major repairs is outlined in the POLARIS Service Manual and should be performed only by a factory certified Master Service Dealer® (MSD) technician.

Your POLARIS dealer knows your vehicle best and is interested in your total satisfaction. Be sure to return to your dealership for all of your service needs during, and after, the warranty period.



POLARIS®

POLARIS, PERC, PRO-RIDE and SWITCHBACK are registered trademarks of POLARIS Industries Inc.

SWITCHBACK ADVENTURE is a trademark of POLARIS Industries Inc.

Copyright 2013 POLARIS Sales Inc. All information contained within this publication is based on the latest product information at the time of publication. Due to constant improvements in the design and quality of production components, some minor discrepancies could result between the actual vehicle and the information presented in this publication. Depictions and/or procedures in this publication are intended for reference use only. No liability can be accepted for omissions or inaccuracies. Any reprinting or reuse of the depictions and/or procedures contained within, whether whole or in part, is expressly prohibited.

The original instructions for this vehicle are in English. Other languages are provided as translations of the original instructions.

Printed in U.S.A.

2014 600 SWITCHBACK/800 SWITCHBACK Owner's Manual

P/N 9924269

TABLE OF CONTENTS

Introduction	5
This section contains helpful information for owners and drivers and illustrates the location of important identification numbers that should be recorded in the owner's manual.	
Safety	8
This section describes safe vehicle operation and identifies warning labels and their locations.	
Features	24
This section identifies the locations of your snowmobile's controls and features.	
The Perfect Fit	46
This section includes a Suspension Quick Set-Up Guide and explains how to make additional suspension adjustments for the perfect riding experience.	
Pre-Ride Inspections	60
This section explains procedures that must be performed before riding.	
Operation	67
This section explains proper engine break-in, operation of features and general operating procedures.	
Maintenance	80
This section defines your role, and your dealer's role, in your snowmobile's regular maintenance.	
POLARIS Products	116
Troubleshooting	117
Specifications	122
Warranty	126
Maintenance Log	134
Index	137

INTRODUCTION

Important Notes for Owners and Drivers

After reading this manual, store it in the snowmobile for convenient reference. It should remain with the snowmobile when the snowmobile is sold.

Some of the illustrations and photos used in this manual are general representations. Your model may differ.

Follow the maintenance program outlined in this manual. Preventive maintenance ensures that critical components of the snowmobile are inspected by your dealer at specific mileage intervals.

You and your dealer must complete the registration form included with your snowmobile and forward it to us. This completed form is necessary to ensure warranty coverage.

Protect and preserve your right to ride by joining your local trail riding clubs.

When teaching inexperienced operators to ride, set up a predetermined course for practice. Make sure they know how to drive and control the snowmobile before allowing them to make longer trips. Teach them proper snowmobile courtesy, and enroll them in driver's training and safety courses sponsored by local or state organizations.

INTRODUCTION

Preservation of the Environment

POLARIS is committed to supporting an environmental education campaign. We encourage state and provincial governments across the snowbelt to adopt rigorous safety training programs that encourage protection of our environment, including wildlife and vegetation.

Snowmobile clubs and other organizations are working together to protect our environment. Please support their efforts and operate your snowmobile with consideration for the protection and preservation of our environment.

Noise Level

One of the most publicized issues about snowmobiles is noise. The Society of Automotive Engineers (SAE), the standard-setting body for snowmobile development, recommends that snowmobiles conform to prescribed sound levels.

POLARIS snowmobiles are engineered to conform to these SAE standards. Our muffler systems are designed to reduce noise levels and must not be altered or removed. The sound of your snowmobile may not be welcome to non-snowmobilers, so you have a responsibility to operate your snowmobile with concern for others. We do our part by manufacturing quieter machines; we ask your help to further reduce the impact of noise by operating your snowmobile safely and responsibly.

Air Pollution

POLARIS engineers continuously investigate ways to reduce emission levels of two-stroke engines. We expect our efforts to lead to the reduction of potential air pollution.

In addition to our technological research, we encourage government agencies, manufacturers, distributors, dealers, ecologists, and other interested parties to work together to develop data on environmental topics.

INTRODUCTION

Vehicle Identification Numbers

Record your snowmobile's identification numbers and key number in the spaces provided. Remove the spare key and store it in a safe place. Your key can be duplicated only by mating a POLARIS key blank with one of your existing keys, so if both keys are lost, the ignition switch must be replaced.



Tunnel VIN

Vehicle Model Number: _____

Tunnel VIN (right side of tunnel): _____

Engine Serial Number (on recoil housing): _____

Key Number: _____

SAFETY

Operator Safety

The following signal words and symbols appear throughout this manual and on your vehicle. Your safety is involved when these words and symbols are used. Become familiar with their meanings before reading the manual.



The safety alert symbol indicates a potential personal injury hazard.

DANGER

A DANGER indicates a hazardous situation that, if not avoided, will result in death or serious injury.

WARNING

A WARNING indicates a hazardous situation that, if not avoided, could result in death or serious injury.

CAUTION

A CAUTION indicates a hazardous situation that, if not avoided, could result in minor or moderate injury.

NOTICE

A NOTICE indicates a situation that could result in property damage.



The Prohibition Safety Sign indicates an action NOT to take in order to avoid a hazard.



The Mandatory Action Sign indicates an action that NEEDS to be taken to avoid a hazard.

Operator Safety

Follow the recommended maintenance program beginning on page 81 of this manual to ensure that all critical components on the snowmobile are thoroughly inspected by your dealer at specific mileage intervals.

WARNING

Driving a snowmobile requires your full attention. **DO NOT** drink alcohol or use drugs or medications before or while driving or riding as a passenger. They will reduce your alertness and slow your reaction time.

Snowmobiles are capable of traveling at high speeds. Use extra caution to ensure operator safety. Make sure your snowmobile is in excellent operating condition at all times. Always check major and vital safety components before every ride.

All POLARIS snowmobiles are designed and tested to provide safe operation when used as directed. Failure of critical machine components may result from operation with any modifications, especially those that increase speed or power. **DO NOT MODIFY YOUR MACHINE.** The snowmobile may become aerodynamically unstable at speeds higher than those for which it is designed. Loss of control may occur at higher speeds. Modifications may also create a safety hazard and lead to bodily injury.

The warranty on your entire machine is terminated if any equipment has been added, or any modifications have been made, to increase the speed or power of the snowmobile.

SAFETY

Operator Safety

Stay Clear of Track

Your snowmobile is propelled by a revolving track that must be partially exposed for proper operation. Do not stand on the plastic flap.

WARNING! Serious injuries may result if hands, feet, or clothing become entangled in the track. Be alert when riding, and remain properly seated to stay clear of the track. Never hold the snowmobile up or stand behind it while warming up the track. A loose track or flying debris could cause serious injury or death. We recommend having your dealer perform all track service and alignment procedures.

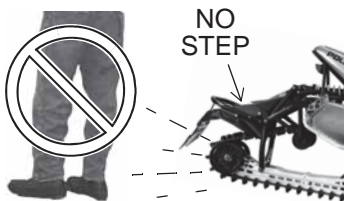

Stay Clear of Engine

Never attempt adjustments with the engine running. Turn off the ignition, open the side panels or hood, make the adjustment, secure shields and guards, secure the side panels and hood, and then restart the engine to check its operation.

WARNING! Serious injury can occur if fingers or clothing contact the moving parts of an engine. Always stop the engine before attempting adjustments.

Riding Position

Operating a snowmobile requires skill and balance for proper control. Rider positions may vary with experience and the features available on some snowmobiles, but under many conditions, the proper position is to be seated with both feet on the running boards and both hands on the handlebar grips for proper throttle, brake and steering control.

WARNING! Improper riding position may reduce control and could result in serious injury or death. Always ride in a position that allows for control of your vehicle.

Operator Safety Riding Apparel

Helmet

Wearing a helmet can prevent a severe head injury. Whenever riding a POLARIS vehicle, always wear a helmet that meets or exceeds established safety standards.

Approved helmets in the USA and Canada bear a U.S. Department of Transportation (DOT) label.

Approved helmets in Europe, Asia and Oceania bear the ECE 22.05 label. The ECE mark consists of a circle surrounding the letter E, followed by the distinguishing number of the country which has granted approval. The approval number and serial number will also be displayed on the label.

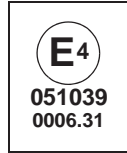

Eye Protection

Do not depend on eyeglasses or sunglasses for eye protection. Whenever riding a POLARIS vehicle, always wear shatterproof goggles or use a shatterproof helmet face shield. POLARIS recommends wearing approved Personal Protective Equipment (PPE) bearing markings such as VESC 8, V-8, Z87.1, or CE. Make sure protective eye wear is kept clean.

Clothing

Be prepared, be warm and be comfortable when riding. Be aware of the weather forecast, especially the windchill, and dress accordingly. See the chart on page 20.

WARNING! Avoid wearing loose clothing or long scarves, which can become entangled in moving parts and cause serious injury. Always wear an approved helmet and eye protection.



SAFETY

Operator Safety

Disabled Operators

Safe operation of this rider-active vehicle requires good judgement and physical skills. Operators with cognitive or physical disabilities have an increased risk of loss of control, which could result in serious injury or death.

Survival Preparation

For your safety, always ride in a group of other snowmobilers. Always tell someone where you're going and how long you expect to be gone. If it isn't possible to ride with others, and you must travel into remote areas, always carry survival equipment that's appropriate to the conditions you may encounter. Such equipment may include, but is not limited to: extra clothing, a sleeping bag, a flashlight, food and water, a signaling mirror, a means of building a fire, and a two-way radio or cellular telephone.

Always carry the owner's manual on your snowmobile. For added protection, purchase and carry the following items on your snowmobile as well:

- Spare Drive Belt
- Extra Set of Spark Plugs
- Tow Rope
- Extra Oil
- Fuel Deicer
- Winter Survival Kit
- Trail Map
- First Aid Kit
- Tool Kit

Operator Safety

Rider Capacity

This snowmobile is designed for a single rider only. Never carry a passenger on this snowmobile.

Excessive Speed

WARNING! High speed driving, especially at night, could result in serious injury or death. Always reduce speed when driving at night or in inclement weather.

Always observe all state and local laws governing snowmobile operation and speed limits. Always be alert and pay attention to the trail ahead. If your speed is 40 MPH (64 km/h), your snowmobile is traveling about 60 feet (18 m) per second. If you look back for only two seconds, your snowmobile will travel about 120 feet (36 m). If your speed is 60 MPH (96 km/h), your snowmobile will travel about 180 feet (55 m) in two seconds.

Traveling at night requires extra caution. Check headlight and taillight to ensure proper operation, and don't over-drive your headlight beam. Always be able to bring your snowmobile to a stop in the distance illuminated by the headlight.

SAFETY

Operator Safety

Driver Awareness

Slow down when traveling near poles, posts, or other obstacles. Be especially alert if you're snowmobiling after dark. Always be on the alert for wire fences. Single strands are especially dangerous, since there may be a great distance between posts. Guy wires on utility poles are also difficult to distinguish.

Make sure the way is clear before crossing railroads and other roads and highways. The noise of your snowmobile will drown out the sound of approaching vehicles. Look ahead, behind, and to both sides before turning or crossing railroad tracks or highways. Steep embankments may also hide your view. Always leave yourself a way out.

Variances in snow depth and/or water currents may result in uneven ice thickness. You may drown if you break through the ice. Never travel on frozen bodies of water unless you have first verified that the ice is sufficiently thick to support the weight and moving force of the snowmobile, you and your cargo, together with any other vehicles in your party. Always check with local authorities and residents to confirm ice conditions and thickness over your entire route. Snowmobile operators assume all risk associated with ice conditions on frozen bodies of water.

When teaching inexperienced operators to ride, set up a predetermined course for practice. Make sure they know how to drive and control the snowmobile before allowing them to make longer trips. Teach them proper snowmobile courtesy, and enroll them in driver's training and safety courses.

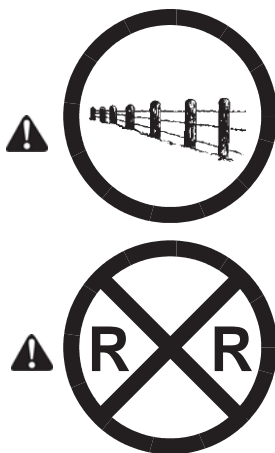

Operator Safety Avalanches

Snowmobilers should always be properly trained and equipped before traveling in mountainous terrain:

- Take an avalanche class
- Travel with experienced people
- Travel on designated trails
- Make sure each person is equipped with a shovel, probe and avalanche beacon.



You don't have to be snowmobiling on a slope for an avalanche to occur. Be aware that all of the snow is connected. You may be riding on a flat slope or snow covered road, but if the snowpack above is unstable enough you can trigger an avalanche on a steeper slope above you. Always be aware of snow conditions above you as you travel in mountainous terrain.

Before riding in mountainous terrain, call or log on to your local avalanche advisory to get current weather and snow stability information.

For more information about avalanche training and avalanche conditions, contact local law enforcement in your area, or visit the American and Canadian online avalanche centers at www.avalanche.org.

SAFETY

Operator Safety

Ice and Snow Build-up

WARNING! Ice and snow build-up may interfere with the steering of your snowmobile, resulting in serious injury or death. Keep the underhood area free of snow and ice.

Before driving, manually turn the skis to the left and right to be sure ice and snow are not interfering with full left and right steering. If difficulty is encountered, remove ice and snow build-up that may be obstructing the steering linkage.

Driving on Slippery Surfaces

WARNING! Never attempt an abrupt change of direction when operating on slippery surfaces. Proceed slowly and use extra caution. Driving on ice or hard-packed snow reduces steering and braking control, which may result in loss of control and serious injury or death. Slow down and use extra caution when operating on slippery surfaces.

Inadequate Snow Conditions

Since snow provides the only lubrication for the power slide suspension and, on liquid cooled models, cooling for the engine, adequate snow cover is a requirement for operation of your snowmobile.

NOTICE: Driving in too little snow will result in excessive wear and damage to the slide rail, track and/or engine.

WARNING! Inadequate cooling and lubrication will lead to overheating of the slide rail and track, causing premature wear, damage and failure, which can result in serious injury. Reduce speeds and frequently drive into fresh snow to allow adequate cooling and polishing of the slide rail and track surfaces. Avoid operating for prolonged periods on ice, hard-packed surfaces or roads.

Operating in Deep Snow

If the snowmobile becomes stuck in snow, clear the running board area of snow, then step down the snow in front of the snowmobile so that when the throttle is opened, the snowmobile will be able to climb up and over the snow.

Operator Safety

Driving Downhill

When riding downhill, shift your weight to the rear of the snowmobile and reduce your speed to a minimum. Apply just enough throttle to keep the clutch engaged, allowing the engine's compression to help slow the snowmobile and keep it from rolling freely downhill.

WARNING! When driving on long downhill stretches, pump the brakes. Riding the brakes may cause the brake system to overheat, which may result in brake failure. Excessive or repetitive use of the brakes for high speed stops will also cause an overheated brake system. This condition may lead to a sudden loss of brakes and/or fire and may result in serious injury or death.

Driving in Hilly Terrain

WARNING! Climbing a hill or crossing the face of a slope may result in loss of balance and snowmobile rollover, causing serious injury or death. Use caution and good judgement when driving in hilly terrain.

Use extra caution when operating in hilly terrain. If climbing a hill is unavoidable, keep your weight low and forward. If you must cross the face of a slope, keep your weight on the uphill side of the snowmobile to maintain proper balance and avoid possible roll-over.

Slow down when reaching the crest of a hill. Be prepared to react to obstacles, sharp drops or other people or vehicles that may be on the other side of the hill.

If you're unable to continue up a hill, turn the snowmobile downhill before it loses momentum. If this isn't possible, spin the track just enough to dig in to prevent it from rolling back down the hill. Stop the engine and set the parking brake (if equipped). Keeping away from the downhill side of the snowmobile, pull the rear of the snowmobile around and point the front end and skis downhill. Remount the snowmobile, restart the engine, release the parking brake, and descend the hill carefully.

SAFETY

Operator Safety

Drive Belt

Do not operate the engine with the drive belt removed.

Any servicing that requires operation without a belt must be performed by your dealer.

NOTICE: Operation of the engine with the belt removed may result in injury or damage to the engine.

Intake Silencer

Do not operate the engine with the intake silencer or filter removed.

NOTICE: Damage to the engine may occur if the intake silencer or filter are removed.

Clutches

Do not attempt to service the clutches.

All clutch service must be performed by your dealer. The clutch is a complex mechanism that rotates at high speeds. Each clutch is dynamically balanced before installation. Any tampering may disrupt this precision balancing and create an unstable condition.

Cold Weather Drive-Away

Whenever your snowmobile has been parked for a length of time, especially overnight, always make sure the skis and track are loosened from ice and snow before attempting to drive. Apply the throttle with enough authority to put the snowmobile into motion, but always operate within safety limits.

Maneuverability

While much control and maneuverability is achieved through the steering system and skis, maximum control is achieved by the shifting of your body weight. Maneuverability will change for lighter operators or snowmobiles designed to carry a load.

Operator Safety Driving Responsibly

Every snowmobile handles differently, and even the most docile conditions may become dangerous if operators drive improperly. If you're new to snowmobiling, acquaint yourself with the snowmobile and with what it will and won't do under various conditions. Even seasoned drivers should spend some time getting the feel for a snowmobile before attempting ambitious maneuvers.

- A snowmobile depends on the rider's body position for proper balance in executing turns, traversing hills, etc. Always start on a smooth, level area to begin building your operating experience.
- Before allowing someone else to use your snowmobile, know the extent of their operating skills. Check to see if they've taken a snowmobile safety course and have an operator's certificate. For their protection, as well as yours, make sure they take a snowmobile safety course. Everyone can benefit from the course.
- Don't “jump” your snowmobile over large drifts or similar terrain. Jumping may injure your back because of spinal compression that could occur when the snowmobile impacts the ground. The seat and suspension of your snowmobile have been designed to provide protection under normal riding conditions. Your snowmobile is not intended for this kind of use.
- Be courteous to oncoming traffic by dimming your headlights and reducing your speed.
- When traveling in a group of snowmobiles, don't tailgate (follow too closely). Leave enough distance between snowmobiles to provide ample stopping room and to provide protection from flying snow and debris. Allow even more distance when driving on slippery surfaces or when driving in darkness or other low visibility conditions. Be aware of any snowmobile traffic around your vehicle. Drive defensively to avoid accidents.
- Remove the key from the ignition when you leave the snowmobile unattended.

SAFETY

Operator Safety

Windchill/Temperature Charts

The following information is provided to help you determine when temperatures become dangerous for riding.

WINDCHILL CHART (°F)

Wind Speed in MPH	Actual Thermometer Reading (°F)																	
	40	35	30	25	20	15	10	5	0	-5	-10	-15	-20	-25	-30	-35	-40	-45
	Equivalent Temperature (°F)																	
Calm	40	35	30	25	20	15	10	5	0	-5	-10	-15	-20	-25	-30	-35	-40	-45
5	36	31	25	19	13	7	1	-5	-11	-16	-22	-28	-34	-40	-46	-52	-57	-63
10	34	27	21	15	9	3	-4	-10	-16	-22	-28	-35	-41	-47	-53	-59	-66	-72
15	32	25	19	13	6	0	-7	-13	-19	-26	-32	-39	-45	-51	-58	-64	-71	-77
20	30	24	17	11	4	-2	-9	-15	-22	-29	-35	-42	-48	-55	-61	-68	-74	-81
25	29	23	16	9	3	-4	-11	-17	-24	-31	-37	-44	-51	-58	-64	-71	-78	-84
30	28	22	15	8	1	-5	-12	-19	-26	-33	-39	-46	-53	-60	-67	-73	-80	-87
35	28	21	14	7	0	-7	-14	-21	-27	-34	-41	-48	-55	-62	-69	-76	-82	-89
40	27	20	13	6	-1	-8	-15	-22	-29	-36	-43	-50	-57	-64	-71	-78	-84	-91
45	26	19	12	5	-2	-9	-16	-23	-30	-37	-44	-51	-58	-65	-72	-79	-86	-93
50	26	19	12	4	-3	-10	-17	-24	-31	-38	-45	-52	-60	-67	-74	-81	-88	-95
55	25	18	11	4	-3	-11	-18	-25	-32	-39	-46	-54	-61	-68	-75	-82	-89	-97
60	25	17	10	3	-4	-11	-19	-26	-33	-40	-48	-55	-62	-69	-76	-84	-91	-98
Frostbite in >>							30 min.	10 min.	5 min.									

WINDCHILL CHART (°C)

Wind Speed in Km/h	Actual Thermometer Reading (°C)																	
	5	2	-1	-4	-7	-10	-13	-16	-19	-22	-25	-28	-31	-34	-37	-40	-43	-46
	Equivalent Temperature (°C)																	
Calm	5	2	-1	-4	-7	-10	-13	-16	-19	-22	-25	-28	-31	-34	-37	-40	-43	-46
8	3	0	-4	-7	-11	-14	-18	-22	-25	-29	-32	-36	-39	-43	-46	-50	-53	-57
16	2	-2	-6	-10	-13	-17	-21	-24	-28	-32	-36	-39	-43	-47	-50	-54	-58	-62
24	1	-3	-7	-11	-15	-19	-22	-26	-30	-34	-38	-42	-45	-49	-53	-57	-61	-65
32	0	-4	-8	-12	-16	-20	-24	-28	-32	-36	-39	-43	-47	-51	-55	-59	-63	-67
40	-1	-5	-9	-13	-17	-21	-25	-29	-33	-37	-41	-45	-49	-53	-57	-61	-65	-69
48	-1	-5	-9	-13	-18	-22	-26	-30	-34	-38	-42	-46	-50	-54	-58	-62	-66	-70
56	-2	-6	-10	-14	-18	-22	-26	-31	-35	-39	-43	-47	-51	-55	-59	-64	-68	-72
64	-2	-6	-10	-15	-19	-23	-27	-31	-35	-40	-44	-48	-52	-56	-61	-65	-69	-73
72	-2	-7	-11	-15	-19	-23	-28	-32	-36	-40	-45	-49	-53	-57	-61	-66	-70	-74
80	-3	-7	-11	-15	-20	-24	-28	-33	-37	-41	-45	-50	-54	-58	-62	-67	-71	-75
88	-3	-7	-12	-16	-20	-24	-29	-33	-37	-42	-46	-50	-55	-59	-63	-67	-72	-76
96	-3	-8	-12	-16	-21	-25	-29	-34	-38	-42	-47	-51	-55	-60	-64	-68	-73	-77
Frostbite in >>							30 min.	10 min.	5 min.									

Safety Labels and Locations

Warning labels have been placed on the snowmobile for your protection. Read and follow the instructions of the labels and other warnings on the snowmobile carefully. If any of the labels depicted in this manual differ from the labels on your snowmobile, always read and follow the instructions of the labels on the snowmobile.

If any label becomes illegible or comes off, contact your POLARIS dealer to purchase a replacement. Replacement safety labels are provided by POLARIS at no charge. The part number is printed on the label.

Clutch Warning

This warning label is found on the oil bottle:

WARNING

Do not operate engine with hood or side panels open.

Do not attempt adjustment with engine running.

Do not operate engine with the clutch guard removed.

Never run engine with drive belt removed.

Never service clutches yourself. See your dealer.

Pressure Cap Warning

This warning label is found on the pressure cap of applicable liquid cooled models:

WARNING

Do not open hot. Test or replace when changing coolant. Press down and turn to release cap. 13 PSI

SAFETY

Safety Labels and Locations

Track Warning

WARNING

Stay clear of track. Do not sit on seat back. Entanglement with the track or a fall from seat back may result in severe injury or death.

Track
Warning

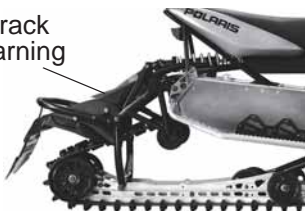

No Passenger Warning/Fuel Recommendation Label

WARNING

This vehicle is designed for operator only. **NO PASSENGER.**

Reverse Warning

WARNING

Reverse operation, even at low speeds, can cause loss of control resulting in serious injury or death. To avoid loss of control, always:

- Look behind before and while backing up.
- Avoid sharp turns.
- Shift to or from reverse only when stopped.
- Apply throttle slowly.

NOTE: For more information, see Owner's Manual.

If electric reverse:

- Machine stopped and engine at idle, push yellow button on LH control to reverse. Flashing light on dash indicates reverse operation.
- Push button again to return to forward.

No Passenger Warning/Fuel
Recommendation Label

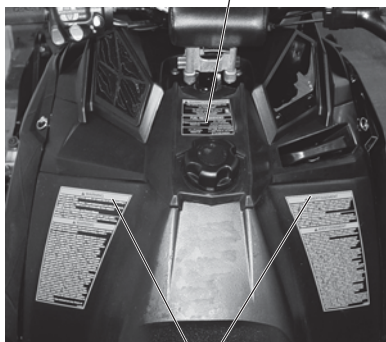

Reverse Warning

Safety Labels and Locations

Operation Warning

WARNING

- To avoid serious injury or death, read and understand all warnings and the Owner's Manual before operation. If manual is missing, contact a POLARIS dealer for a replacement.
- This vehicle is capable of high speeds. Buried objects or uneven terrain can cause loss of control. Reduce speed and use extreme caution when operating in unfamiliar terrain.
- Excessive speed, especially at night or with limited visibility, can result in insufficient time for you to react to terrain changes, to avoid unexpected obstacles, or to stop safely.
- Never consume alcohol or drugs before or while operating this vehicle.
- In an emergency, push down the Auxiliary Shut-Off Switch, located on the top of the throttle control assembly, to stop the engine. Then pull the brake lever to stop.
- Always wear an approved helmet, eye protection, and adequate clothing while operating this vehicle.
- This vehicle is designed for adult use only. Check local laws for age requirements.
- When operating with a passenger (on approved models only) reduce speed and allow extra space for steering and stopping. A passenger reduces your ability to control the vehicle.
- When operating on hard-packed snow, ice, or when crossing roads, steering and braking ability are greatly reduced. Reduce speed and allow extra space to turn or stop.
- To maintain vehicle control on ice or hard-packed surfaces, you should have a proper balance of ski carbides to track studs. See Owner's Manual for proper use of traction products.
- Repeated stops from high speed may cause fading or sudden loss of braking ability.
- Parking brake may relax when used for long periods. Do not leave brake engaged for more than five minutes.
- Before starting engine, check throttle, brake, and steering for proper operation. Make sure hood and side panels are latched. Be seated and in position to control the vehicle.



Operation
Warning

Oil injection system: Use unmixed fuel only. Check oil level when refueling.

FEATURES

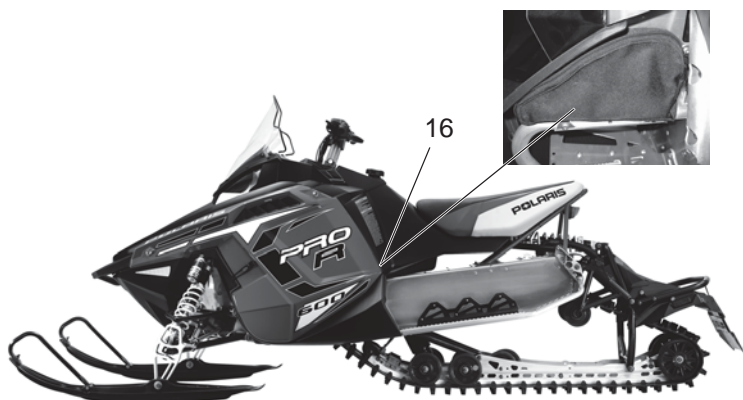
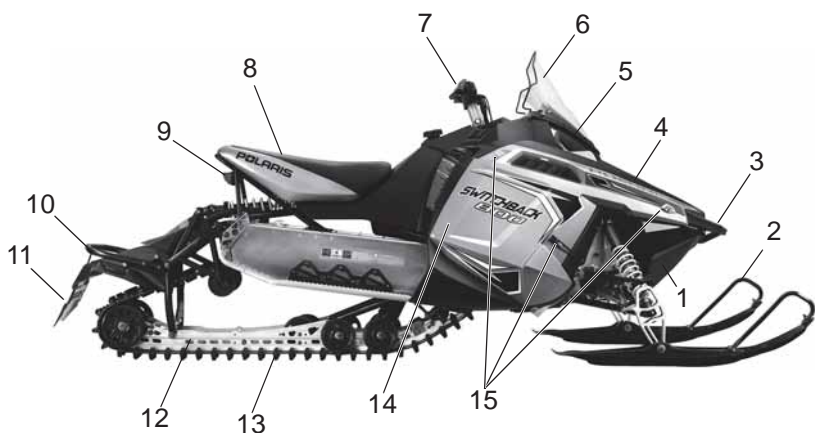

- | | |
|---------------------------|--------------------------|
| 1. Nosepan | 9. Taillight |
| 2. Skis | 10. Rear Bumper |
| 3. Front Bumper | 11. Snow Flap |
| 4. Hood | 12. Suspension |
| 5. Headlight | 13. Track |
| 6. Windshield (accessory) | 14. Side Panel |
| 7. Handlebar | 15. Side Panel Fasteners |
| 8. Operator Seat | 16. Tool Kit/Storage Bag |

FEATURES

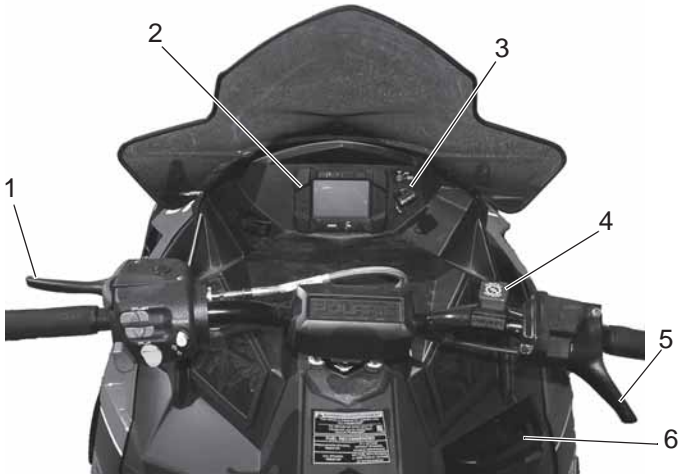

1. Brake Lever
2. MFD Gauge
3. Ignition Switch
4. Engine Stop Switch
5. Throttle Control
6. Recoil Starter Handle
7. Parking Brake Lock
8. Handlebar Grip Warmer Switch
9. Thumbwarmer Switch
10. Electronic Reverse Button
11. Mode/Set Switch
12. Headlight Dimmer Switch

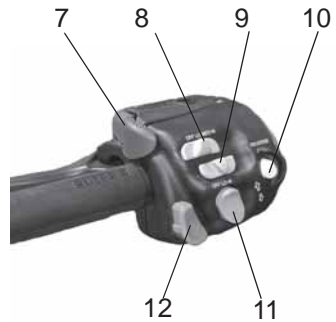

FEATURES

Adjustable Headlights

Move the headlight adjuster to the left to adjust the headlight beam upward. Move the adjuster to the right to adjust the beam downward.



Fuel Type Selection

Whenever using ethanol, MTBE or other forms of oxygenated gasolines, the fuel type designation setting must be changed to “Eth” in the gauge. When using the recommended 91 non-ethanol gasoline, always select the “91-non” setting.

Whenever in doubt of your fuel purchase, use the “Eth” setting as a safeguard.

Use the following procedure to change the fuel type designation in the gauge. Refer to the fuel type selection label located inside the left side panel.

1. Start the engine.
2. Lock the parking brake.
3. *Press and release* the SELECT button or SET switch until “FUEL” is displayed in the lower section of the gauge.
4. *Press and hold* the SELECT button or SET switch until the desired fuel type is displayed in the center of the screen.

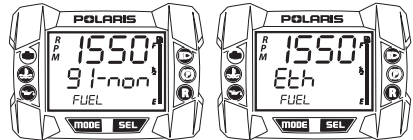
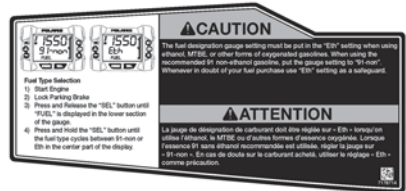

FEATURES

Detonation Elimination Technology (DET)

The DET system prevents damage to the engine from detonation by going into an engine protection mode whenever the DET system is active.

When *excessive* detonation is detected, the check engine light will illuminate and you may notice decreased engine performance and RPM when the DET system is activated. In most cases this is temporary and the operator does not need to take any action. The engine will return to its normal performance automatically.



If *severe* detonation occurs, the check engine light will begin to flash steadily and the gauge indicator will read “dET” (see illustration). The engine will enter a *limp home* mode and RPM will be limited to 6500 RPM. The engine will remain in this mode until it is shut down and restarted.

Check Engine Light	Indicates
Solid or Flickering	Excessive detonation detected
Steady Flashing	Severe detonation detected, RPM will be limited

FEATURES

Detonation Elimination Technology (DET)

The most likely causes of severe detonation are outlined in the troubleshooting table below.

DET Troubleshooting

Cause of DET Activation	Solution
Poor quality fuel	Replace with higher quality fuel
Incorrect ethanol/non-ethanol fuel type setting	Verify correct fuel type setting on gauge
Low fuel/no fuel in tank	Refuel with recommended fuel
Water in fuel	Replace with recommended fuel
Plugged fuel filter or tank pick-up sock	See your POLARIS dealer for service
Alcohol-based fuel additive used with Ethanol fuel	Do not add deicers or additives that contain any form of alcohol while using up to 10% ethanol fuel
Improper engine modifications	Do not modify the engine

Security System (Ignition Lock System)

Your snowmobile has an optional security function that can be activated by an authorized POLARIS dealer. If you have this feature activated, you can lock the ignition to prevent unauthorized use when leaving the snowmobile unattended. A locked system will limit engine speed to 3000 RPM, which prevents clutch engagement, and the snowmobile will not move when throttle is applied.

If you wish to use this system, see page 37 of the Instrument Cluster section for security system activation and operating instructions.

FEATURES

Instrument Cluster



The instrument cluster contains indicator lights and the rider information center. The information center can be controlled by either the MODE and SELECT buttons on the instrument cluster or by the MODE/SET switch on the left handlebar.

NOTICE: Certain products will damage the lens and other plastic surfaces. Do not use alcohol to clean the instrument cluster. Immediately clean off any gasoline that splashes on the instrument cluster.

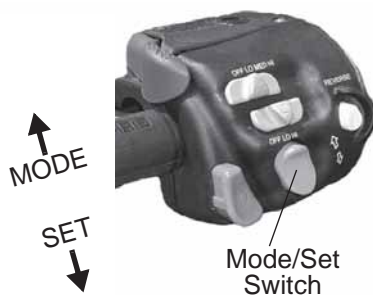

Instrument Cluster Indicators

Check Engine Indicator

This indicator appears if an EFI-related fault occurs. Do not operate the snowmobile if this warning appears. Serious engine damage could result. See your dealer. See page 44 for diagnostic code definitions.

Over-Temperature Indicator

This indicator illuminates to alert the operator that the engine is overheating. The operator should take action to cool the engine. See page 92. If the indicator flashes, continued operation could result in serious engine damage. Stop the engine *immediately*.

Low Oil Indicator

The low oil indicator light may flicker at times due to oil movement in the bottle, but when the light comes on and remains on, add the recommended oil before further operation. See page 73.

High Beam Indicator

The high beam indicator illuminates when the lights are set to high beam.

Parking Brake Indicator

This indicator illuminates when the parking brake is engaged. It will also illuminate when the service brake is in use. See page 64.

Reverse Indicator

This indicator flashes when the snowmobile is in reverse. See page 78.

FEATURES

Instrument Cluster

Rider Information Center

The rider information center is located in the instrument cluster. The center displays vehicle speed, engine speed, odometer, resettable trip meters (2), total engine hours of operation, fuel level, engine temperature and diagnostic display mode.

Setting changes must be made with the engine running or with the vehicle powered by an external DC power supply connector.

The information center is set to display standard units of measurement for distance and temperature. To change to metric units, see page 36.



Instrument Cluster

Rider Information Center

1. **Information Display Area** - This area displays either engine speed or vehicle speed (whichever is not displayed in the speed display), engine temperature and maximum vehicle speed. To change the display, see page 34.
 2. **Speed Display** - The speed display area displays either vehicle speed or engine speed. To change the display, see page 34.
 3. **Fuel Gauge** - The segments of the fuel gauge show the level of fuel in the fuel tank. When the last segment clears, a low fuel warning is activated. All segments including the fuel icon will flash. Refuel immediately.
- Tip:** If the fuel icon fails to display, an open or short circuit has occurred in the fuel sensor circuit. See your dealer.
4. **Odometer/Engine Hour Display** - This area displays the odometer, Trip A, Trip B and engine hours. To change the display, see page 35.
 5. **Battery Power** - This indicator illuminates when battery power is low.
 6. **Playback Icon** - The playback function allows the rider to record and play back engine speed, vehicle speed and throttle position sensor information for up to three minutes. The playback icon flashes while recording. See page 35.

FEATURES

Instrument Cluster

Rider Information Center

Speed Display Area

The speed display area displays either vehicle speed or engine speed. Vehicle speed is displayed in either miles per hour (MPH) or kilometers per hour (km/h). Engine speed is displayed in revolutions per minute (RPM).

1. To change which item displays, first make sure the information display area is set to display either engine speed or vehicle speed.
2. *Press and hold* the MODE button (on the instrument cluster) or the MODE switch (on the left handlebar) for three seconds.

Information Display Area

This area displays either engine speed or vehicle speed (whichever is not displayed in the speed display), engine temperature and maximum vehicle speed. To change the display, *press and release* the MODE button or the MODE switch until the desired item is displayed.

Instrument Cluster

Rider Information Center

Odometer/Engine Hour Display Area

This area displays the odometer, Trip A meter, Trip B meter and engine hours meter.

The odometer displays the total distance traveled by the vehicle since manufacture. Each trip meter records the distance traveled by the vehicle on a trip if the meter is reset before each trip. The engine hour meter displays the total hours the engine has been in operation since manufacture.

To change the display, *press and release* the SELECT button or the SET switch until the desired item is displayed.

To reset a trip meter, *press and hold* the SELECT button or the SET switch until the meter resets to zero.

Playback Function

The playback function allows the rider to record and play back engine speed, vehicle speed and throttle position sensor information for up to three minutes.

1. To begin recording, simultaneously *press and hold* the MODE and SELECT buttons on the instrument cluster for three seconds. The playback indicator will flash while the instrument cluster is recording.
2. To play back the recorded data, stop the vehicle and wait for engine speed to drop below clutch engagement.
3. Simultaneously *press and release* the MODE and SELECT buttons on the instrument cluster.
4. Applying the throttle will clear the display and return the instrument cluster to normal operation.

FEATURES

Instrument Cluster

Rider Information Center

Standard/Metric Display

The odometer and temperature displays can be viewed in either standard or metric units of measurement. Both displays change if units are changed. The new settings will remain until changed by the operator.

Change Method 1

1. *Press and release* the MODE button or MODE switch until engine temperature displays.
2. *Press and hold* the MODE button or MODE switch until the units change.

Change Method 2

1. *Press and release* the SELECT button or SET switch until the odometer displays.
2. *Press and hold* the SELECT button or SET switch until the units change.

Instrument Cluster

Rider Information Center

Security System (Ignition Lock System)

This system is an optional feature and will not function until it has been activated by your authorized POLARIS dealer. If you have this feature activated, you can lock the ignition to prevent unauthorized use when leaving the snowmobile unattended. A locked system will limit engine speed to 3000 RPM, which prevents clutch engagement, and the snowmobile will not move when throttle is applied.

If you wish to use this feature, you must complete all four tasks on the following pages to have your system activated and to change the security code to one of your own choosing.

FEATURES

Instrument Cluster

Rider Information Center

Security System (Ignition Lock System)

First Time Use of Your Security System

Perform all tasks in the order shown if you wish to activate and use the optional security system.

TASK 1: Activate the security system

See your authorized POLARIS dealer to have the optional security system feature activated in the electronic control unit (ECU).

TASK 2: Lock the System the First Time

1. Start the engine and lock the parking brake.
2. Press and hold the MODE and SEL buttons for 3 seconds, then release. SECURE OFF should be displayed. If not, repeat this step.
3. Wait until ENTER CODE displays, then press and release SEL to advance the digit. When "0" is displayed, press and release MODE to accept the digit. **TIP:** If the ENTER CODE screen exits due to inactivity, repeat step 2.
4. Press and release SEL to advance the second digit. When "0" is displayed, press and release MODE to accept the digit.
5. Press and release SEL to advance the third digit. When "0" is displayed, press and release MODE to accept the digit.
6. After accepting the third digit, view the display screen. SECURE ON displays if the system locks.

NOTE: The system is now *locked*.

7. You must now unlock the system. Proceed immediately to TASK 3.

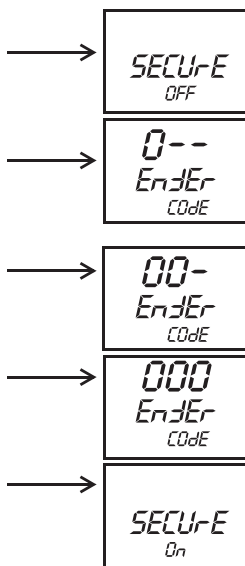

Instrument Cluster Rider Information Center Security System (Ignition Lock System)

First Time Use of Your Security System

TASK 3: Unlock the System

- When the engine is running, the display will alternate between SECURE ON and ENTER CODE. Wait until ENTER CODE displays, then press and release SEL to advance the digit. When "0" is displayed, press and release MODE to accept the digit.
- Press and release SEL to advance the second digit. When "0" is displayed, press and release MODE to accept the digit.
- Press and release SEL to advance the third digit. When "0" is displayed, press and release MODE to accept the digit.
- After accepting the third digit, view the display screen. SECURE OFF displays if the system unlocks.

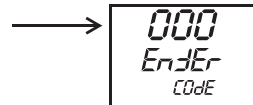
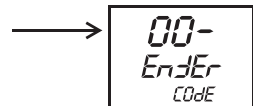
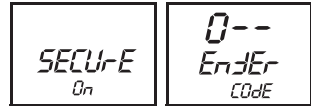

NOTE: The system is now *unlocked*.

- You must now enter a new security code. Proceed immediately to TASK 4.

TASK 4: Enter Your New Security Code

- Immediately after locking and unlocking the system, and while SECURE OFF is displayed, press and release the MODE button to bring up the ENTER CODE screen.
- When ENTER CODE displays, use the SEL and MODE buttons to select and accept each digit of a new personal security code.
- After accepting the third digit, view the display screen. The new code and CODE SET will display if the system accepted your new code. You will not see this display again.

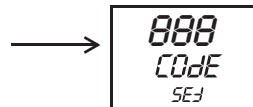

NOTE: Your new code is now set. The system is NOT locked.

- Record your new security code in a safe place for future reference.

Record your new personal security code here: _____

TIP: If you lose your personal security code, see your dealer to have the code reset to "000". Then perform TASK 2 through TASK 4 to change the code to one of your own choosing.

FEATURES

Instrument Cluster

Rider Information Center

Security System (Ignition Lock System)

Locking the System With Your Personal Security Code

1. Start the engine and lock the parking brake.
2. Press and hold the MODE and SEL buttons for 3 seconds, then release. SECURE OFF should be displayed. If not, repeat this step.
3. Wait until ENTER CODE displays, then press and release SEL to advance the digit. When the first digit of your security code is displayed, press and release MODE to accept the digit.

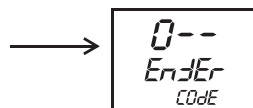
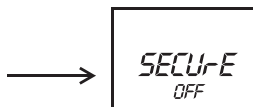

TIP: If the ENTER CODE screen exits due to inactivity, repeat step 2.

4. Continue to use SEL and MODE to select and accept the remaining two digits of the code.
5. After accepting the third digit, view the display screen. SECURE ON displays if the system locks. Engine speed is now limited and the snowmobile cannot be driven.

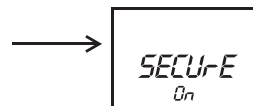

TIP: When the engine is running, the display will alternate between SECURE ON and ENTER CODE.

6. If BAD CODE displays, the screen will then return to the ENTER CODE screen. Repeat steps 3-5 to re-enter the security code.

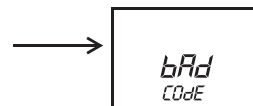

Instrument Cluster Rider Information Center

Security System (Ignition Lock System)

Unlocking the System With Your Personal Security Code

1. When the engine is running, the display will alternate between SECURE ON and ENTER CODE. Wait until ENTER CODE displays, then press and release SEL to advance the digit. When the first digit of your security code is displayed, press and release MODE to accept the digit.

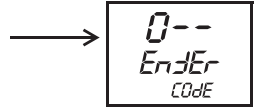

TIP: When the system is locked and engine temperature is above 120° F (49° C), the correct password must be entered within 60 seconds or the engine will shut down.

2. Continue to use SEL and MODE to select and accept the remaining two digits of the code.
3. After accepting the third digit, view the display screen. SECURE OFF displays if the system unlocks.
4. Re-enter your code if BAD CODE displays.



NOTE: The system is now *unlocked*.

FEATURES

Instrument Cluster

Rider Information Center

Security System (Ignition Lock System)

Changing to a New Security Code

Any time you wish to change your current security code to a new code, perform TASK 2 through TASK 4 of the First Time Use of Your Security System procedure beginning on page 38. Instead of using the factory default code “000” in TASK 2 and TASK 3, use your current security code.

Security System Access Quick Reference

Now that you have become familiar with the procedure for locking and unlocking the system, use the chart below as a quick reference.

Security System Access Quick Reference Chart	
Action	Result
Start engine + Lock parking brake + Press and hold both MODE + SELECT (SEL)	Displays ENTER CODE (to lock the system)
Press SELECT (SEL)	Advances a digit on the ENTER CODE screen
Press MODE	Accepts a digit and displays the next digit position (if any remain) on the ENTER CODE screen or Opens ENTER CODE screen if MODE is pressed immediately after locking and unlocking the system (to change your security code)

Instrument Cluster Rider Information Center Diagnostic Display Mode

The diagnostic display mode is for informational purposes only. Please see your POLARIS dealer for all major repairs.

The diagnostic mode is accessible only when the check engine warning indicator is illuminated *and* a diagnostic code is active.

Do not stop the engine if you want to view the active code (failure code). Active codes cannot be retrieved if power is interrupted to the instrument cluster. The codes will become inactive codes if power is interrupted. Inactive codes are stored in the history of the unit. Please see your POLARIS dealer to retrieve inactive codes.

Use the following procedure to view active codes.

1. Do not stop the engine.
2. With the brake engaged, press and release the SELECT button or SET switch to toggle to the diagnostic display mode. When a code is active, the diagnostic display mode will appear immediately following the engine hour display.

TIP: When the diagnostic mode is displayed, the check engine warning indicator will begin to flash.

3. A set of two numbers will appear in the display.
 - The 2-6 digit suspect parameter number (SPN) in the information display area indicates which component is generating the fault code.
 - The 1-2 digit failure mode indicator (FMI) number in the odometer area indicates the fault mode, such as open or short circuit.
4. More than one fault may be active. Press and hold the MODE button or MODE switch for two seconds to toggle to the next active code. Repeat until all codes are retrieved.
5. See page 44 for code definitions and failure descriptions.

FEATURES

Instrument Cluster

Rider Information Center

Diagnostic Display Code Definitions

Open Load: There is a break in the wires that lead to the item listed in the chart (injector, fuel pump, etc.), or the item has failed.

Short-to-Ground: The wire is shorted to ground between the electronic control unit and the item listed in the chart.

Shorted Load: The wires leading to the item listed in the chart are shorted together, or the item has shorted internally.

Short-to-Battery: The wire leading from the item listed in the chart to the electronic control unit is shorted to a wire at battery voltage.

Diagnostic Codes			
Component	Condition	SPN	FMI
Throttle Position Sensor	Voltage Too High	51	3
	Voltage Too Low		4
	Abnormal Rate of Change		10
Vehicle Speed Sensor	Data Erratic, Intermittent or Missing	84	2
Intake Air Temperature Sensor	Voltage Too High	105	3
	Voltage Too Low		4
Barometric Pressure Sensor	Voltage Too High	108	3
	Voltage Too Low		4
Engine Temperature Sensor	Voltage Too High	110	3
	Voltage Too Low		4
	Temperature Too High		16
	Engine Overheat Shutdown		0
	Temperature Above Normal Range		15
Alternator Power Supply Potential (DC Chassis Voltage)	Voltage Too High	167	3
	Voltage Too Low		4
Exhaust Temperature Sensor	Voltage Too High	173	3
	Voltage Too Low		4

Instrument Cluster Rider Information Center

Diagnostic Display Code Definitions

Diagnostic Codes			
Component	Condition	SPN	FMI
ECU Memory	Checksum/CRC Error	628	13
Injector 1 (MAG) (Port Injector)	Driver Circuit Open/Grounded	651	5
	Driver Circuit Short to B+		3
Injector 2 (PTO) (Port Injector)	Driver Circuit Open/Grounded	652	5
	Driver Circuit Short to B+		3
Knock Sensor 1	Voltage Too Low	731	4
Ignition Coil Primary Driver 1 (MAG)	Driver Circuit Open/Grounded	1268	5
Fuel Pump Driver Circuit	Driver Circuit Open/Grounded	1347	5
Knock Level Cylinder 1 (MAG)	Maximum Detonation Correction Limit Reached	1352	0
	Knock Above Critical Level		16
Knock Level Cylinder 2 (PTO)	Maximum Detonation Correction Limit Reached	1353	0
	Knock Above Critical Level		16
Sensor Supply Voltage 1 (TPS/TMAP Sensor Power)	Voltage Too Low	3509	4
Sensor Supply Voltage 2 (Ground Speed Sensor)	Voltage Too Low	3510	4
ECU Output Supply Voltage 2 (Injection Supply PWR)	Voltage Too High	3598	3
	Voltage Too Low		4
Throttle Release Signal	Voltage Too High	520194	3
	Voltage Too Low		4
	Throttle Stuck		7
Chassis Relay	Driver Circuit Open/Grounded	520208	5
	Driver Circuit Short to B+		3
Exhaust Valve Solenoid	Driver Circuit Grounded	520215	5
	Driver Circuit Short to B+		3
Injector 1 (MAG) (Case Injector)	Driver Circuit Open/Grounded	520216	5
	Driver Circuit Short to B+		3
	Driver Circuit Grounded		4
Injector 2 (PTO) (Case Injector)	Driver Circuit Open/Grounded	520217	5
	Driver Circuit Short to B+		3
	Driver Circuit Grounded		4
Fuel Type Selected	Voltage Too High	524007	3
	Voltage Too Low		4
	Signal Out Of Range		2

THE PERFECT FIT

Suspension Quick Set-Up Guide

The suspension on this snowmobile is incredibly easy to adjust to rider weight and riding style. Just remember three simple steps:

1. Set up rear shock spring preload for rider weight.
2. Adjust the *rear spring* to tune *vehicle balance* (ski pressure and weight transfer).
3. Adjust *shock clickers* to tune *ride quality* (stiffer or softer ride).

The following Quick Set-Up Guide walks you through what you need to know to get started, and additional detail is available on the pages immediately following the guide. See pages 48-49 for factory and initial suspension charts for the standard spring as well as for accessory springs that are available for heavier or lighter riders.

Step 1: Set up rear shock spring preload for rider weight.

Before riding for the first time, use the gauge supplied with your snowmobile to adjust rear spring preload to the appropriate setting for actual rider weight.

Position the narrow end of the gauge flush with the spring retainer. Turn the spring until the rider's weight setting aligns with the junction of the shock body and end cap.

Make no other suspension adjustments at this time. Test ride the snowmobile in various terrain to fully experience the existing suspension settings before making adjustments.

Spring Retainer/Adjustment Nut





Shock Body/End Cap Junction

THE PERFECT FIT

Suspension Quick Set-Up Guide

Step 2: Adjust the rear spring to tune vehicle balance.

After the initial test ride, make adjustments to the rear shock spring to improve vehicle balance. Increasing preload will increase ski pressure and result in less weight transfer, flatter cornering and more precise steering response. Decreasing preload will decrease ski pressure and result in more weight transfer, or less weight on the skis when accelerating.

Ride Experience		Adjustment
Too much weight transfer •Ski pressure is too light •Skis push		Turn rear shock spring retainer clockwise (see page 55)
Too little weight transfer •Ski pressure is too heavy •Steering is heavy		Turn rear shock spring retainer counter-clockwise (see page 55)

Step 3: Adjust shock clickers for ride quality.

After making spring adjustments, adjust shock clickers to control bottoming. Turning a clicker counter-clockwise decreases damping for a softer ride. Turning a clicker clockwise increases damping for a stiffer ride and less bottoming.

NOTICE: Always adjust the clicker at least one click below full stiff (full clockwise) or shock damage will occur.

Test ride the snowmobile and continue making spring and clicker adjustments until you achieve the perfect ride.

TIP: Initially, heavier riders may want to set the shock clickers 2-4 clicks higher than lighter riders.

Ride Experience	Clicker to Adjust	Adjustment	See Page
Bottoming in the IFS	IFS shock - after 150 mi. (240 km) break-in	Clockwise	52
Bottoming in the center	Front track shock	Clockwise	54
Bottoming in the rear	Rear shock	Clockwise	55
No bottoming, but ride is harsh in front or rear	IFS shock (after break-in), Front track shock, Rear shock	Counter-clockwise	52 54 55
Harsh in chatter/bumps	Front track shock, Rear shock	Counter-clockwise	54 55

THE PERFECT FIT

Suspension Quick Set-Up Guide

Accessory rear shock springs are available for riders of different weights. A corresponding gauge is available for each spring type.

The gauge provided with your snowmobile is calibrated for the stock spring, which should be used by most riders. Do not change springs unless your weight is at the very high or very low end of the stock spring rider weight range and adjustments to the factory-installed spring have not perfected your ride.

In the following spring guide, the dimension is as measured from the spring retainer to the junction of the shock body and end cap. See page 46.

Spring Guide											
Stock Spring				Accessory 120 Spring				Accessory 260 Spring			
				See your POLARIS dealer to order an accessory spring and the gauge calibrated for that spring.							
Rider Weight		Dimension		Rider Weight		Dimension		Rider Weight		Dimension	
lbs.	kg	in.	cm	lbs.	kg	in.	cm	lbs.	kg	in.	cm
120	54	1.5 Min	3.81	90	41	2.375	6.03	240	109	2.125	5.40
130	59			95	43	2.5	6.35	255	116	2.25	5.72
140	64	1.75	4.44	100	45	2.625	6.67	270	122	2.375	6.03
150	68			105	48	2.75	6.99	280	127	2.5	6.35
160	73	2.0	5.08	110	50	2.875	7.3	295	134	2.625	6.67
170	77			115	52	3	7.62	310	141	2.75	6.99
180	82	2.125	5.39	120	54	3.125	7.94	320	145	2.875	7.3
190	86			125	57	3.25	8.26	335	152	3 Max	7.62
200	91	2.25	5.71	130	59	3.375	8.57	-	-	-	-
210	95			135	61	3.5	8.89	-	-	-	-
220	100	2.50	6.35	140	64	3.625	9.21	-	-	-	-
230	104			150	68	3.75	9.53	-	-	-	-
240	109	2.75 Max	6.98	155	70	3.875 Max	9.84	-	-	-	-
260	118			-	-	-	-	-	-	-	-

THE PERFECT FIT

Suspension Quick Set-Up Guide

Factory Suspension Settings	
IFS and Front Track Shock	
IFS Shock Clicker	6 clicks clockwise from full soft
IFS Shock Spring Preload	From body end to spring: FOX shocks 3.75 inches (9.52 cm) PRO-R shocks 3.00 inches (7.62 cm)
Front Track Shock Clicker	2 clicks clockwise from full soft
Front Track Shock Spring Preload	1.375 inches (3.49 cm) from body end to spring
Stock Rear Spring	
Rear Shock Clicker	4 clicks clockwise from full soft
Rear Shock Spring Preload	See Optional Spring Guide (page 48)

Accessory Spring Recommended Initial Settings	
Accessory 120 Rear Spring	
Rear Shock Clicker	4 clicks clockwise from full soft
Rear Shock Spring Preload	See Optional Spring Guide (page 48)
Accessory 260 Rear Spring	
Rear Shock Clicker	4 clicks clockwise from full soft
Rear Shock Spring Preload	See Optional Spring Guide (page 48)

POLARIS recommends that riders use this Quick Set-Up Guide to make any adjustments for rider weight and trail conditions. If additional tuning is needed after you have exhausted all possible adjustments to the rear shock spring and clicker, refer to the information on the following pages of this manual.

THE PERFECT FIT

Front Suspension Adjustments

Independent Front Suspension (IFS)

Factory settings, combined with user adjustments to the rear shock spring, should be all that's necessary to provide the best riding experience for most riders. If all rear shock spring adjustments have been exhausted and rider weight is at the very high or very low weight range for the stock spring, additional adjustments are possible to the IFS.

Settings will vary from rider to rider, depending on rider weight, vehicle speed, riding style, and trail conditions. We recommend starting with factory settings and then customizing each adjustment individually to suit rider preference. The snowmobile should be methodically tested, one change at a time, under the same conditions (trail and snow conditions, vehicle speed, riding position, etc.) after each adjustment until the best ride is achieved.

Break in the suspension for about 150 miles (240 km) before making adjustments to the front suspension.

IFS Components

1. Skis
2. Front shocks and springs
3. Rod ends
4. A-arms

IFS Adjustment Options

- Front shock spring preload
- Compression damping
- Optional springs
- Optional shock valving

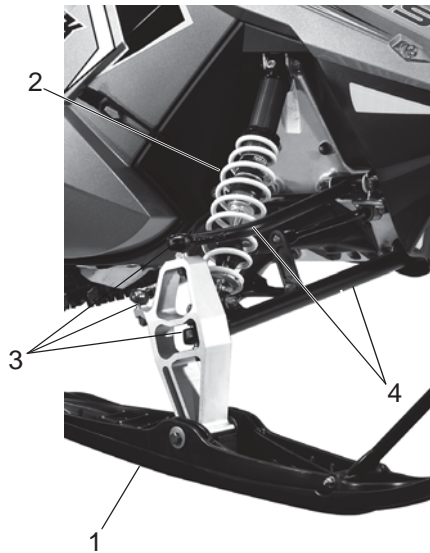

Front Suspension Adjustments

IFS Shock Spring Preload

Increasing spring preload will increase ski-to-ground pressure. Decreasing spring preload will decrease ski-to-ground pressure. When adjusting, be sure the springs on both the left and right sides of the machine are at the same adjustment.

Always perform shock spring preload adjustments with the weight of the vehicle removed from the shock and with the shock at full extension.

To change shock spring preload, grasp the spring retainer and rotate it.

Initial IFS Preload Setting (from body end to spring)	
FOX shocks	3.75 inches (9.5 cm)
PRO-R premium shocks	3.00 inches (7.6 cm)

Increasing the spring preload too much may adversely affect the handling of the snowmobile and the performance of the suspension. Never exceed one inch (2.54 cm) of preload beyond the factory settings.

NOTICE: When decreasing preload, make sure at least two turns of preload are holding the spring between the retainer on the top of the shock and the threaded spring preload adjuster nut on the shock body. Failure to do so could cause the retainer to fall off when the suspension is fully extended.

TIP: Other spring options are available. Please see your POLARIS dealer.

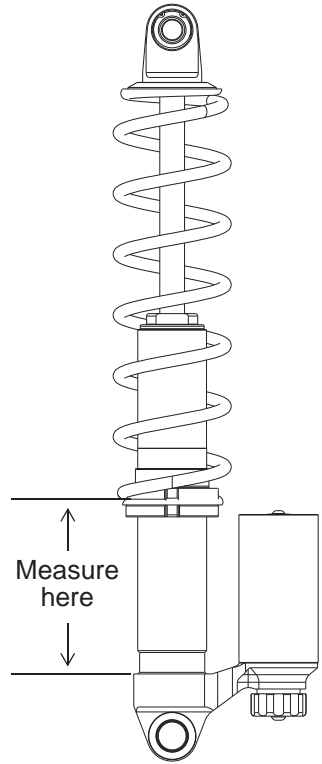

THE PERFECT FIT

Front Suspension Adjustments

IFS Shock Compression Damping

Make adjustments to the shock clickers to control bottoming. Make the adjustments in 1-to-2-click increments, then test ride. Repeat the adjustment until the desired result is achieved.

TIP: Initially, heavier riders may want to set the shock clickers 2-4 clicks higher than lighter riders.

The standard clicker setting is 6 clicks from the softest position.

- Turn the clicker clockwise for a stiffer ride (as viewed from the top).
- Turn the clicker counter-clockwise for a softer ride.

When adjusting, we recommend that you turn the clicker only one or two clicks, then test ride. Always adjust both shocks equally.

Shock Valving

Some shocks can be revalved if spring preload alone isn't sufficient and further adjustment is desired to control suspension stiffness. Please see your POLARIS dealer.

WARNING! Changing shock valving requires special tools and a sound knowledge of mechanical theory, tool use, and shop procedures to perform the work safely and correctly. Shocks contain high-pressure nitrogen gas. Use extreme caution when handling high-pressure service equipment. We recommend that this work be performed by a POLARIS dealer.



Rear Suspension Adjustments

Rider weight, riding style, trail conditions, and vehicle speed all affect suspension action.

Each rear suspension can be adjusted to suit rider preference and deliver excellent performance for a given set of conditions. However, all suspension designs and adjustments involve a compromise, or trade-off. For example, a suspension set up for snowcross racing would provide a very stiff ride on the trail. A suspension set up for trail riding would bottom out harshly on a snowcross course.

Additional adjustments should be made after initial setup. Make adjustments to one area at a time so you can evaluate the change. For further assistance, see your dealer.

Suspension Performance Tips

- Rider weight usually determines the position at which the spring preload should be set. However, this may vary with riding style. With a little experimentation, each rider can find a preferred set-up.
- In deep snow, a new rail slide will offer improved performance over worn rail slide. It can also improve top speed.
- When riding on ice or hard-packed snow, adding a set of bogie wheels to the rail may enhance the snowmobile's performance. Bogie wheel kits are available from your dealer.

Track Tension

Track adjustment is critical for proper handling. Always maintain correct tension and alignment. Refer to the track tension maintenance section beginning on page 106.

THE PERFECT FIT

Rear Suspension Adjustments

Front Track Shock Compression Damping

Make adjustments to the shock clicker to control bottoming. Make the adjustments in 2-click increments, then test ride. Repeat the adjustment until the desired result is achieved.

TIP: Initially, heavier riders may want to set the shock clickers 2-4 clicks higher than lighter riders.

The standard clicker setting is 2 clicks from the softest position.

- Turn the clicker clockwise for a stiffer ride.
- Turn the clicker counter-clockwise for a softer ride.

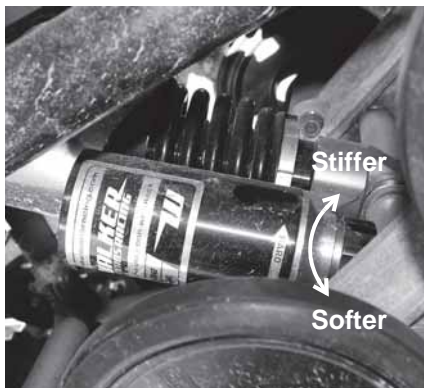

Front Track Shock Spring Preload

Always perform shock spring preload adjustments with the weight of the vehicle removed from the shock and with the shock at full extension.

Increasing spring preload will *decrease* ski-to-ground pressure. Decreasing spring preload will *increase* ski-to-ground pressure.

The initial preload setting is 1.375 inches (3.49 cm) from body end to spring. To change shock spring preload, grasp the spring retainer and rotate it.

Increasing the spring preload too much may adversely affect the handling of the snowmobile and the performance of the suspension. Never exceed one inch (2.54 cm) of preload beyond the factory settings.

When decreasing preload, make sure at least two turns of preload are holding the spring between the retainer on the top of the shock and the threaded spring preload adjuster nut on the shock body. Failure to do so could cause the retainer to fall off when the suspension is fully extended.

TIP: Other spring options are available. Please see your POLARIS dealer.



Rear Suspension Adjustments

Rear Shock Spring Preload Settings

Make adjustments to the rear shock spring to tune vehicle balance. Always perform shock spring preload adjustments with the weight of the vehicle removed from the shock and with the shock at full extension.

Increasing preload will increase ski pressure and result in less weight transfer and flatter cornering and more precise steering response. Decreasing preload will decrease ski pressure and result in more weight transfer, or less weight on the skis when accelerating.

Turn the spring retainer up to one turn from the initial setting, then test ride. Repeat the adjustment in one-turn increments until the desired result is achieved.

Increasing the spring preload too much may adversely affect the handling of the snowmobile and the performance of the suspension. Never exceed one inch (2.54 cm) of preload beyond the factory settings.

When decreasing preload, make sure at least two turns of preload are holding the spring between the retainer on the top of the shock and the threaded spring preload adjuster nut on the shock body. Failure to do so could cause the retainer to fall off when the suspension is fully extended.

Rear Shock Clicker

Make adjustments to the shock clicker to control bottoming, chatter and general riding comfort. Make the adjustments in 2-click increments, then test ride. Repeat the adjustment until the desired result is achieved.

TIP: Initially, heavier riders may want to set the shock clickers 2-4 clicks higher than lighter riders.

The standard clicker setting is 4 clicks from the softest position.

- Turn the clicker clockwise for a stiffer ride.
- Turn the clicker counter-clockwise for a softer ride.



THE PERFECT FIT

Handlebar Adjustments

Handlebar Position

1. Loosen the four bolts on the bottom of the adjuster block. If necessary, pry the blocks apart with a screwdriver.
2. Adjust the handlebar forward or rearward to the desired position.
3. Tighten the bolts. Torque the bolts to 13-16 ft. lbs. (18-22 Nm).

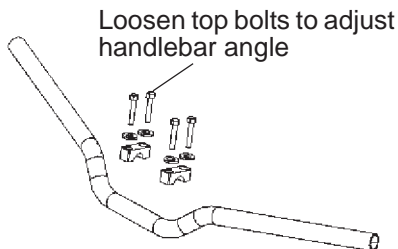

Handlebar Angle

1. Loosen the four bolts on the top of the adjuster block. If necessary, pry the blocks apart with a screwdriver.
2. Adjust the handlebar forward or rearward to the desired angle. Be sure handlebars, brake lever and throttle lever operate smoothly and do not hit the gas tank, windshield or any other part of the machine when turned fully to the left or right. If necessary, loosen the set screws for the left and right controls, rotate the controls *slightly*, then tighten the set screws to the proper torque.

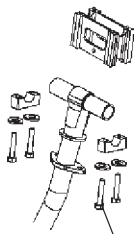

NOTICE: Do not stretch wires while adjusting the controls. Stretching the wires could damage the handwarmers.

- **Right control torque: 27 in. lbs. (3.05 Nm) +/- 10%.**
 - **Left control torque: 24 in. lbs. (2.7 Nm) +/- 10%.**
3. Tighten the bolts. Torque the bolts to 13-16 ft. lbs. (18-22 Nm).

Accessories

POLARIS offers a wide range of accessories for your snowmobile to help make each ride more enjoyable.

Use only POLARIS parts and accessories on your POLARIS snowmobile. Use of unapproved parts and accessories may result in:

- Non-compliance with government/industry requirements
- Voiding of warranty
- Injury to self or others

This applies, but is not limited to the following areas: brakes, clutches, fuel systems, internal engine components and exhaust systems. Exhaust systems are critical safety areas that must use approved POLARIS parts. Please see your POLARIS dealer for service.

THE PERFECT FIT

Traction Products

Studs

The track is not warranted by POLARIS if studs have been installed. Track warranties are also void if track damage or failure results from the use of any non-POLARIS traction products. Use only POLARIS-approved traction products on your snowmobile.

If you choose to install studs, stud length must not exceed 1.45 inches (37 mm) for a factory-installed track.

See your dealer about installing studs and/or carbides.

NOTICE: Always install wear strips before installing studs. Failure to install wear strips may result in cooler or tunnel damage. See page 59.

Never add shims to the wear strip. Track damage will result because of lack of clearance between upper carrier wheels and track.

Use of studs longer than the recommended length on snowmobiles equipped with center coolers will result in center cooler damage or damage to the tunnel.

Track studding will enhance braking control on hard-packed snow or ice, but extreme caution is still required on such surfaces. Steering ability may be reduced on hard-packed snow or ice.

When studded tracks are used, increased wear to the brake pads will result from increased braking. Extended-wear brake pad kits are available. See your dealer.

NOTICE: Aggressive studding patterns may require grinding protruding stud bolts flush to prevent idler wheel damage. Maintain track tension on studded tracks on the tight side of the spec to prevent heat exchanger damage. The center of the stud must be at least 1 1/8 inches (2.9 cm) from the outside edge of the track.

Before equipping your snowmobile with traction products, be aware of the laws in your area pertaining to the use of traction products.

Traction Products

Carbide Skags

A skag is a replaceable bar attached to the underside of the ski to assist in turning the snowmobile and to prevent ski wear caused by contact with roads and other bare terrain. Use carbide skags with studded tracks to help maintain proper vehicle steering and control. See page 111.

If your snowmobile has carbide skags, it may be necessary to add track studs to maintain proper vehicle control. Maintain a proper balance between the number of studs and the length of carbide on the skags (the more studs you use, the longer the carbide on the skags should be). See your dealer's track studding chart.

Wear Strips

To avoid excessive tunnel wear, tunnel wear strips must be installed whenever track studding is used. Wear strips are designed for a specific stud length.

See your dealer's studding chart for recommended traction accessories.

NOTICE: Whenever wear strips are relocated, be sure there's adequate stud clearance to the heat exchangers. Lack of clearance may result in damage to heat exchangers.

PRE-RIDE INSPECTIONS

Pre-Ride Checklist

Inspect all items on the checklist for proper operation or condition before each use of the snowmobile. Procedures are outlined on the referenced pages.

Item	See Page
Drive Belt Condition	101
Steering System	65
Recoil Rope	65
Coolant Level	91
Chaincase Oil Level	86
Injection Oil Level	73
Parking Brake Lock/Brake Lever/Brake System	63, 64, 96
Auxiliary Shut-Off Switch (Engine Stop Switch)	66
Ignition Switch	66
Headlight/Taillight/Brakelight	66
Suspension Mounting Bolts	61
Skags (Wear Bars)	111
Ski Saddle and Spindle Bolts	61
Hood and Side Panel Fasteners	85
Throttle Lever/Safety Switch	74, 75
Rear Wheel Idler Bolts	107
Tether Switch/Strap (if equipped)	66
Track Alignment/Condition	65, 108
Rail Slide Condition	112

PRE-RIDE INSPECTIONS

Pre-Ride Suspension Inspection

Loose nuts and bolts can reduce your snowmobile's reliability and cause needless repairs and down time. Before beginning any snowmobile trip, a visual inspection will uncover potential problems. Check the following items on a weekly basis or before any long trip.‘

Item	See Page
Check suspension mounting bolts for tightness.	See Dealer
Check rear idler wheel bolts for tightness.	107
Check rear idler adjusting bolt locknuts for tightness.	--
Check front torque arm limiter strap condition.	--
Check rail slide condition.	112
Check track tension.	106
Check ski runner/skag condition.	111
Check ski spindle bolts for tightness.	109
Check tie rod end nuts for tightness.	--

PRE-RIDE INSPECTIONS

Before Starting the Engine

Before starting the engine, always refer to all safety warnings pertaining to snowmobile operation. Never start the engine without checking all vehicle components to be sure of proper operation.

WARNING! Operating the vehicle with worn, damaged, or malfunctioning components could result in serious injury or death. Never start the engine without checking all vehicle components to be sure of proper operation.

Read and Understand Your Owner's Manual

Read the Owner's Manual completely and refer to it often. The manual is your guide to safe and enjoyable snowmobiling experience.

Throttle Lever

The throttle and brake are the primary controls of your snowmobile. Always make sure both are functioning properly.

Squeeze the throttle lever to make sure it compresses evenly and smoothly. When released, the lever should immediately return to the idle position without binding or hesitation. If the throttle does not function smoothly, or if you discover excessive lever freewheel, **DO NOT** start the engine. Have the throttle serviced immediately.

Throttle Safety Switch

Test the throttle safety switch system before the snowmobile is operated. See page 74.

PRE-RIDE INSPECTIONS

Before Starting the Engine

Brakes

Always check the following items for proper operation before starting the engine.

Brake Lever Travel

Squeeze the brake lever. It should move no closer to the handgrip than 1/2 inch (1.3 cm). A smaller distance indicates low brake fluid level or air in the hydraulic system. Refer to the brake bleeding information on page 98 or see your dealer for service.

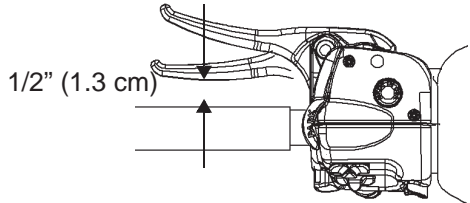

Lever Feel

If the brake lever feels “spongy” when squeezed, check the brake fluid level and condition. Add fluid as needed. See page 97.

WARNING! Continued use of “spongy” brakes may cause a complete loss of brakes, which could result in serious injury or death. Always have the brakes serviced at the first sign of sponginess.

PRE-RIDE INSPECTIONS

Before Starting the Engine

Parking Brake Lever Lock

Use the parking brake lever lock only when you want the snowmobile to remain stationary; for example, when parked on an incline for a period of five minutes or less.

1. Brake Lever
2. Parking Brake Lever Lock
3. Master Cylinder Reservoir/ Cover
4. Fluid Level Indicator



Lock Engagement

To engage the lock, squeeze the brake lever tightly and push forward on the lock. Hold the lock forward while releasing the brake lever.

TIP: If the brake lever is squeezed tightly enough, the lock will move freely into place. Do not force the lock or it may break.

The parking brake light will illuminate if the parking brake lever lock is set while the engine is running. It will also illuminate when the service brake is in use. If the parking brake light does not come on when the parking brake or service brake is in use, have it serviced by your dealer.

Lock Release

To release the lock, squeeze the brake lever tightly. The lock will return to the unlocked position.

WARNING! If the parking brake lever lock is partially or entirely engaged while riding, the brakes may overheat, resulting in brake damage. In extreme cases it could cause a fire, which could result in serious injury or death. Always ensure that the lever lock is completely disengaged before operating the snowmobile.

PRE-RIDE INSPECTIONS

Before Starting the Engine

Steering System

WARNING! Ice and snow build-up may interfere with the steering of your snowmobile, resulting in serious injury or death. Keep the underhood area free of snow and ice.

Before driving, manually turn the skis to the left and right to be sure ice and snow are not interfering with full left and right steering. If difficulty is encountered, remove ice and snow build-up that may be obstructing the steering linkage.

Track

Track damage or failure caused by operation on ice or poor lubrication conditions voids the track warranty.

WARNING! Operating the snowmobile with a damaged track increases the possibility of track failure, which could cause loss of control resulting in serious injury or death. Always inspect the track for damage before using the vehicle.

WARNING! Use of traction products such as studs increases the possibility of track damage and/or failure. Driving at high speeds for extended periods of time in marginal lubrication could severely damage track rods, break track edges, and cause other track damage. Examples of marginal lubrication would include frozen bodies of water without snow cover, icy trails, and no-snow conditions.

Side Panel Fasteners

The side panels of the snowmobile protect the operator from moving parts. Never operate the snowmobile with the side panels open or removed.

Seat Latches

If your snowmobile is equipped with a removable seat, ensure that the seat is properly installed and securely latched before each use of the snowmobile.

Recoil Rope

Inspect the recoil rope and handle for excessive wear, and make sure the knot securing the rope inside the handle is secure. If excessive wear is found, see your POLARIS dealer for replacement.

PRE-RIDE INSPECTIONS

Start the Engine and Check

Before starting the engine, always refer to all safety warnings pertaining to snowmobile operation. Never engage the starter when the engine is running. Never start the engine without checking all vehicle components to be sure of proper operation. See Before Starting the Engine beginning on page 62.

Engine Stop Switch

Check the auxiliary shut-off switch for proper operation. Push the switch down to stop the engine. Pull it up to allow restarting.

Ignition Switch

Make sure the engine stops when the ignition switch is turned to OFF.

Tether Switch (if equipped)

If your snowmobile has a tether switch, remove the tether from the switch to make sure the engine stops immediately.

Lighting

Check the headlight (high and low beam), taillight, and brake light. Replace burned out lamps before operating.

Mirrors (if equipped)

Adjust the mirrors so they can be used to their full advantage.

Operating Area

Before driving away, check your surroundings. Be aware of obstacles and make sure bystanders are a safe distance from the snowmobile.

Starting the Engine

NOTICE: Engaging the starter when the engine is running WILL result in serious engine damage, especially if the snowmobile is in reverse. Never engage the starter when the engine is running.

1. Turn the key to the ON position.
2. Pull the engine stop switch up to the RUN position.
3. If equipped with electric start, turn the key to START to crank the engine. Release the key to the ON position when the engine starts.
4. If not equipped with electric start, grasp the starter handle and pull slowly until the recoil engages; then pull abruptly to crank the engine.

TIP: Don't pull the starter rope to the fully extended position and don't allow it to snap back into the housing. Damage may result.

5. If the engine does not start after several attempts, slightly depress the throttle (no more than 1/4 inch (6 mm) open) while cranking the engine. When the engine starts, *immediately* release the throttle.

CAUTION! To avoid injury and/or engine damage, do not operate the electric starter or pull-rope starter while the engine is running.

NOTICE: Operating the vehicle immediately after cold starting could cause engine damage. Allow the engine to warm up for several minutes before operating the vehicle. If cold drive-away is attempted, the engine RPM may stumble slightly to protect the engine.

Restarting an Engine

If the rider stops the engine by pushing the engine stop switch down, restart the engine using the normal starting procedure. If the engine fails to start using the normal procedure:

1. Push the engine stop switch down to the OFF position.
2. Turn the key to the OFF position.
3. With both switches OFF, squeeze and hold the throttle in the wide open position.
4. Crank the engine several times to draw fresh air through the engine.
5. Release the throttle.
6. Restart the engine using the normal starting procedure.

OPERATION

Break-In Period

Engine Break-In

Always follow these recommended break-in procedures for new or rebuilt engines. The first tank of fuel is considered the break-in period for the engine.

Premix the first tank of fuel and fill the oil reservoir as outlined below. Oil added to the fuel and oil injection systems will provide the necessary engine lubrication.

Oil Recommendations	
First Tank of Fuel:	POLARIS VES 2-Cycle Oil
After Break-in:	POLARIS VES 2-Cycle Oil

See page 116 for the part numbers of POLARIS products.

Never mix brands of oil. Serious chemical reactions can cause injection system blockage, resulting in serious engine damage. Oils may also be incompatible and the result could be sludge formation, filter blockage, and reduced cold weather flow rates. All POLARIS oils are compatible with each other.

Initial Fuel Premix

Always premix fuel in 5-gallon (19-liter) increments in a separate fuel container. Never add oil directly to the fuel tank.

Fuel	VES 2-Cycle Oil	Ratio
Each 5 gal. (19 l)	16 oz. (473 ml)	40:1

Break-In Period Engine Break-In

Excessive heat build-up during the first three hours of operation will damage close-fitted engine parts. Do not operate at full throttle or high speeds for extended periods during the first three hours of use. Vary the throttle openings and vehicle speeds to reduce friction on all close-fitting machined parts, allowing them to break in slowly without damage.

NOTICE: Use of any lubricants other than those recommended by POLARIS may cause serious engine damage. We recommend the use of POLARIS lubricants for your vehicle.

Drive with extra caution during the break-in period. Perform regular checks on fluid levels, lines, and all other important areas of the snowmobile.

Oil Injection System

Always check and fill the oil bottle when refueling. See page 73.

NOTICE: Serious engine damage can occur without the proper lubrication. Check the oil bottle level often during the first tank of fuel. If the oil level doesn't go down, contact your dealer immediately.

Drive Belt Break-In

The break-in period for a new drive belt is 30 miles (48 km). During this time, vary the throttle position under 50% and limit full throttle use.

Always take time to warm up the belt and driveline prior to operating the snowmobile. Free the track and skis from the ground before engaging throttle.

OPERATION

Track Warm-Up

WARNING! A loose track or flying debris could cause serious injury or death. Stand clear of the front of the snowmobile and the moving track. Never hold the snowmobile up or stand behind it while warming up the track. Do not use excessive throttle during warm-up or when the track is free-hanging. Use a stable rear support.

WARNING! Use of traction products such as studs will increase the possibility of track damage and/or failure. This could cause loss of control, resulting in serious injury or death. Always inspect for track damage before operating the snowmobile.

Follow these steps to ensure proper warm-up of the engine, drive train and track.

1. Never rotate a dry track. For best track performance, always lubricate the track with water or snow before rotating the track.
2. Use an appropriate stand to securely support the rear of the snowmobile at the rear bumper. The track should be about 4 inches (10 cm) off the ground.
3. Start the engine and allow it to warm up two to three minutes.
4. Depress the throttle abruptly and allow the track to rotate several revolutions.

TIP: It will take longer to warm up the track sufficiently during colder outdoor temperatures.

5. Release the throttle, apply the brakes, shut off the engine and lower the snowmobile to the ground.
6. Grasp the skis by their front loops and move them from side to side to loosen snow and ice.

Slide Rail and Track Cooling

NOTICE: Inadequate cooling and lubrication will lead to overheating of the slide rail and track, resulting in premature wear and failure. Reduce speeds and frequently drive into fresh snow to allow adequate cooling and polishing of the slide rail and track surfaces. Avoid operating on ice, hard-packed surfaces or roads.

Fuel

WARNING

Gasoline is highly flammable and explosive under certain conditions.

- Always exercise extreme caution whenever handling gasoline.
- Always refuel outdoors or in a well-ventilated area.
- Always turn off the engine before refueling.
- Do not overfill the tank. Do not fill the tank neck.
- Do not smoke or allow open flames or sparks in or near the area where refueling is performed or where gasoline is stored.
- If gasoline spills on your skin or clothing, immediately wash it off with soap and water and change clothing.
- Never start the engine or let it run in an enclosed area. Engine exhaust fumes are poisonous and can cause loss of consciousness or death in a short time.

WARNING

The engine exhaust from this product contains chemicals known to cause cancer, birth defects or other reproductive harm. Operate this vehicle only outdoors or in well-ventilated areas.

OPERATION

Fuel Recommendation

For peak performance, POLARIS recommends the use of 91 octane fuel or higher. Although 87 octane fuel is usable, some engine performance will be lost and fuel economy will decrease. Do not use lower than 87 octane fuel. *Do not use fuel containing more than 10% ethanol. Never use E85 fuel in your snowmobile.*

NOTICE: Operating with obstructed fuel systems will result in serious engine damage. Perform maintenance as recommended.

Prolonged exposure to petroleum based products may damage paint. Always protect painted surfaces when handling fuel.

Fuel System Deicers

If you use non-ethanol fuel (sometimes labeled “non-oxygenated”), POLARIS recommends the regular use of isopropyl-based fuel system deicer. Add one to two ounces per gallon (8-16 ml per liter) of gasoline to prevent damage resulting from fuel system icing. *Never use deicers or additives containing methanol.* POLARIS recommends the use of Carbon Clean. See page 116 for the part numbers of POLARIS products.

If you use fuel with up to 10% ethanol (sometimes labeled “oxygenated”) do not add deicers or additives that contain any form of alcohol.

Oil

Low Oil Level

Always maintain the oil level between the “add” mark and the bottle neck.

Do not fill the bottle neck. See page 68 for oil recommendations.

1. *Immediately* stop the engine if the low oil indicator light comes on.
2. Open the left side panel.
3. View the oil level in the oil bottle.
4. Add oil as needed before operating.

NOTICE: Operating the snowmobile without adequate engine lubrication can result in serious engine damage. Always check the oil level when refueling. Add oil as needed.

The oil bottle cap is vented to allow proper oil flow. See your POLARIS dealer for recommended replacement parts.



OPERATION

Engine Stop Switch

Push down on the engine stop switch (X) to ground out the ignition and stop the engine quickly. Pull the switch up to the ON position to allow restarting.

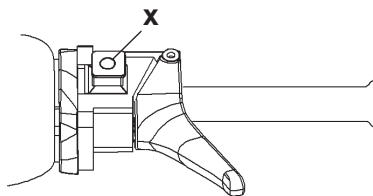

Throttle Safety Switch

The throttle safety switch is designed to stop the engine whenever all pressure is removed from the throttle lever and the throttle cable or valves do not return to the normal closed position.

WARNING! Operating the snowmobile with a faulty throttle safety switch can result in serious injury or death in the event of an accident. If the throttle safety switch does not shut off the engine during a carburetor/throttle system malfunction, immediately push down the engine stop switch. Do not start the engine again until the malfunction has been corrected by your dealer.

Test the throttle safety switch system daily before operation.

1. Sit on the seat.
2. Start the engine and allow it to idle.
3. Hold the throttle lever pin stationary by exerting pressure on the pivot pin in the direction shown in the illustration.
4. Apply a slight amount of throttle. A properly functioning switch must shut down the engine.

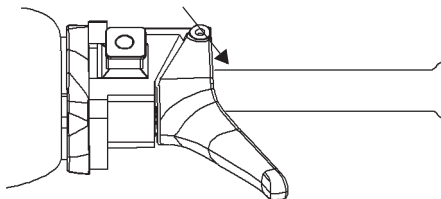

Throttle Lever

WARNING! An improperly functioning throttle lever may cause erratic snowmobile behavior and loss of control, which could result in serious injury or death. If the throttle lever does not work properly, DO NOT start the engine.

If the engine stops abruptly when the throttle lever is released:

1. Turn the ignition switch to OFF.
2. Visually inspect the throttle cable and carburetor/throttle body to determine what caused the safety switch to activate.
3. Test the throttle lever by compressing and releasing it several times. The lever and cable must return to the idle position quickly and completely.
4. If the throttle lever operates properly, turn the ignition switch on and go through normal starting procedures.
5. If the engine doesn't start, take the snowmobile to an authorized POLARIS dealer for service.

Excessive freeplay in the throttle cable may cause the safety switch to activate, preventing the engine from starting. If this occurs, return the snowmobile to an authorized POLARIS dealer for service.

If an emergency exists and it's necessary to start the engine, the throttle safety switch and engine stop switch may be disconnected from the wire harness. When these switches are disconnected, the ignition key switch must be used to shut off the engine. DO NOT continue to operate the snowmobile with the throttle safety switch disconnected. Return the snowmobile to an authorized POLARIS dealer for service as soon as possible.

OPERATION

Emergency Stopping

The following chart lists methods for stopping the snowmobile in the event of an emergency. See page 74 for more information about the engine stop switch and throttle safety switch.

SYSTEM	WHAT IT DOES
Ignition Switch	Interrupts ignition circuit
Brake	Slows jackshaft
Engine Stop Switch	Interrupts ignition circuit
Throttle Safety Switch	Interrupts ignition circuit
Tether Switch (Option)	Interrupts ignition circuit

Electronic Reverse (PERC)

⚠ WARNING

Improper reverse operation, even at low speeds, may cause loss of control, resulting in serious injury or death. Damage will occur to the chaincase if shifting is attempted when the engine is operating above idle speed.

- Shift to or from reverse only when the snowmobile is stopped and when engine speed is at idle.
- Look behind the vehicle before and while backing.
- Avoid sharp turns.
- Apply throttle slowly.

Electronic reverse will activate only if the engine RPM is below 4000.

NOTICE: Engaging the starter when the engine is running WILL result in serious engine damage, especially if the snowmobile is in reverse. Never engage the starter when the engine is running.

OPERATION

Electronic Reverse (PERC)

Engaging Reverse

1. Stop the snowmobile and leave the engine idling.
2. Make sure the area behind your vehicle is clear.
3. Push the yellow reverse button on the left-hand control for one second, then release. The engine will automatically reduce RPM and start a reverse rotation. A flashing reverse light on the instrument panel will indicate that the snowmobile is in reverse.
4. Apply the throttle slowly to make sure the snowmobile is in reverse. The maximum engine RPM will be 6000 when in reverse.

TIP: If the engine stops running, the snowmobile will be in forward gear when it's restarted.

Disengaging Reverse

1. Stop the snowmobile and leave the engine idling.

NOTICE: Engaging the starter when the engine is running WILL result in serious engine damage, especially if the snowmobile is in reverse. Never engage the starter when the engine is running.

2. Push the yellow reverse button for one second and release. The engine will slow and begin to rotate forward. The light on the instrument panel will shut off.
3. Apply the throttle slowly to make sure the snowmobile is in forward.

Daily Storage

At the end of each ride, park the snowmobile on a level surface and support it at the rear with an appropriate track stand. The track should be suspended approximately 4 inches (10 cm) off the ground.

Remove the key and cover the snowmobile.

Towing

For your safety, do not attempt to use a tow hitch until you've read the following warnings and understand the proper hitch functions.

WARNING! Objects towed with a rope have no braking power and can easily collide with the rear of the snowmobile or other objects, resulting in serious injury or death. DO NOT tow toboggans, sleds, saucers, or any type of vehicle with a rope. Only a stiff metal pole connecting the towed object and the tow hitch on the snowmobile should be used. If passengers are to be towed on a toboggan or sled, make sure the pole is at least four feet (1.2 meters) long to prevent any possibility of contact between the snowmobile's track and a person riding in the towed object.

WARNING! Braking distances increase when towing loads. Slow down to maintain control of the snowmobile.

If the snowmobile becomes inoperable and must be towed, and if it isn't possible to use a rigid tow bar, attach the tow rope to the ski spindles (not to the ski loops) to prevent damage to the steering components. Remove the drive belt before towing, and have someone ride on the towed snowmobile to operate the brake and steering when necessary.

NOTICE: Towing a disabled snowmobile with the drive belt in place can result in serious damage to the engine and drive system. Always remove the drive belt from a disabled snowmobile before towing.

MAINTENANCE

Emission Control Information

Any qualified repair shop or qualified person may maintain, replace, or repair the emission control devices or systems on your snowmobile.

Emission Control Label

Your snowmobile is equipped at the time of sale with an emission control information (ECI) label and a factory-installed emissions information hangtag. These items are required by U.S. Environmental Protection Agency regulations. The ECI label is permanently affixed to either the right side of the tunnel or the engine recoil cover. The ECI label should not be removed, even after you purchase the snowmobile. You may remove the factory-installed emissions information hangtag, which is intended solely for your use in making a purchasing decision.

Emission Control Maintenance Requirements

Your snowmobile is certified to operate on gasoline with a minimum octane level of 87 (R+M)/2. If your snowmobile is equipped with a check engine light and it comes on, you must take your snowmobile to a qualified dealer for diagnostic service. Specifications and adjustments for engine tune-ups are located in the Service Manual, which is available to your qualified service technician. Reverse (if equipped) must not be engaged during engine tune-ups.

Owner's Responsibilities

Please read the Snowmobile Engine Emissions Limited Warranty, and read the maintenance section of your owner's manual. You are responsible for ensuring that the specified maintenance is performed. POLARIS recommends that you contact an authorized POLARIS dealer to perform any service that may be necessary.

Non-ionizing Radiation

This vehicle emits some electromagnetic energy. People with active or non-active implantable medical devices (such as heart monitoring or controlling devices) should review the limitations of their device and the applicable electromagnetic standards and directives that apply to this vehicle.

MAINTENANCE

POLARIS Recommended Maintenance Program

To ensure many trouble-free miles of snowmobiling enjoyment, follow recommended regular maintenance and perform service checks as outlined in this manual. Record maintenance and service in the Maintenance Log beginning on page 134.

The recommended maintenance schedule on your snowmobile calls for service and maintenance inspections at 150 miles (240 km), 500 miles (800 km) and 1000 miles (1600 km). These inspections should be performed by a qualified service technician. For continued optimum performance and component life, continue maintenance checks at 1000 mile (1600 km) intervals.

All necessary replacement parts and labor incurred, with the exception of authorized warranty repairs, become the responsibility of the registered owner. If, during the course of the warranty period, part failures occur as a result of owner neglect in performing recommended regular maintenance, the cost of repairs are the responsibility of the owner.

Personal safety is critical when attempting to service or make adjustments to your snowmobile. If you're not familiar with safe service or adjustment procedures and the use of tools, or if you don't feel comfortable performing these tasks yourself, contact an authorized POLARIS dealer for service.

NOTICE: Hot components can cause damage to plastic. Always make sure the exhaust system and engine have cooled before tipping the snowmobile on its side for service or inspection.

MAINTENANCE

Periodic Maintenance Interval Table

The following chart is a guide based on average riding conditions. You may need to increase frequency based on riding conditions. When inspection reveals the need for replacement parts, always use genuine POLARIS parts, available from your POLARIS dealer.

Item	See Page	Frequency				
		150 mi. (240 km)	500 mi. (800 km)	1000 mi. (1600 km)	2000 mi. (3200 km)	Pre-Season
CLUTCH						
Clutch Alignment Offset (without belt)	100		I	I	I	
Drive Belt Condition	101		I	I	I	I
Clutches	100		C	C	C	
Belt Tension	--		I	I	I	I
Clutch Sheaves	100		I	I	I	I
ENGINE/COOLING						
Engine Mounts	84		I	I	I	I
Recoil Rope	--		I	I	I	I
Cylinder Head Bolts	--		I	I	I	
Cylinder Base Nuts	--		I	I	I	
Ignition Timing BTDC	--		I	I	I	
VES System	--		C	C	C	I
Coolant Level	91		I	I	R	I
Coolant Hose	--		I	I	I	I
Coolant Circulation	--		I	I	I	
Coolant Leaks	--		I	I	I	I
Spark Plugs	89		I	I	R	I
Exhaust Pipe	94				I	I
Exhaust Retaining Springs	94		I	I	I	I

I - Inspect (clean, adjust, tighten, lubricate, replace if necessary)

C - Clean R - Replace L - Lubricate

MAINTENANCE

Periodic Maintenance Interval Table

Item	See Page	Frequency				
		150 mi. (240 km)	500 mi. (800 km)	1000 mi. (1600 km)	2000 mi. (3200 km)	Pre-Season
BRAKES						
Hose Routing	--					
Hose Condition	--					
Fluid Leaks	--					
Brake Pads	96					
Brake Disc	--					
Parking Brakes	64					
Brake System	63, 96					
Brake Fluid	97					
FUEL MANAGEMENT						
Idle RPM	--					
Throttle Lever	75					
Oil Pump Lever (synchronize)	--					
Throttle Position Sensor	--					
Fuel Lines	87					
Fuel Filter Replacement	87	EVERY 2000 (3200) or EVERY 2 YEARS				
Oil Filter	90				R	
Oil Lines	90					
Air Box	--					
ELECTRICAL						
Auxiliary Shut-Off Switch	66					
Throttle Safety Switch	74					
Ignition Switch	--					
Taillight	66					
Brakelight	66					
Headlight	66					

MAINTENANCE

Periodic Maintenance Interval Table

Item	See Page	Frequency				
		150 mi. (240 km)	500 mi. (800 km)	1000 mi. (1600 km)	2000 mi. (3200 km)	Pre-Season
CHASSIS						
Ski Toe Alignment	--		I	I	I	
Suspension Mounting Bolts	--	I	I	I	I	I
Bolt Torques	See your dealer every 1000 mi. (1600 km) for inspection					
Steering Fasteners	--	I	I	I	I	C
Rear Suspension Fasteners	--	I	I	I	I	I
Rear Suspension Bushings	112			I	I	I
Suspension Shock Oil	--				R	
Rear Shock Threads	85					L
Cooling Fins and Shroud	--		I	I	I	I
Skags (Wear Bars)	111	I	I	I	I	I
Ski Saddle/Spindle Bolts	--	I	I	I	I	I
Drive Chain Tension	95	I	I	I	I	I
Hood and Side Panel Fasteners	85	I	I	I	I	I
Rear Wheel Idler Bolts	107	I	I	I	I	I
Idler Bolt Jam Nut	107	I	I	I	I	I
Rear Suspension Pivot Shaft	112		L	L		L
Camber Alignment	--		I	I	I	
Handlebar Centering	--					I
Tether Switch and Strap	66	I	I	I	I	I
Track Tension	106	I	I	I	I	I
Track Alignment	108	I	I	I	I	I
Front Limiter Strap	--	I	I	I	I	I
Rail Slide Condition	112					I
Chaincase Oil	86	I	R	I	R	I

I - Inspect (clean, adjust, tighten, lubricate, replace if necessary)

C - Clean R - Replace L - Lubricate

Bolt Torque Inspection

To maintain proper chassis performance, see your POLARIS dealer for a bolt torque inspection every 1000 miles (1600 km).

Item	Description
Engine Mounting Bolts	Remove drive clutch and resonator for access to all bolts
Chaincase Mounting Bolts	Two (2) TORX-head bolts on forward side of chaincase
	Four (4) rear chaincase nuts

Hood/Side Panel

The hood and side panels of the snowmobile protect the operator from moving parts. Never operate a snowmobile with the side panels open or removed. Always ensure that the hood and side panels are securely in place before starting the engine.

To open a side panel, rotate the two 1/4-turn fasteners at the upper edges of the side panel. Release the side panel strap at the lower edge of the panel.

To remove an open side panel, pull the panel outward to release the tabs at the lower edge of the panel.

Removing the hood is not recommended. Any service requiring the removal of the hood should be performed by an authorized POLARIS dealer.

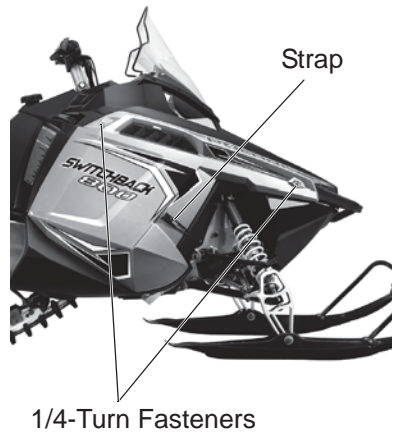

Lubrication

Rear Shock Body Threads

Lubricate rear shock body threads seasonally with a low-temperature synthetic grease.

Driveshaft Bearing

This model has sealed bearings that require no additional lubrication.

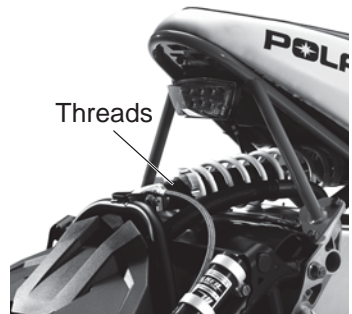

MAINTENANCE

Lubrication

Chaincase Oil

Check and change the chaincase oil at the intervals outlined in the maintenance charts beginning on page 81. Maintain the oil level at the top of the fill plug hole. POLARIS recommends the use of POLARIS Synthetic Chaincase Lube. See page 116 for the part numbers of POLARIS products.

Oil Level

1. Position the vehicle on a level surface.
2. Remove the fill plug.
3. Using a funnel, slowly add the recommended oil until the fluid begins to overflow.
4. Wipe the fill area with a clean cloth.
5. Reinstall the fill plug. Torque to 6-10 ft. lbs. (8-13 Nm).

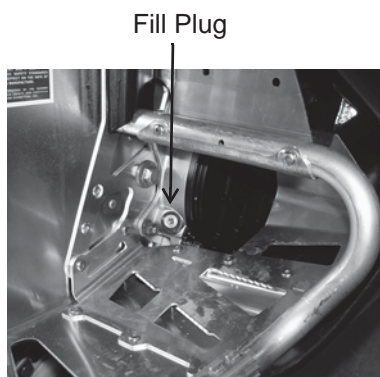

Oil Change

1. Position the vehicle on a level surface.
2. Place a drain pan under the drain plug. Remove the drain plug. Allow the oil to drain completely.
3. Clean off all metal shavings from the plug.

TIP: The sealing surfaces on the drain plug and the oil tank should be clean and free of burrs, nicks or scratches.

4. Reinstall the drain plug. Torque to 6-10 ft. lbs. (8-13 Nm).
5. Remove the fill plug. Clean off all metal shavings from the plug.
6. Using a funnel, slowly add the recommended oil until the fluid begins to overflow. Fluid capacity is 9 oz. (266 ml).
7. Wipe the fill area with a clean cloth.
8. Reinstall the fill plug. Torque to 6-10 ft. lbs. (8-13 Nm).

Intake Filters

The intake foam filters limit snow ingestion into the intake system. When operating in loose powder snow, check the foam filters periodically to remove any accumulation of snow.

Fuel Pump

All fuel pump service must be performed by an authorized POLARIS dealer. Do not attempt to service the fuel pump.

Fuel Filter/Fuel Lines

See your POLARIS dealer for replacement of the fuel filter at the intervals outlined in the Periodic Maintenance Table beginning on page 81.

Contaminated or poor quality fuel will shorten the life of the fuel filter and result in poor engine performance. Always store fuel in clean fuel containers. If low fuel pressure or reduced engine performance occurs between the recommended fuel filter service intervals, the filter may need replacement. See your dealer.

Inspect the fuel lines regularly for signs of deterioration or damage. Always check fuel line condition after periods of storage. Normal deterioration from weather and fuel compounds may occur. Replace worn or damaged fuel lines promptly.

NOTICE: Kinking the fuel lines or using a pliers or similar tools to remove fuel lines may cause damage to the lines. If a fuel line has been damaged or kinked, replace it promptly.

Foam Filters

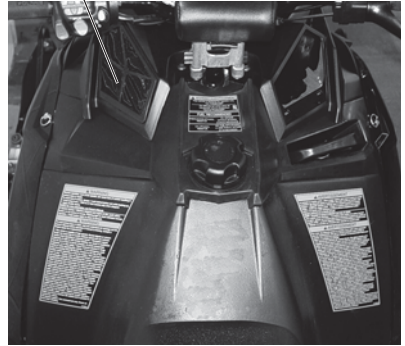

MAINTENANCE

Spark Plugs

Spark Plug Recommendations

A new engine can cause temporary spark plug fouling due to the preservative added during the assembly process. Avoid prolonged idle speeds, which cause plug fouling and carbonization.

Change the spark plugs at the intervals outlined in the Periodic Maintenance Table beginning on page 81. Refer to the specifications section for the specific spark plug to be used in your snowmobile.

- Use recommended spark plugs with the proper gap.
- Use only resistor-type spark plugs.
- Torque spark plugs to 18-22 ft. lbs. (24-30 Nm).
- Always carry spare spark plugs.

NOTICE: Using non-recommended spark plugs can result in serious engine damage. A spark plug with a heat range too high will always cause engine damage if the engine is operated in conditions more severe than intended for that plug. Always use the spark plugs recommended for your snowmobile. Refer to the specifications section beginning on the page 122.

Spark Plugs

Spark Plug Inspection

Spark plug condition is indicative of engine operation. The spark plug firing end condition should be read after the engine has been warmed up and the vehicle has been driven at higher speeds. Immediately check the spark plug for correct color.

CAUTION! A hot exhaust system and engine can cause burns. Wear protective gloves when removing a spark plug for inspection.

1. Remove the left side panel.
2. Remove the spark plug cap.
3. Using the special wrench provided in the tool pouch, rotate the spark plug counter-clockwise to remove.
4. Reverse the procedure for spark plug installation. Torque to specification.
5. Reinstall the spark plug cap.

Spark Plug Condition

Normal Plug

The normal insulator tip is gray, tan or light brown. There will be few combustion deposits. The electrodes are not burned or eroded. This indicates the proper type and heat range for the engine and the service.

Wet Fouled Plug

The wet fouled insulator tip is black. A damp oil film covers the firing end. There may be a carbon layer over the entire nose. Generally, the electrodes are not worn. General causes of fouling are excessive oil or use of non-recommended injection oil.

MAINTENANCE

Oil Lines

Inspect oil line condition every 1000 miles (1600 km).

Oil Filter

Please see your dealer for replacement of the in-line oil filter every 2000 miles (3200 km) as outlined in the maintenance charts beginning on page 81.

Cooling System Coolant

The coolant supplied in the system at the factory is a 50/50 mixture of ethylene-glycol and distilled water, which will provide adequate freeze protection under most conditions. If the vehicle will be stored or operated at extremely low temperatures, greater protection may be required. Please see your POLARIS dealer.

When adding or changing coolant, POLARIS recommends using POLARIS Antifreeze 60/40 Premix. POLARIS Antifreeze is already premixed and ready to use. Do not dilute with water. Never exceed a 60% antifreeze/40% water mixture. See page 116 for POLARIS products.

Never add tap water to the cooling system. Minerals cause deposits and may react adversely with the metals in the engine and cooling system.

Coolant Level

The engine coolant level is controlled by the recovery system. The recovery system components are:

- Coolant bottle/overflow tank
- Pressure cap
- Connecting hoses

Always maintain the coolant level at or slightly above the FULL COLD mark on the coolant bottle (when the engine is cold).

1. Stop the engine.
2. Open the right side panel.
3. View the coolant level in the coolant bottle.
4. Add coolant as needed.

NOTICE: Operating the snowmobile with insufficient coolant will result in overheating and serious engine damage. Always maintain the coolant level as recommended.

“Full Cold” Mark

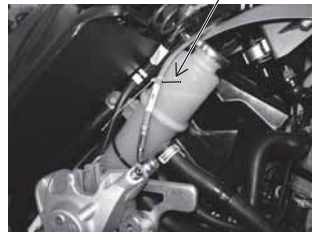

MAINTENANCE

Cooling System

Engine Overheating

The over-temperature indicator on the instrument cluster will *illuminate* when the engine is overheating. The indicator will *flash* when engine temperature reaches critical levels.

Illuminated Indicator

Take action to cool the engine:

- Drive in loose snow.
- View the coolant level. *Do not open the pressure cap while the engine is hot.* Add coolant if the level is low.
- Stop the engine and allow it to cool down.

If you must continue to operate while the indicator light is *illuminated*, drive slowly and stop the engine frequently to allow it to cool down.

Flashing Indicator

If the indicator *flashes*, continued operation could result in serious engine damage. The system will automatically reduce engine power and create a misfire condition. Stop the engine *immediately*. Allow the engine to cool down.

If engine overheating seems to be caused by something other than poor cooling conditions, see your dealer for service.

Flushing the Cooling System

To ensure that the coolant maintains its ability to protect the engine, drain the system completely every two years and add a fresh mixture of antifreeze and distilled water. This service must be performed when the engine is cold. Ask your POLARIS dealer to check the coolant when he performs the fall tune-up on your snowmobile.



Cooling System

Bleeding the Cooling System

CAUTION! Steam and hot liquids will cause burns to your skin. Never bleed the cooling system or remove the pressure cap when the engine is warm or hot.

Use of a non-standard pressure cap will not allow the recovery system to function properly. If the pressure cap needs replacement, contact your dealer for the correct part.

NOTICE: Severe engine damage may occur if the cooling system becomes restricted or plugged or contains trapped air pockets.

Perform this procedure in a well-ventilated area. Use the recommended coolant. See page 91.

1. Open the side panels and remove the hood.
2. Close the side panels.

WARNING! Never operate a snowmobile with the side panels open or removed.

3. Position the vehicle with the right ski and control arms elevated at a 45-degree angle.
4. Fill the coolant bottle to the COLD FILL mark.
5. Using an 8mm wrench, loosen the air bleed screw located on the top of the coolant outlet elbow. Use a shop towel to catch any coolant that leaks from the bleeder. Tighten the screw after a steady stream of coolant flows from the bleeder.
6. Fill the coolant bottle to the COLD FILL mark.
7. Install the coolant bottle cap to the first lock. Do not tighten to the fully seated position.
8. Lock the parking brake.
9. Start the engine and run at a fast idle for several minutes, until the heaters are warm to the touch. Loosen the bleed screw occasionally to purge any trapped air.
10. When all heater extrusions are warm to the touch, stop the engine.
11. Allow the engine and cooling system to cool.
12. Fill the coolant bottle to the COLD FILL mark.
13. Carefully lower the front end of the snowmobile.
14. Secure the bleed screw and reinstall the pressure cap.
15. Open the side panels and reinstall the hood. Close the side panels.

MAINTENANCE

Exhaust System

Check the exhaust system for wear or damage at approximately 2000 miles (3200 km). Always allow the engine and exhaust system to cool completely before inspecting.

CAUTION! Hot exhaust system parts can cause burns. Allow adequate time for the exhaust system to cool. Never perform this procedure with the engine running.

1. Open the side panels and remove the hood. See page 85.
2. Inspect the muffler and pipes for cracks or damage.
3. Check for weak or missing retaining springs or damper/support grommets.
4. Check for loose clamps on the pipe covers.
5. Reinstall the hood and side panels.

Drive Chain Tension

Check drive chain tension at the intervals outlined in the maintenance charts beginning on page 81 and before each long trip.

1. Remove the side panels.
2. Rotate the driven clutch counter-clockwise to move all chain slack to the tensioner side. Lock the brake lever lock, or have an assistant hold the brake lever firmly.
3. Loosen the adjuster bolt jam nut.
4. Finger tighten the adjuster bolt until it can no longer be adjusted by hand, then back off 1/4 turn.
5. Tighten the jam nut while holding the adjuster bolt. Torque to 21 ft. lbs. (28 Nm).
6. Reinstall the side panels.
7. Release the brake lever lock.

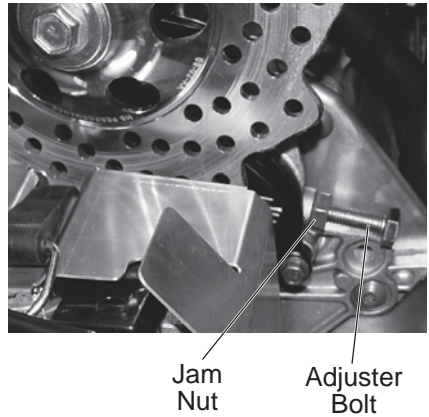

Jam Nut

Adjuster Bolt

MAINTENANCE

Brakes

Hydraulic Brake Inspection

Inspect the brake lever reserve before each use of the snowmobile. See page 63.

Brake pads must be replaced when the brake pad material becomes thinner than the backing plate (approximately 1/16 inch or 1.5 mm). A kit is available for replacing brake pads. See your dealer.

WARNING! Brake failure during operation can result in serious injury or death. Properly functioning brakes are vital to your safety. Be sure the brake pads do not drag on the disc and that brake lever travel is not excessive. Always replace brake pads when the brake pad material becomes thinner than the backing plate (approximately 1/16 inch or 1.5 mm).

Brake Components

1. Brake Caliper
2. Brake Disc
3. Brake Pad Material (Replace when thickness is less than 1/16 inch/1.5 mm).

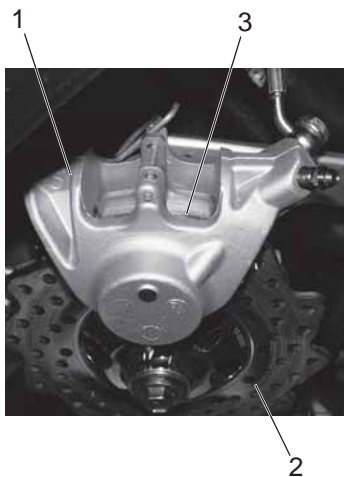

Excessive Lever Travel

Hydraulic brakes are self-adjusting, but if excessive brake pad clearance develops, bring the snowmobile to an authorized POLARIS dealer for inspection and adjustment.

Brakes

Brake Fluid

The brake fluid level can be seen through a plastic sight glass in the brake reservoir. If the fluid is sufficient, the sight glass will be black. If the sight glass is any color other than black, add brake fluid.

Replace brake fluid at least every two years with POLARIS DOT 4 high temperature brake fluid. See page 116 for the part numbers of POLARIS products.

WARNING! After opening a bottle of brake fluid, always discard any unused portion. Never store or use a partial bottle. Brake fluid is hygroscopic, meaning it rapidly absorbs moisture from the air. The moisture causes the boiling temperature of the brake fluid to drop, which can lead to early brake fade and the possibility of accident or serious injury.

WARNING! Keep the master cylinder cover free of dirt and debris. The vent slits allow for diaphragm movement, and if they become plugged, movement of brake fluid below the diaphragm may be restricted, altering brake function.

NOTICE: Brake fluid will damage labels, paint and some plastics. Always wipe up spills immediately.

MAINTENANCE

Brakes

Bleeding the Hydraulic Brake System

Air in the hydraulic brake system will cause spongy brake lever action. Bleed the system before operating the snowmobile.

WARNING! Operating the vehicle with a spongy brake lever can result in loss of brakes, which could cause an accident and lead to serious injury or death. Never operate the vehicle with a spongy-feeling brake lever.

During the bleeding procedure, keep the brake handle as level as possible. The reservoir must be in this position to minimize the possibility of air entering the system through the reservoir vent.

1. Remove the brake master cylinder reservoir cover and gasket.
2. Fill the master cylinder reservoir to between the MIN and MAX marks or 1/4-5/16 inch (.6-.8 cm) below the lip of the reservoir opening. Reinstall the gasket and cover.
3. Slip a rubber tube over the ball of the bleeder valve and direct the flow of fluid into an approved container.
4. Squeeze the brake lever a full stroke. Then unscrew the bleeder valve 3/4 of a turn to release air.
5. Close the bleeder valve and release the brake lever.
6. Repeat steps 4 and 5 until fluid flows from the bleeder valve in a solid stream free of air bubbles.

WARNING! Overfilling the master cylinder leaves no room for fluid expansion and may cause the brakes to lock, resulting in serious injury or death. Always add brake fluid to the fill line as recommended.

7. After bleeding is complete, refill the reservoir to the proper level. See page 97.
8. Reinstall the gasket and cover.

Lights

When servicing a halogen lamp, avoid touching the lamp with bare fingers. Oil from your skin leaves a residue, causing a hot spot that will shorten the life of the lamp. If fingers do touch a lamp, clean it with denatured alcohol.

Headlight Lamp Replacement

1. Remove the wire harness connector from the back of the headlight.
2. Grasp the bulb housing and turn it *counter-clockwise* to remove the bulb.
3. Apply dielectric grease to the socket and install the new bulb. Rotate the bulb 1/4 turn clockwise to secure it.
4. Reinstall the connector to the back of the headlight.

Taillight/Brake Light Replacement

The taillight assembly is not serviceable. If the light fails to operate properly, replace the entire taillight assembly.

MAINTENANCE

Clutch System

Periodically inspect clutch sheaves for damage, wear or belt residue. To maintain optimum performance, clean with non-oil based cleaners such as isopropyl alcohol.

WARNING! If you become aware of higher than normal clutch engagement or an unusual vibration or shift pattern, see your dealer immediately. Do not operate the snowmobile until repairs have been made.

All clutch maintenance and repairs must be performed by an authorized POLARIS dealer. Any unauthorized modifications to clutches, such as adding or removing weights, will void the warranty.

NOTICE: The bushings in the weights and rollers of POLARIS clutches are made of a material that may be damaged if lubricated. Do not lubricate clutch bushings.

Clutch Alignment Offset

Clutch alignment offset is important for maintaining optimum performance. See your dealer for service and adjustments. A special tool is required to check for proper alignment.

Clutch System

Drive Belt Condition

Periodically check the condition and tension of the drive belt. Inspect the belt for signs of excessive wear: frayed edges, missing cogs, cracks and excessive looseness. Replace the belt if any of these conditions exist. See Drive Belt Troubleshooting on page 121.

Always carry a spare drive belt. Store the spare belt in the belt clip located under the left side of the hood. Make sure the o-ring is installed over the belt clip.



For improved drive-away during extremely cold temperatures, remove the belt and warm it to room temperature. Reinstall it before starting the snowmobile.

MAINTENANCE

Clutch System

Drive Belt Deflection

Measure belt deflection with both clutches at rest and in their full neutral position.

Place a straight edge (1) on the belt and apply downward pressure while measuring at point 2. This measurement should be 1 1/4 inches (3.2 cm).

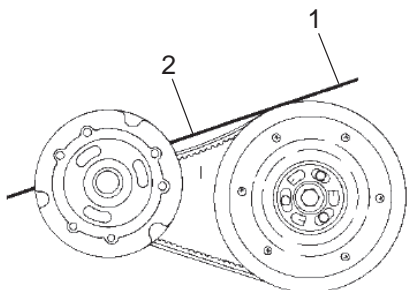

Drive Belt Adjustment

1. Loosen the 7/16-inch jam nut on the belt width adjuster.
2. Using a 1/8-inch Allen wrench, turn the set screw inward (clockwise) to increase the distance between the sheaves or outward (counter-clockwise) to decrease the distance.
3. Tighten the jam nut.

Clutch System

Drive Belt Removal

NOTICE: Do not attempt to remove the drive belt after operating in reverse. The snowmobile must be stopped after forward motion to prevent damage to components during belt removal. Rotate the driven clutch counter-clockwise 1/4 turn by hand to ensure forward engagement before attempting to remove the belt.

1. Stop the engine after operating in a forward motion.
2. Turn the ignition key off. Wait for the engine to come to a complete stop.
3. Lock the parking brake.
4. Remove the left side panel.
5. Rotate the driven clutch counter-clockwise 1/4 turn by hand to ensure forward engagement.
6. Locate the L-wrench in the tool kit. Install the wrench into the open threaded hole in the outer sheave of the clutch.
7. Turn the wrench clockwise until the sheaves open far enough to remove the belt. If the wrench does not turn readily, rotate the driven clutch counter-clockwise an additional 1/4 turn by hand and try again.
8. Firmly grasp the belt midway between the clutches and pull upward and rearward to remove it.

MAINTENANCE

Clutch System

Drive Belt Installation

1. Drop the drive belt over the drive clutch and pull back the slack. The belt cord line should be flush with, or slightly above, the outer circumference of the driven clutch sheaves. The belt will seat itself in the driven clutch during the break-in period. Adjust the belt ride-out after the break-in period by readjusting belt deflection.
2. To ensure satisfactory belt life, install belts so they operate in the same direction of rotation by positioning the identification numbers so that you can read them. If required, separate the sheaves as outlined in the belt removal procedures.
3. Turn the driven clutch moveable sheave clockwise while pushing inward and forcing the belt down between the sheaves.
4. Hold the belt down between the sheaves and roll the bottom portion over the outer clutch sheave. Work the belt to the outer edge of the sheave.
5. Rotate the L-wrench to tighten the sheaves. Remove the wrench and store in the tool kit.
6. Reinstall the side panel.
7. Break in the new belt. See page 69.

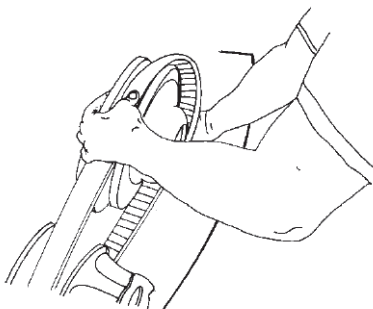

Track Maintenance

Track Inspection

WARNING! Broken track rods can cause a rotating track to come off the snowmobile, which could cause serious injury or death. Never operate with a damaged track. Never rotate a damaged track under power.

1. Using a hoist, safely lift and support the rear of the snowmobile off the ground.
2. Rotate the track by hand to check for damage.
3. Carefully examine the track along the entire length of each rod (X). Bend the track to check for breakage.
4. Replace the track if any rod damage is found.

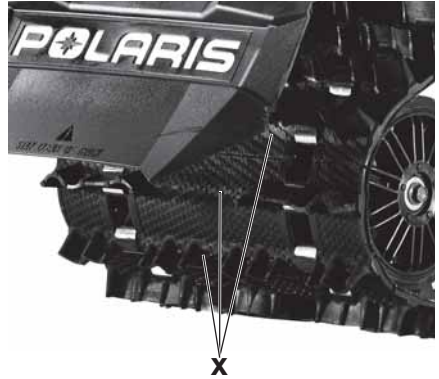

Track Lubrication

The slide rail needs snow for lubrication. Excessive wear indicates insufficient lubrication. A new rail slide can cause faster heat build-up in limited lubrication, resulting in excessive wear.

WARNING! Operating with insufficient lubrication between the rail slide and track guide clips can cause track failure, loss of vehicle control and loss of braking ability, which can result in serious injury or death. Avoid operating for extended periods on ice and other surfaces that have little or no snow for lubrication.

If excessive rail slide wear occurs due to poor snow conditions, additional wheel kits may be available. See your dealer for more information.

Track damage or failure caused by operation on ice or under other poor lubrication conditions will void the track warranty.

MAINTENANCE

Track Maintenance

WARNING! Moving parts can cut and crush body parts. When performing the checks and adjustments recommended on the following pages, stay clear of all moving parts. Never perform track measurement or adjustments with the engine running.

Track Tension

Track adjustment is critical for proper handling. Always maintain correct tension and alignment.

TRACK TENSION DATA CHART			
Suspension	Slack Measurement	Weight	Measurement Location
SWITCHBACK 136	1/4-3/8 inch (6.3-9.6 mm)	10 lbs. (4.54 kg)	16 inches (40 cm) ahead of rear idler shaft

TIP: Tension adjustments should be made only after the track is warmed up and limber.

1. Turn the engine off.

NOTICE: Do not use the rear bumper to lift the rear of the snowmobile for track adjustments.

2. Lift the rear of the snowmobile by the chassis (seat support, x-brace or running boards) until the track is slightly above the ground. Safely support the rear of the snowmobile in this position.
3. Place the recommended weight or downward pressure on the track at the specified distance (see chart) ahead of the center of the rear idler wheel.
4. Measure at the point where the weight is hanging.

Track Maintenance

Track Tension

5. Check for specified slack between the wear surface of the track clip and the plastic slider. Refer to the Track Tension Data Chart on page 106.

If the track needs adjustment:

6. Loosen the rear idler shaft bolt.
7. Loosen the locknuts.

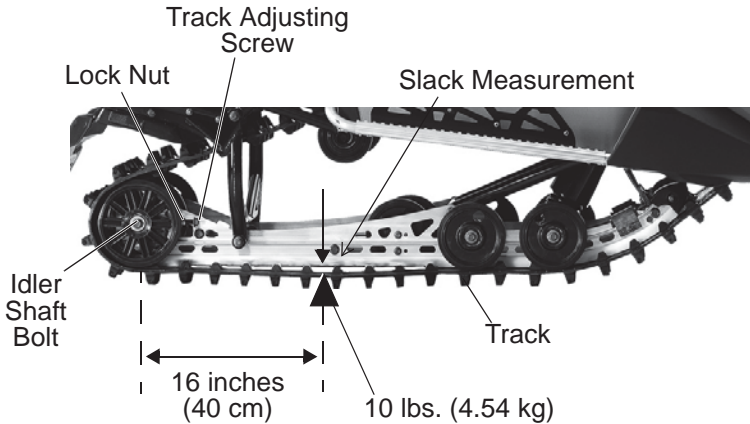

8. Tighten or loosen the track adjusting screws to provide equal adjustment on both sides of the track.
9. Repeat the measurement on the other side of the track.

TIP: Check more frequently when the snowmobile is new.

10. Remove the weight. Start the engine and slowly rotate the track at least five revolutions. Let the track come to a stop (do not apply brakes).
11. Check track alignment (see page 108) and adjust as necessary.
12. Tighten the locknuts.
13. Tighten idler shaft bolts to 35 ft. lbs. (47.5 Nm).

MAINTENANCE

Track Maintenance

Track Alignment

Periodically check that the track is centered and running evenly on the slide rails. Misalignment will cause excessive wear to the track and slide rail.

1. Safely support the rear of the snowmobile with the track off the ground.
2. Start the engine and apply a small amount of throttle until the track turns slowly at least five complete revolutions. Stop the engine and let the track come to a stop (do not apply brakes).
3. Inspect track alignment by looking through the track window to make sure the rails are evenly spaced on each side. If the track runs to the left, loosen the idler shaft bolts, then loosen the left locknut and tighten the left adjusting bolt. If the track runs to the right, loosen the idler shaft bolts, then loosen the right locknut and tighten the right adjusting bolt.
4. After adjustments are complete, tighten the locknuts and torque idler shaft bolts to 35 ft. lbs. (47.5 Nm).
5. Repeat steps 2 and 3 to verify proper alignment.

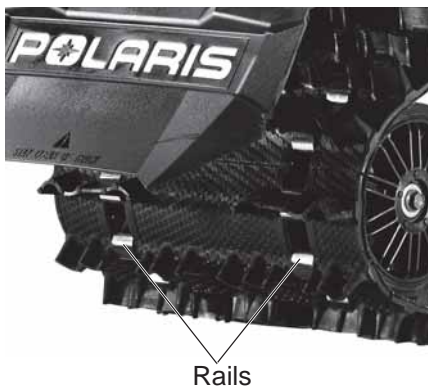

Steering System Front Suspension Inspection

Each week, or before a long ride, check all steering system fasteners and tighten if necessary.

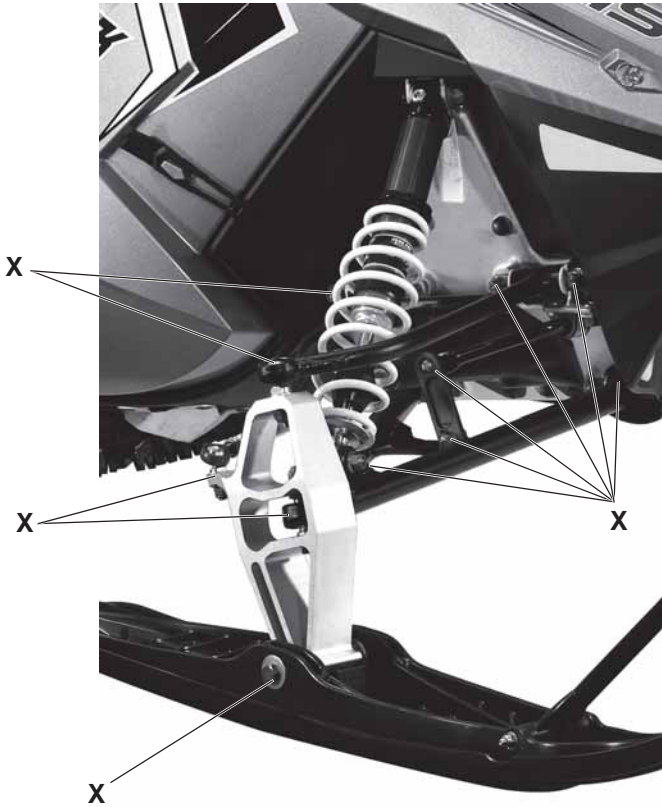

MAINTENANCE

Steering System

Ski Alignment

WARNING! Improper ski alignment or adjustment may cause loss of steering control, resulting in serious injury or death. Do not attempt to change the ski alignment or camber adjustment. See your POLARIS dealer.

1. Place the handlebars in a straight-ahead position.
2. With only vehicle weight compressing the suspension, measure 10 inches (25.4 cm) forward from the center of the ski mounting bolt. See illustration. At this point, measure between the skis. This is measurement X.
3. Perform the same measurement rearward from the center of the ski mounting bolt. This is measurement Y.
4. The X measurement should be 1/8-1/4 inch (3-6 mm) greater than the Y measurement. If the skis are misaligned, see your dealer for alignment correction as camber adjustment may also be affected.

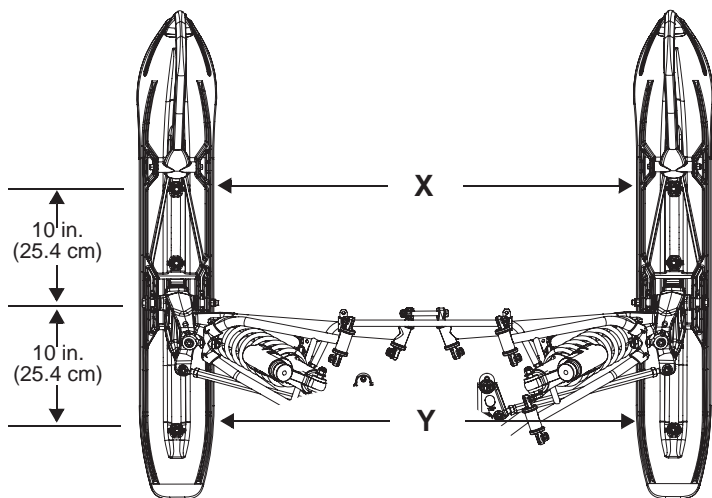

Steering System

Ski Skags

WARNING! Worn skis and/or skags will adversely affect handling. Loss of vehicle control may result, causing serious injury or death. See your dealer's studding chart for recommended skags. If you install longer or more aggressive carbide skags than the original equipment, it may also be necessary to add track studs to maintain proper vehicle control while turning on hard-packed snow or ice.

Check skags before each use of the snowmobile to ensure positive steering characteristics. Skags must be replaced when worn to half their original diameter.

TIP: Carbide skags must be replaced if any abnormal wear or chipping is found.

Skag Replacement

Some models are equipped with single skags. Some models are equipped with dual skags.

1. Raise and support the front of the snowmobile so the skis are approximately 6 inches (15.2 cm) from the ground.
2. Remove the attaching nuts and pry the skag downward.
3. Remove the front end of the skag.
4. Remove the rear end of the skag.
5. Reverse the steps to install a skag.

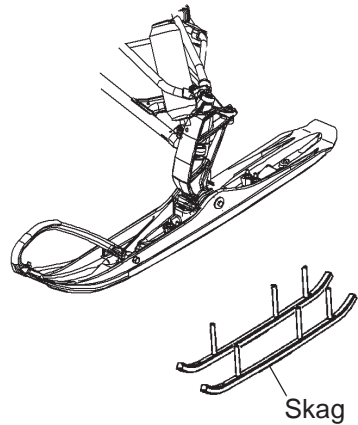

MAINTENANCE

Steering System

Rail Slide Wear

Measure slide thickness at several points along the rail. Have your dealer replace the slide when it's worn down to the top of the wear limit indicator groove (X). Do not operate the snowmobile if slide thickness measures less than 7/16 inch (1.1 cm).



Rear Suspension

Lubricate the suspension pivot shaft with Polaris All Season Grease every 1000 miles (1600 km) and before seasonal storage.

Inspect the rear suspension bushings (X) at the intervals outlined in the Periodic Maintenance Table beginning on page 81. Inspect more often if the snowmobile is frequently operated in extreme conditions. Replace bushings when they show evidence of wear.

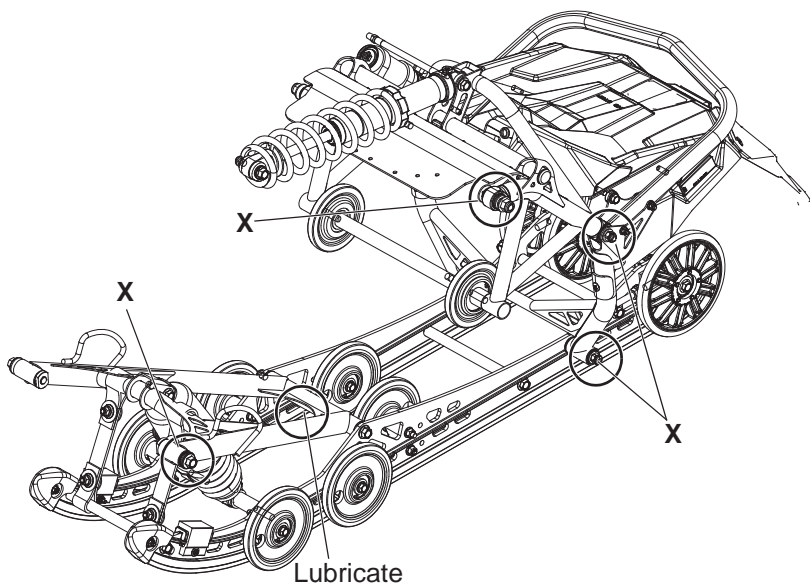

Fall Tune-Up

For maximum performance, arrange for a fall service tune-up with your POLARIS dealer. His experienced and trained service technician will keep your snowmobile in peak operating condition.

Matte Clear Coat Cleaning (if equipped)

Matte finish products are prone to trapping dirt, oils and other contaminants. POLARIS Industries recommends cleaning with warm water and a mild dish detergent. Use a soft sponge to gently rub the surface and rinse with clean warm water. For stubborn stains such as grease or oil use a citrus based cleaner (3M Citrus Base Cleaner recommended). Spray onto the area to be cleaned and rub with a soft sponge. Allow to sit for a couple of minutes and wash away with clean warm water. Repeat as necessary to clean the surface.

NOTICE: Never use a polishing/buffing wax or any sponge that has an abrasive surface. These products will buff the matte surface of the finish resulting in a glossy finish. It is not recommended that you clean matte finishes with a pressure washer as this will further imbed contaminants into the clear coat and possibly damage the labels.

MAINTENANCE

Extended Storage

Off-season or extended storage of your snowmobile requires preventive measures to aid against deterioration and to prolong the useful life of many components. See page 116 for the part numbers of POLARIS products.

Cleaning and Preservation

Proper storage starts with cleaning, washing, and waxing the hood, side panels, chassis, and plastic parts. Wipe down remaining surfaces with a damp cloth. Clean and touch up with paint any rusted or previously painted surfaces. Be sure that corrosive salt and acids are removed from surfaces before beginning preservation with waxes and rust inhibitors (grease, oil or paint).

The snowmobile should be stored in a dry garage or shed, out of direct sunlight, and covered with a fabric snowmobile cover. Plastic tarp may cause condensation to form and damage snowmobile components.

Extended Storage Clutch and Drive System

Remove the drive belt and store in a cool dry location. Do not lubricate clutch components, except the driven clutch shaft bushing as outlined in the Master Repair Manual. See your dealer.

Engine Protection

Proper preparation of the engine and fuel system is vital to the prevention of rust and corrosion on precision engine parts during storage. Whenever the snowmobile is stored for a period of more than 60 days, the engine must be fogged with fogging oil. Follow the engine fogging instructions provided on the container.

Always add Carbon Clean or a fuel conditioner/stabilizer to the fuel tank. Follow the instructions on the container, running the engine for five minutes to get additives through the entire fuel system. Top off with fresh fuel. *Do not allow the snowmobile to run out of fuel.*

Electrical Connections

Replace worn or frayed electrical wire and connectors. Be sure wiring harness is properly secured away from sharp edges, steering linkage, moving parts, and hot exhaust parts.

Track and Suspension

Moderate track tension should be maintained during summer storage. The snowmobile should be supported off the ground to allow the track to hang freely.

Transporting the Snowmobile

Whenever the snowmobile is transported:

1. Be sure the fuel cap and oil cap are installed correctly.
2. Tie the snowmobile to the transporting unit securely using suitable straps.
3. Remove the ignition key to prevent loss.

POLARIS PRODUCTS

Part No.	Description
Engine Lubricants	
2870791	Fogging Oil (12 oz. Aerosol)
2877882	VES 2-Cycle Oil (qt./.95 l)
2877953	VES 2-Cycle Engine Oil (2 qt./1.9 l)
2877883	VES 2-Cycle Engine Oil (gal./3.8 l)
2877884	VES 2-Cycle Engine Oil (2.5 gal./9.5 l)
Chaincase Lubricants	
2873105	SCL - Synthetic Chaincase Lubricant (qt./.95 l)
2873106	SCL - Synthetic Chaincase Lubricant (gal./3.8 l)
Grease/Specialized Lubricants	
2871312	Grease Gun Kit, All Season (3 oz./89 ml)
2871322	All Season Grease (3 oz./89 ml cartridge)
2871423	All Season Grease (14 oz./414 ml cartridge)
2871329	Dielectric Grease (Nyogel™)
Coolant	
2871534	Polaris Antifreeze 60/40 Premix (qt./.95 l)
2871323	Polaris Antifreeze 60/40 Premix (gal./3.8 l)
Additives/Miscellaneous	
2871326	Carbon Clean
2870652	Fuel Stabilizer
2872189	DOT 4 Brake Fluid
2872893	Engine Degreaser
2870505	Isopropyl Fuel De-Icer
2872889	Brake and Clutch Cleaner
2872890	Carb and Throttle Body Cleaner

TROUBLESHOOTING

Engine Troubleshooting

Unless you have experience and training in two-cycle engine repair, see your dealer if technical problems arise.

Problem	Probable Cause	Solution
Erratic engine operating RPM during acceleration or load variations	Drive clutch binding	• SEE YOUR DEALER.
	Driven clutch malfunction	• SEE YOUR DEALER.
Harsh drive clutch engagement	Drive belt worn or too narrow	• Replace the drive belt.
	Excessive belt/sheave clearance	• SEE YOUR DEALER.
Drive belt turns over	Wrong belt for application	• Replace the drive belt.
	Clutch alignment out of spec	• SEE YOUR DEALER.
	Engine mount broken or loose	• Inspect and replace. SEE YOUR DEALER.
Machine fails to move	Clutch jammed	• Check for twisted belt or broken spring. SEE YOUR DEALER.
	Track jammed	• Foreign object may be caught or the rail slide melted to the track clips due to lack of lubrication. • Track may be iced up or frozen to the ground.
	Chaincase sprocket or chain jammed or broken	• Chain is loose or broken or chain tightener is loose. SEE YOUR DEALER.

TROUBLESHOOTING

Engine Troubleshooting

Problem	Probable Cause	Solution
Noise in drive system	Broken drive clutch components	• SEE YOUR DEALER.
	Bearing failure/chaincase, jackshaft, or front drive shaft	• SEE YOUR DEALER.
	Drive belt surface flat spots	• Inspect and replace as needed.
	Drive chain loose	• Inspect and adjust (or replace).
	Drive chain worn, sprocket teeth broken	• SEE YOUR DEALER.
Poor low RPM performance	Worn drive belt	• Inspect and replace as needed.
	Excessive belt/sheave clearance	• SEE YOUR DEALER.
	Sticky clutch	• SEE YOUR DEALER.
	Poor fuel quality	• Use 87-91 octane fuel (or higher).
Engine doesn't turn	Seized engine	• SEE YOUR DEALER. Seizure is a result of poor lubrication, inadequate fuel supply, broken parts or improper cooling.
	Hydrostatic lock	• Fuel may have entered the crankcase while the vehicle was standing or being transported. SEE YOUR DEALER to correct the cause. Drain plug(s) are located on the lower crankcase for emergency draining.

TROUBLESHOOTING

Engine Troubleshooting

Problem	Probable Cause	Solution
Engine turns but fails to start	Faulty ignition	<ul style="list-style-type: none">• Install new spark plug(s). If engine still fails to start, check for spark. If there's no spark, SEE YOUR DEALER.
	No fuel to engine	<ul style="list-style-type: none">• Make sure the fuel valve is on.• Make sure the fuel tank contains fuel.• Ice may be in the fuel line, filter or pump. Add isopropyl alcohol to the fuel system.
	Poor engine compression	<ul style="list-style-type: none">• This indicates a major engine problem that must be repaired before operating. SEE YOUR DEALER.
Engine lacks power	Fouled or defective spark plug(s)	<ul style="list-style-type: none">• Replace the plug(s).
	Fuel filter (loss of high RPM power)	<ul style="list-style-type: none">• SEE YOUR DEALER.
	Plugged fuel filter or tank pick-up sock	<ul style="list-style-type: none">• SEE YOUR DEALER.
	Incorrect clutching	<ul style="list-style-type: none">• SEE YOUR DEALER.
Engine continually backfires	Faulty plug(s)	<ul style="list-style-type: none">• Change plug(s), ensure caps are seated.
	Fuel System	<ul style="list-style-type: none">• Dirt or ice may be in the fuel system (deicer should be added to non-ethanol fuel at all times for assurance against fuel line icing).
	Incorrect throttle freeplay or faulty switch	<ul style="list-style-type: none">• SEE YOUR DEALER.
Engine requires more than normal pulls to start	Poor fuel	<ul style="list-style-type: none">• Replace with fresh winter fuel.
	Not enough fuel getting to engine	<ul style="list-style-type: none">• SEE YOUR DEALER.
	Plugged fuel filter or tank pick-up sock	<ul style="list-style-type: none">• SEE YOUR DEALER.

TROUBLESHOOTING

Suspension Troubleshooting

Problem	Solution
Rear suspension bottoms too easily	<ul style="list-style-type: none"> • Adjust rear shock spring (see pages 47 and 55). • Change rear shock spring (see your dealer). • Revalve rear track shock (see your dealer).
Rides too stiff in rear	<ul style="list-style-type: none"> • Check for binding suspension shafts and grease all pivot points. • Adjust rear shock spring (see pages 47 and 55). • Change rear shock spring (see your dealer). • Check track tension (see page 106).
Too much weight transfer when climbing	<ul style="list-style-type: none"> • Adjust rear shock spring (see pages 47 and 55).
Too little weight transfer when climbing	<ul style="list-style-type: none"> • Adjust rear shock spring (see pages 47 and 55).
Machine darts from side to side	<ul style="list-style-type: none"> • Check ski alignment (see page 110). • Make sure spindles and all steering components turn freely. • Check for excessive play in steering assembly (see your dealer). • Ensure skags are straight on skis. • Adjust rear shock spring (see pages 47 and 55). • Check rail slide/replace if worn (see page 112). • Install Accu-Trak dual skags (see your dealer).
Front end pushes	<ul style="list-style-type: none"> • Check for worn skags. • Adjust rear shock spring (see pages 47 and 55). • Check for binding front suspension shafts and steering components, grease all pivot points (elevate front of snowmobile). • Increase IFS preload (if equipped) (see page 51). • Install single skag (see your dealer).
Steering is heavy	<ul style="list-style-type: none"> • Make sure spindles and all steering components turn freely. • Check ski alignment (see page 110). • Check skags and skis for damage. • Adjust rear shock spring (see pages 47 and 55).

TROUBLESHOOTING

Drive Belt Troubleshooting

Belt Wear/Burn Diagnosis	
Causes	Solutions
Driving at low RPM	<ul style="list-style-type: none">• Drive at higher RPMs. Gear the machine down. Check belt deflection.
Insufficient warm-up	<ul style="list-style-type: none">• Warm the engine at least five minutes. Take the drive belt off the snowmobile in extremely cold weather and warm it up. Break snowmobile loose from the snow.
Towing at low RPM	<ul style="list-style-type: none">• Do not tow in deep snow. Use fast, aggressive throttle to engage clutch.
Riding with high RPM and slow speed (8000 RPM/10 MPH/16 km/h)	<ul style="list-style-type: none">• Lower the gear ratio. Reduce RPM. Avoid riding in high ambient temperatures. Check for snow ingestion.
Ice and snow build-up between track and tunnel	<ul style="list-style-type: none">• Warm the engine at least five minutes. Take the drive belt off the snowmobile in extremely cold weather and warm it up. Break snowmobile loose from the snow.
Poor engine performance	<ul style="list-style-type: none">• Check for fouled plugs and water, ice or dirt in the fuel tank or fuel line.
Loading snowmobiles onto trailers	<ul style="list-style-type: none">• Skis may gouge into trailers and prevent the drivetrain from spinning properly. Use enough speed to drive the snowmobile completely onto the trailer. Push and pull it to finish loading if necessary.
Clutch malfunction	<ul style="list-style-type: none">• Inspect clutch components. See your dealer.
Slow, easy clutch engagement	<ul style="list-style-type: none">• Use fast, aggressive throttle to engage clutch.

SPECIFICATIONS

600 SWITCHBACK

Capacities and Dimensions	
Body Style	PRO-RIDE
Rider Capacity	1
Coolant Capacity	5 qts. (4.7 l)
Chaincase Oil Capacity	9 oz. (266.2 ml)
Fuel Tank Capacity	11 gal. (41.6 l)
Gearcase Oil Capacity (oz./ml)	N/A
Oil Capacity (qts./l)	3.8 qts. (3.6 l)
Height	46 inches (117 cm)
Length	115 inches (292 cm)
Designed Width (in./cm)	48 inches (122 cm)
Brake Type	Hayes Phantom
Drive Clutch Center Distance	11.5 inches (29 cm)
Drive Belt P/N	3211122
Clutch Type	P-85
Reverse Transmission	Electronic Reverse
Engine and Cooling	
Engine	S4771-6044-OR6G
Displacement	599 cc
Cylinders	2
Bore x Stroke (mm)	77.25 x 64
Alternator Output	400 watt
Throttle Body	Mikuni
Oil Injection	VES
Throttle Body Bore Size	46 mm
Idle RPM	1700 +/- 200
Cooling	Liquid
Ignition Type	Digital
Ignition Timing	18° @ idle 1700 RPM w/120°F (49°C) water temp
Spark Plug / Gap	NGK BPR9ES /.027 inches (0.7 mm)
Recommended Fuel Octane	91 Recommended (87 Minimum)

SPECIFICATIONS

600 SWITCHBACK (Non-Electric Start Models)

Clutching Chart					
ALTITUDE Meters (Feet)	Drive Clutch Shift Weight	Drive Clutch Spring	Driven Clutch Spring	Driven Helix	Chaincase Gearing/ Pitch
*Shaded cells indicate factory settings.					
0-600 (0-2000)	10-64 (1321585)	120/310 Black (7043681)	130/180 P2 Tab (7043873)	(58/42/.45) P2N (5137176)	22:40 72 Pitch
600-1200 (2000-4000)	10-62 (1321586)	120/310 Black (7043681)	130/180 P2 Tab (7043873)	(58/42/.45) P2N (5137176)	22:40 72 Pitch
1200-1800 (4000-6000)	10-60 (1321587)	120/310 Black (7043681)	130/180 P2 Tab (7043873)	(58/42/.45) P2N (5137176)	22:40 72 Pitch
1800-2400 (6000-8000)	10-58 (1321588)	120/310 Black (7043681)	130/180 P2 Tab (7043873)	(58/42/.45) P2N (5137176)	22:40 72 Pitch
2400-3000 (8000-10000)	10-56 (1321684)	120/310 Black (7043681)	130/180 P2 Tab (7043873)	(58/42/.45) P2N (5137176)	20:41 72 Pitch
3000-3600 (10000-12000)	10 AL (1321531)	120/310 Black (7043681)	130/180 P2 Tab (7043873)	(58/42/.45) P2N (5137176)	20:41 72 Pitch

600 SWITCHBACK (Electric Start Models)

Clutching Chart					
ALTITUDE Meters (Feet)	Drive Clutch Shift Weight	Drive Clutch Spring	Driven Clutch Spring	Driven Helix	Chaincase Gearing/ Pitch
*Shaded cells indicate factory settings.					N.A. / INTL
0-600 (0-2000)	10-64 (1321585)	Black/Green (7042083)	130/180 P2 Tab (7043873)	(58/42/.45) P2N (5137176)	22:40 21:41 (INTL) 72 Pitch
600-1200 (2000-4000)	10-62 (1321586)	Black/Green (7042083)	130/180 P2 Tab (7043873)	(58/42/.45) P2N (5137176)	22:40 21:41 (INTL) 72 Pitch
1200-1800 (4000-6000)	10-60 (1321587)	Black/Green (7042083)	130/180 P2 Tab (7043873)	(58/42/.45) P2N (5137176)	22:40 21:41 (INTL) 72 Pitch
1800-2400 (6000-8000)	10-58 (1321588)	Black/Green (7042083)	130/180 P2 Tab (7043873)	(58/42/.45) P2N (5137176)	22:40 21:41 (INTL) 72 Pitch
2400-3000 (8000-10000)	10-56 (1321684)	Black/Green (7042083)	130/180 P2 Tab (7043873)	(58/42/.45) P2N (5137176)	20:41 72 Pitch
3000-3600 (10000-12000)	10 AL (1321531)	Black/Green (7042083)	130/180 P2 Tab (7043873)	(58/42/.45) P2N (5137176)	20:41 72 Pitch

SPECIFICATIONS

800 SWITCHBACK

Capacities and Dimensions	
Body Style	PRO-RIDE
Rider Capacity	1
Coolant Capacity	5 qts. (4.7 l)
Chaincase Oil Capacity	9 oz. (266.2 ml)
Fuel Tank Capacity	11 gal. (41.6 l)
Gearcase Oil Capacity (oz./ml)	N/A
Oil Capacity (qts./l)	3.8 qts. (3.6 l)
Height	46 inches (117 cm)
Length	115 inches (292 cm)
Designed Width (in./cm)	48 inches (122 cm)
Brake Type	Hayes Phantom
Drive Clutch Center Distance	11.5 inches (29 cm)
Drive Belt P/N	3211115
Clutch Type	P-85
Reverse Transmission	Electronic Reverse
Engine and Cooling	
Engine	S4774-8044-OR8G
Displacement	794 cc
Cylinders	2-Monoblock
Bore x Stroke (mm)	85 x 70
Alternator Output	400 watt
Throttle Body	Mikuni
Oil Injection	VES
Throttle Body Bore Size	48 mm
Idle RPM	1700 +/- 200
Cooling	Liquid
Ignition Type	Digital
Ignition Timing	18° @ idle 1700 RPM w/120°F (49°C) water temp
Spark Plug / Gap	NGK BPR9ES /.027 inches (0.7 mm)
Recommended Fuel Octane	91 Recommended (87 Minimum)

SPECIFICATIONS

800 SWITCHBACK (1.25" or 1.35" Lug Height)

Clutching Chart						
ALTITUDE Meters (Feet)	Drive Clutch Shift Weight	Drive Clutch Spring	Driven Clutch Spring	Driven Helix	Chaincase Gearing/ Pitch	
*Shaded cells indicate factory settings.					N.A.	INTL
0-600 (0-2000)	10-66 (1321584)	120/310 Black (7043681)	LH BLUE/BLACK Team (7043064)	(64/42/.36) LW ER (5135401)	22:36 70 Pitch	21:41 72 Pitch
600-1200 (2000-4000)	10-64 (1321585)	120/310 Black (7043681)	LH BLUE/BLACK Team (7043064)	(64/42/.36) LW ER (5135401)	22:36 70 Pitch	21:41 72 Pitch
1200-1800 (4000-6000)	10-62 (1321586)	120/310 Black (7043681)	LH BLUE/BLACK Team (7043064)	(64/42/.36) LW ER (5135401)	22:36 70 Pitch	21:41 72 Pitch
1800-2400 (6000-8000)	10-60 (1321587)	120/310 Black (7043681)	LH BLK/PUR TEAM LW (7043363)	(64/42/.36) LW ER (5135401)	22:36 70 Pitch	21:41 72 Pitch
2400-3000 (8000-10000)	10-60 (1321587)	140/330 (7043342)	LH BLK/PUR TEAM LW (7043363)	(64/42/.36) LW ER (5135401)	20:38 70 Pitch	20:41 72 Pitch
3000-3600 (10000-12000)	10-58 (1321588)	140/330 (7043342)	LH BLK/PUR TEAM LW (7043363)	(64/42/.36) LW ER (5135401)	20:38 70 Pitch	20:41 72 Pitch

800 SWITCHBACK (1.75" Lug Height)

Clutching Chart					
ALTITUDE Meters (Feet)	Drive Clutch Shift Weight	Drive Clutch Spring	Driven Clutch Spring	Driven Helix	Chaincase Gearing/ Pitch
*Shaded cells indicate factory settings.					N.A. / INTL
0-600 (0-2000)	10-66 (1321584)	120/310 Black (7043681)	LH BLUE/BLACK Team (7043064)	(64/42/.36) LW ER (5135401)	21:41 72 Pitch
600-1200 (2000-4000)	10-64 (1321585)	120/310 Black (7043681)	LH BLUE/BLACK Team (7043064)	(64/42/.36) LW ER (5135401)	21:41 72 Pitch
1200-1800 (4000-6000)	10-62 (1321586)	120/310 Black (7043681)	LH BLUE/BLACK Team (7043064)	(64/42/.36) LW ER (5135401)	21:41 72 Pitch
1800-2400 (6000-8000)	10-60 (1321587)	120/310 Black (7043681)	LH BLK/PUR TEAM LW (7043363)	(64/42/.36) LW ER (5135401)	21:41 72 Pitch
2400-3000 (8000-10000)	10-60 (1321587)	140/330 (7043342)	LH BLK/PUR TEAM LW (7043363)	(64/42/.36) LW ER (5135401)	20:41 72 Pitch
3000-3600 (10000-12000)	10-58 (1321588)	140/330 (7043342)	LH BLK/PUR TEAM LW (7043363)	(64/42/.36) LW ER (5135401)	20:41 72 Pitch

WARRANTY

Service and Warranty Information

Obtaining Service and Warranty Assistance

Read and understand the service data and the POLARIS warranty information contained in this manual. Contact your POLARIS dealer for replacement parts, service or warranty. Your dealer receives frequent updates on changes, modifications and tips on snowmobile maintenance, which may supersede information contained in this manual. Your dealer is also familiar with POLARIS policies and procedures and will be happy to assist you.

When contacting us about parts, service, or warranty, always provide the following information:

1. Serial number
2. Model number
3. Dealer name
4. Date of purchase
5. Details of trouble experienced
6. Length of time and conditions of operation
7. Previous correspondence

Use the page provided near the front of your Owner's Manual to record the identification numbers of your snowmobile and its engine.

POLARIS Customer Service

United States: 1-888-704-5290

Canada: 1-204-925-7100

POLARIS Anti-Theft System

The POLARIS anti-theft system (PATS) monitoring program is designed to aid owners of registered snowmobiles in recovery of stolen machines.

Administration

1. POLARIS snowmobile owner reports theft.
 - A. In addition to notifying the proper law enforcement officials, the owner must call POLARIS Customer Service.
 - B. Owners must provide their name, address, telephone number and the model and serial number of stolen machines.
2. POLARIS warranty will provide all dealerships with a monthly updated list of all stolen units to further monitor thefts.
3. POLARIS warranty will aid in notifying the proper owner when a unit is recovered.

WARRANTY

Limited Warranty

POLARIS Sales Inc., 2100 Highway 55, Medina, MN 55340, provides a ONE YEAR LIMITED WARRANTY on all components of the POLARIS snowmobile against defects in material or workmanship. Warranty period will vary regionally. This warranty covers the parts and labor charges for repair or replacement of defective parts that are covered by this warranty. The warranty begins on the date of purchase. This warranty is transferable to another consumer, during the warranty period, through a POLARIS dealer.

Registration

At the time of sale, the Warranty Registration Form must be completed by your dealer and submitted to POLARIS within ten days. Upon receipt of this registration, POLARIS will record the registration for warranty. No verification of registration will be sent to the purchaser as the copy of the Warranty Registration Form will be the warranty entitlement. If you have not signed the original registration and received the customer copy, please contact your dealer immediately. **NO WARRANTY COVERAGE WILL BE ALLOWED UNLESS THE SNOWMOBILE IS REGISTERED WITH POLARIS.**

Initial dealer preparation and setup of your snowmobile is very important in ensuring trouble-free operation. Purchasing a snowmobile in the crate or without proper dealer setup will void your warranty coverage.

Warranty Coverage and Exclusions

Limitations of warranties and remedies

This warranty excludes any failures not caused by a defect in material or workmanship. The warranty does not cover accidental damage, normal wear and tear, abuse or improper handling. The warranty also does not cover any snowmobile that has been structurally altered, neglected, improperly maintained, used for racing or used for purposes other than for which it was manufactured. The warranty does not cover any damages that occur during trailer transit or as a result of unauthorized service or parts. In addition, this warranty does not cover physical damage to paint or finish, stress cracks, tearing or puncturing of upholstery material, corrosion or defects in parts, components or the snowmobile due to fire, explosions or any other cause beyond POLARIS' control.

This warranty does not cover the use of unauthorized lubricants, chemicals, or fuels that are not compatible with the snowmobile.

The exclusive remedy for breach of this warranty shall be, at POLARIS' exclusive option, repair or replacement of any defective materials, or components or products. **THE REMEDIES SET FORTH IN THIS WARRANTY ARE THE ONLY REMEDIES AVAILABLE TO ANY PERSON FOR BREACH OF THIS WARRANTY. POLARIS SHALL HAVE NO LIABILITY TO ANY PERSON FOR INCIDENTAL, CONSEQUENTIAL OR SPECIAL DAMAGES OF ANY DESCRIPTION, WHETHER ARISING OUT OF EXPRESS OR IMPLIED WARRANTY OR ANY OTHER CONTRACT, NEGLIGENCE, OR OTHER TORT OR OTHERWISE. THIS EXCLUSION OF CONSEQUENTIAL, INCIDENTAL, AND SPECIAL DAMAGES IS INDEPENDENT FROM AND SHALL SURVIVE ANY FINDING THAT THE EXCLUSIVE REMEDY FAILED OF ITS ESSENTIAL PURPOSE.** Some states do not permit the exclusion or limitation of incidental or consequential damages or implied warranties, so the above limitations or exclusions may not apply to you if inconsistent with controlling state law.

WARRANTY

Limitations of warranties and remedies

ALL IMPLIED WARRANTIES (INCLUDING BUT NOT LIMITED TO THE IMPLIED WARRANTIES OF MERCHANTABILITY AND FITNESS FOR A PARTICULAR PURPOSE) ARE LIMITED IN DURATION TO THE ABOVE ONE YEAR WARRANTY PERIOD. POLARIS FURTHER DISCLAIMS ALL EXPRESS WARRANTIES NOT STATED IN THIS WARRANTY. Some states do not allow limitations on how long an implied warranty lasts, so the above limitation may not apply to you if inconsistent with controlling state law.

Promotional Warranties

Promotional warranties are sometimes offered by POLARIS. These warranties can be, but are not limited to:

- Two-year extended engine coverage
- Two-year powertrain coverage
- Extended service contract

If you selected any type of extended warranty coverage as part of a POLARIS retail program, please contact any authorized POLARIS dealer for additional information.

How to Obtain Warranty Service

If your snowmobile requires warranty service, you must take it to a POLARIS dealer authorized to repair POLARIS snowmobiles. When requesting warranty service you must present your copy of the Warranty Registration form to the dealer. (The cost of transportation to and from the dealer is YOUR responsibility). POLARIS recommends that you use your original selling dealer; however, you may use any POLARIS Servicing Dealer to perform warranty service.

Please work with your dealer to resolve any warranty issues. Your dealer will contact the appropriate personnel at POLARIS if additional assistance is needed.

This warranty gives you specific legal rights, and you may also have other rights which vary from state to state.

If any of the above terms are void because of state or federal law, all other warranty terms will remain in effect.

Engine Oil

1. Mixing oil brands or using non-recommended oil may cause engine damage. We recommend the use of POLARIS engine oil.
2. Damage resulting from the use of non-recommended lubricants may not be covered by warranty.

WARRANTY

Conditions and Exclusions

In order to qualify for warranty, the product must have been properly set up and tested by a POLARIS Dealer (if applicable). Failure of any dealer to perform the required vehicle Pre-Delivery Inspection, perform all applicable service bulletins and have the consumer sign the PDI form prior to delivery may void the warranty. Failure to provide proof of required periodic maintenance upon request may result in denial of warranty coverage. Use of the recommended POLARIS products for lubrication and maintenance as directed by the Owner's manual is highly recommended. Should a failure occur during the warranty period resulting from the use of non-recommended products, warranty coverage may be denied.

Warranty does not apply to parts exposed to friction surfaces, stresses, environmental conditions and/or contamination. The following items are excluded from warranty consideration if the failure was due to wear or not the direct result of a defect:

Skis	Ski wear rods
Tracks	Slide rails
Suspension components	Finished and unfinished surfaces
Brake components	Carburetor/Throttle body components
Seat components	Engine components
Clutches and components	Drive belts
Steering components	Hydraulic components
Batteries	Circuit breakers/Fuses
Light bulbs/Sealed beam lamps	Electronic components
Idler wheels	

Warranty applies to the product only and does not allow for coverage of personal loss. Some items are considered "consumable," meaning they are considered part of normal maintenance or part of completing an effective repair. The following items are excluded from warranty coverage in the event of a warranty claim:

Spark Plugs	Lubricants such as oil, grease, etc.
Filters	Batteries (unless defective)
Fuel	Cosmetic damage/repair
Sealants	Coolants
Hotel fees	Meals
Towing charges	Shipping/ handling fees
Mileage	Product pick-up/delivery
Rentals/Loss of product use	Loss of vacation/personal time

This warranty also excludes failures resulting from improper lubrication; improper engine timing; improper fuel; surface imperfections caused by external stress, heat, cold or contamination; operator error or abuse; improper component alignment, tension, adjustment or altitude compensation; failure due to snow, water, dirt or other foreign substance ingestion/contamination; improper maintenance; modified components; use of aftermarket components resulting in failure; unauthorized repairs; repairs made after the warranty period expires or by an unauthorized repair center; use of the product in competition or for commercial purposes. Warranty will not apply to any product which has been damaged by abuse, accident, fire or any other casualty not determined a defect of materials or workmanship.

WARRANTY

Exported Vehicles

EXCEPT WHERE SPECIFICALLY REQUIRED BY LAW, THERE IS NO WARRANTY OR SERVICE BULLETIN COVERAGE ON THIS VEHICLE IF IT IS SOLD OUTSIDE THE COUNTRY OF THE SELLING DEALER'S AUTHORIZED LOCATION.

This policy does not apply to vehicles that have received authorization for export from POLARIS Industries. Dealers may not give authorization for export. You should consult an authorized dealer to determine this vehicle's warranty or service bulletin coverage if you have any questions.

This policy does not apply to vehicles registered to government officials or military personnel on assignment outside the country of the selling dealer's authorized location.

This policy does not apply to Safety Bulletins.

How to Get Service

In the Country where your vehicle was purchased:

Warranty or Service Bulletin repairs must be done by an authorized POLARIS dealer. If you move or are traveling within the country where your vehicle was purchased, Warranty or Service Bulletin repairs may be requested from any authorized POLARIS dealer who sells the same line as your vehicle.

Outside the Country where your vehicle was purchased:

If you are traveling temporarily outside the country where your vehicle was purchased, you should take your vehicle to an authorized POLARIS dealer. You must show the dealer photo identification from the country of the selling dealer's authorized location as proof of residence. Upon residence verification, the servicing dealer will be authorized to perform the warranty repair.

Exported Vehicles

How to Get Service

If You Move:

If you move to another country, be sure to contact POLARIS Customer Assistance and the customs department of the destination country before you move. Vehicles importation rules vary considerably from country to country. You may be required to present documentation of your move to POLARIS Industries in order to continue your warranty coverage. You may also be required to obtain documentation from POLARIS Industries in order to register your vehicle in your new country. You should warranty register your vehicle at a local POLARIS dealer in your new country immediately after you move to continue your warranty coverage and to ensure that you receive safety information and notices regarding your vehicle.

If Purchased From A Private Party:

If you purchase a POLARIS product from a private citizen outside of the country in which the vehicle was originally purchased, all warranty coverage will be denied. You must nonetheless warranty register your vehicle under your name and address with a local POLARIS dealer in your country to ensure that you receive safety information and notices regarding your vehicle.

Notice

If your vehicle is registered outside of the country where it was purchased, and you have not followed the procedure set out above, your vehicle will no longer be eligible for warranty or service bulletin coverage of any kind, other than *safety* bulletins. (Vehicles registered to Government officials or military personnel on assignment outside of the country where the vehicle was purchased will continue to be covered by the basic warranty.)

For questions call POLARIS Customer Assistance (see page 126).

WARRANTY

U.S.A. EPA Emissions Limited Warranty

This emissions limited warranty is in addition to the POLARIS standard limited warranty for your vehicle. POLARIS Industries Inc. warrants that at the time it is first purchased, this emissions-certified vehicle is designed, built and equipped so it conforms with applicable U.S. Environmental Protection Agency emission regulations. POLARIS warrants that the vehicle is free from defects in materials and workmanship that would cause it to fail to meet these regulations.

The warranty period for this emissions-certified vehicle starts on the date the vehicle is first purchased and continues for a period of 200 hours of engine operation, 4000 kilometers (2485 miles) of vehicle travel, or 30 calendar months from the date of purchase, whichever comes first.

This emissions limited warranty covers components whose failure increases the vehicle's regulated emissions, and it covers components of systems whose only purpose is to control emissions. Repairing or replacing other components not covered by this warranty is the responsibility of the vehicle owner. This emissions limited warranty does not cover components whose failure does not increase the vehicle's regulated emissions.

For exhaust emissions, emission-related components include any engine parts related to the following systems:

- Air-induction system
- Fuel system
- Ignition system
- Exhaust gas recirculation systems

The following parts are also considered emission-related components for exhaust emissions:

- Aftertreatment devices
- Crankcase ventilation valves
- Sensors
- Electronic control units

The following parts are considered emission-related components for evaporative emissions:

- Fuel Tank
- Fuel Cap
- Fuel Line
- Fuel Line Fittings
- Clamps*
- Pressure Relief Valves*
- Control Valves*
- Control Solenoids*
- Electronic Controls*
- Vacuum Control Diaphragms*
- Control Cables*
- Control Linkages*
- Purge Valves
- Vapor Hoses
- Liquid/Vapor Separator
- Carbon Canister
- Canister Mounting Brackets
- Carburetor Purge Port Connector

*As related to the evaporative emission control system.

WARRANTY

U.S.A. EPA Emissions Limited Warranty

The exclusive remedy for breach of this limited warranty shall be, at the exclusive option of POLARIS, repair or replacement of any defective materials, components or products. THE REMEDIES SET FORTH IN THIS LIMITED WARRANTY ARE THE ONLY REMEDIES AVAILABLE TO ANY PERSON FOR BREACH OF THIS WARRANTY. POLARIS SHALL HAVE NO LIABILITY TO ANY PERSON FOR INCIDENTAL, CONSEQUENTIAL OR SPECIAL DAMAGES OF ANY DESCRIPTION, WHETHER ARISING OUT OF EXPRESS OR IMPLIED WARRANTY OR ANY OTHER CONTRACT, NEGLIGENCE OR OTHER TORT OR OTHERWISE. THIS EXCLUSION OF CONSEQUENTIAL, INCIDENTAL, AND SPECIAL DAMAGES IS INDEPENDENT FROM AND SHALL SURVIVE ANY FINDING THAT THE EXCLUSIVE REMEDY FAILED OF ITS ESSENTIAL PURPOSE.

ALL IMPLIED WARRANTIES (INCLUDING BUT NOT LIMITED TO ANY IMPLIED WARRANTIES OF MERCHANTABILITY AND FITNESS FOR A PARTICULAR PURPOSE) ARE LIMITED IN DURATION TO THE WARRANTY PERIOD DESCRIBED HEREIN. POLARIS DISCLAIMS ALL EXPRESS WARRANTIES NOT STATED IN THIS WARRANTY. Some states do not allow limitations on how long an implied warranty lasts, so the above limitation may not apply if it is inconsistent with the controlling state law.

This limited warranty excludes failures not caused by a defect in material or workmanship. This limited warranty does not cover damage due to accidents, abuse or improper handling, maintenance or use. This limited warranty also does not cover any engine that has been structurally altered, or when the vehicle has been used in racing competition. This limited warranty also does not cover physical damage, corrosion or defects caused by fire, explosions or other similar causes beyond the control of POLARIS.

Owners are responsible for performing the scheduled maintenance identified in the owner's manual. POLARIS may deny warranty claims for failures that have been caused by the owner's or operator's improper maintenance or use, by accidents for which POLARIS has no responsibility, or by acts of God.

Any qualified repair shop or person may maintain, replace, or repair the emission control devices or systems on your vehicle. POLARIS recommends that you contact an authorized POLARIS dealer to perform any service that may be necessary for your vehicle. POLARIS also recommends that you use only Pure POLARIS parts. It is a potential violation of the Clean Air Act if a part supplied by an aftermarket parts manufacturer reduces the effectiveness of the vehicle's emission controls. Tampering with emission controls is prohibited by federal law.

If you have any questions regarding your warranty rights and responsibilities, please contact the POLARIS Warranty Department at 1-888-704-5290.

MAINTENANCE LOG

Present this section of your manual to your dealer each time your snowmobile is serviced. This will provide you and future owners with an accurate log of maintenance and services performed on the snowmobile.

DATE	MILES (KM)	TECHNICIAN	SERVICE PERFORMED / COMMENTS
	150 mi. (240 km)		
	500 mi. (800 km)		
	1000 mi. (1600 km)		
	2000 mi. (3200 km)		

MAINTENANCE LOG

DATE	MILES (KM)	TECHNICIAN	SERVICE PERFORMED / COMMENTS

MAINTENANCE LOG

DATE	MILES (KM)	TECHNICIAN	SERVICE PERFORMED / COMMENTS

A

Accessories	57
Air Pollution	6
Avalanches	15

B

Belt Break-In.	69
Brake Lever Travel Inspection	63
Brakelight Replacement	99
Brakes	63, 96-98
Brake Fluid	97
Components	96
Inspection	96
Lever Travel	96
System Bleeding	98
Break-In Period.	68-69

C

Carbide Skags	59
Chaincase Oil	86
Cleaning for Matte Finishes	113
Cleaning/Preservation for Storage	114
Clicker, Front Track Shock.	54
Clicker, IFS Shock	52
Clicker, Rear Shock	55
Clutch Alignment Offset.	100
Clutch Safety.	18
Clutch System.	100-104
Clutch Warning.	21
Clutch/Drive System Storage	115
Clutching Charts	
600 SWITCHBACK.	123
800 SWITCHBACK.	125
Cold Weather Drive-Away	18
Compression Damping, FT Shock	54
Compression Damping, IFS Shock.	52
Coolant	91
Coolant Level	91
Cooling System.	91-93
Cooling System, Bleeding	93
Cooling System, Flushing.	92
Customer Service	126

D

DET.	28-29
Detonation Elimination.	28-29
Diagnostic Display Codes.	44-45
Diagnostic Display Mode	43
Disabled Operators	12
Display, Standard/Metric	36
Drive Belt	
Break-In	69
Adjustment	102
Condition	101
Deflection	102
Installation	104
Removal	103
Drive Chain Tension.	95
Driver Awareness	14
Driveshaft Bearing Lubrication	85
Driving Downhill	17
Driving in Hilly Terrain	17
Driving on Slippery Surfaces	16
Driving Responsibly	19

E

Electrical Connections for Storage.	115
Emission Control Information	80
Emissions Limited Warranty	132-133
Engine Break-In	68-69
Engine Overheating	92
Engine Protection for Storage.	115
Engine Restarting	67
Engine Safety	10
Engine Starting	67
Engine Stop Switch.	74
Environment Preservation	6
Exhaust System.	94

F

Fasteners, Hood and Side Panel	65
Fluid Change	
Chaincase	86
Coolant	92

INDEX

F

Fluid Level	
Brake Fluid	97
Chaincase	86
Coolant	91
Front Suspension Inspection	109
Fuel	71
Fuel Filter	87
Fuel Lines	87
Fuel Premix (Initial Fill)	68
Fuel Pump	87
Fuel Recommendation	72
Fuel System Deicers	72
Fuel Type Selection	27
Fuel Warnings	71

G

Guide, Suspension Set-Up	46-49
------------------------------------	-------

H

Handlebar Adjustments	56
Handlebar Angle	56
Handlebar Position	56
Headlight Adjustment	26
Headlight Lamp Replacement	99
Hood Fasteners	65
Hood/Side Panel Access	85

I

Ice and Snow Build-up	16
IFS	50
IFS Adjustment Options	50
IFS Components	50
Ignition Lock System	29, 37-42
Inadequate Snow Conditions	16
Independent Front Suspension	50
Indicator Lights	31
Information Display Area	34
Inspection, Pre-Ride	60
Instrument Cluster	30-45
Intake Filters	87
Intake Silencer	18

L

Lights	
Headlight Replacement	99
Taillight/Brake Light	99
Lubrication	85-86

M

Maintenance Interval Table	82-84
Maintenance Program	81
Maintenance Recommendations	9
Maneuverability	18
Matte Finish Cleaning	113
Metric/Standard Display	36

N

Noise	6
-----------------	---

O

Odometer/Engine Hour Display	35
Oil Change, Chaincase	86
Oil Filter	90
Oil Injection System	69
Oil Level, Chaincase	86
Oil Level, Injection	73
Oil Lines	90
Oil Recommendations	68
Operating in Deep Snow	16
Operation Warning	23
Operator Safety	8-20
Overheating, Engine	92

P

Parking Brake Lever Lock	64
Passenger Warning	22
Playback Function	35
Polaris Products and Part Numbers	116
Preload, Front Track Shock Spring	54
Preload, IFS Shock Spring	51
Preload, Rear Shock Spring	55
Pre-Ride Checklist	60
Pre-Ride Suspension Inspection	61
Pressure Cap Warning	21

INDEX

R

Rail Slide Wear	112
Recoil Rope Inspection	65
Registration, Warranty	127
Reverse Operation	77-78
Reverse Warning	22
Rider Capacity	13
Rider Information Center	32-45
Riding Apparel	11
Riding Position	10

S

Safety Labels	21-23
Safety Symbols	8
Security System	29, 37-42
Set-Up Guide, Suspension	46-49
Shock Clicker, Rear Shock	55
Shock Lubrication, Rear Shock	85
Shock Springs, Rear	48
Shock Valving, IFS	52
Side Panel Access	85
Side Panel Fasteners	65
Signal Words	8
Skags	59
Ski Alignment	110
Ski Skags	111
Slide Rail and Track Cooling	70
Snow Conditions	16
Spark Plug Condition	89
Spark Plug Inspection	89
Spark Plug Recommendations	88
Spark Plugs	88-89
Speed	13
Speed Display	34
Spring Guide, Rear Shock	48
Spring Preload, Front Track Shock	54
Spring Preload, IFS Shock	51
Spring Preload, Rear Shock	55
Standard/Metric Display	36
Starting the Engine	67
Starting the Engine, Restarting	67
Steering System	109-112
Steering System Inspection	65
Stopping, Emergency	76
Storage Procedures	114-115

S

Storage, Daily	79
Studs	58
Survival Preparation	127
Suspension Adjustments, Front	50-52
Suspension Adjustments, Rear	53-55
Suspension Inspection, Pre-Ride	61
Suspension Inspection, Rear	112
Suspension Performance Tips	53
Suspension Quick Set-Up Guide	46-49

Switches

Engine Stop Switch	74
Mode/Select Buttons	30
Mode/Set Switch	30
Throttle Safety Switch	74

T

Taillight/Brakelight Replacement	99
Throttle Lever	75
Throttle Lever Inspection	62
Throttle Safety Switch	74
Throttle Safety Switch Inspection	62
Towing	79

Track

Alignment	108
Inspection	105
Lubrication	105
Tension	106-107
Track Care for Storage	115
Track Inspection	65
Track Maintenance	105-108
Track Safety	10
Track Tension	53
Track Warm-Up	70
Track Warning	22
Traction Products	58-59
Transporting the Snowmobile	115
Troubleshooting, Drive Belt	121
Troubleshooting, Engine	117-119
Troubleshooting, Suspension	120
Tune-Up	113

V

Vehicle Identification Numbers	7
--	---

W

Wear Strips	59
Windchill	20

For your nearest Polaris dealer, call 1-800-POLARIS
or visit www.polaris.com
Polaris Sales Inc.,
2100 Hwy. 55, Medina, MN 55340
Phone 1-888-704-5290
Part No. 9924269 Rev 01 Printed in USA



POLARIS®

